



AIRPLANE FLIGHT MANUAL

DA 42

Airworthiness Category : Normal
Requirement : JAR-23
Serial Number : _____
Registration : _____
Doc. No. : 7.01.05-E
Date of Issue : 29 April 2004

Signature : 
ACG Project Manager : 
Stamp : AUSTRO CONTROL GmbH
Abteilung Flugtechnik
Zentrale
A-1030 Wien, Schnirchgasse 11
Date of approval : 25. Okt. 2005

This Flight Manual has been verified for EASA by the Austrian Civil Aviation Authority Austro Control (ACG) as Primary Certification Authority (PCA) in accordance with the valid Certification Procedures and approved by EASA with approval no 2004-4703.

| This Airplane Flight Manual is FAA approved for U.S. registered aircraft in accordance
| with the provisions of 14 CFR Section 21.29, and is required by FAA Type Certificate Data
| Sheet no.: A57CE

DIAMOND AIRCRAFT INDUSTRIES GMBH
N.A. OTTO-STR. 5
A-2700 WIENER NEUSTADT
AUSTRIA

NOTE

This airplane flight manual is valid for DA42 airplanes with a KAP 140 or no autopilot system installed.

Refer to the airplane flight manual “DA42 with Garmin GFC 700 (OÄM 42-102)”, Doc. No. 7.01.06-E for airplanes with a Garmin Autopilot system installed.

FOREWORD

We congratulate you on the acquisition of your new DIAMOND DA 42 Twin Star.

Skillful operation of an airplane increases both safety and the enjoyment of flying. Please take the time therefore, to familiarize yourself with your new DIAMOND DA 42.

This airplane may only be operated in accordance with the procedures and operating limitations of this Airplane Flight Manual.

Before this airplane is operated for the first time, the pilot must familiarize himself with the complete contents of this Airplane Flight Manual.

In the event that you have obtained your DIAMOND DA 42 second-hand, please let us know your address, so that we can supply you with the publications necessary for the safe operation of your airplane.

This document is protected by copyright. All associated rights, in particular those of translation, reprinting, radio transmission, reproduction by photo-mechanical or similar means and storing in data processing facilities, in whole or part, are reserved.

Copyright © by: DIAMOND AIRCRAFT INDUSTRIES GMBH
N.A. Otto-Strasse 5
A-2700 Wiener Neustadt, Austria
Phone : +43-2622-26700
Fax : +43-2622-26780
E-Mail : office@diamond-air.at

0.1 APPROVAL

The content of approved chapters is approved by EASA. All other content is approved by DAI under the authority of EASA DOA No. EASA.21J.052 in accordance with Part 21.

0.2 RECORD OF REVISIONS

All revisions of this manual, with the exception of -

- Temporary Revisions,
- updates of the modification level (Section 1.1),
- updated mass and balance information (Section 6.3),
- updates of the Equipment Inventory (Section 6.5), and
- updates of the List of Supplements (Section 9.2)

must be recorded in the following table.

The new or amended text is indicated by a vertical black line at the left hand side of the revised page, with the revision number and date appearing at the bottom of the page.

If pages are revised which contain information valid for your particular serial number (modification level of the airplane, weighing data, Equipment Inventory, List of Supplements), then this information must be transferred to the new pages in hand-writing.

The cover pages of Temporary Revisions, if applicable, are inserted behind the cover page of this manual; the following pages of the Temporary Revision are inserted in front of the corresponding pages of this AFM. Temporary Revisions are used to provide information on systems or equipment until the next 'permanent' Revision of the Airplane Flight Manual. When a 'permanent' Revision covers a Mandatory or Optional Design Change Advisory (MÄM or OÄM), then the corresponding Temporary Revision is superseded. Example: Revision 3 covers OÄM 42-053, therefore the Temporary Revision TR-OÄM-42-053 is superseded by the 'permanent' Revision 3.

Page 0 - 2	Rev. 5	15-Nov-2007	Doc. No. 7.01.05-E
------------	--------	-------------	--------------------

Rev. No.	Reason	Chapter	Page(s)	Date of Revision	Approval	Verification	Date Inserted	Signature
1	IFR certification; corrections	all	all except cover page	1 Dec 2004	2005-196	[Ing. Andreas Winkler for ACG]		
2	MÄM 42-034 (elevator stop); OÄM 42-060 (T&B coordinat.); Take-off diagrams	0 4A 4B 5 6 7	0-3, 0-5, 0-7, 0-8, 0-9 4A-9 4B-25 5-11, 5-12 6-18 7-7	28 Jan 2005		[10 Feb 2005 Dipl.-Ing. (FH) Manfred Reichel for DAI]		
3	FAA Certification MÄM 42-062, -070/a, -079, -080, -091, -101, -111/b (TR-MÄM-42-111/a), -115 OÄM 42-053, -056, -057, -059, -079 Corrections	all	all	15 Oct 2005		[25 Oct 2005 Ing. Andreas Winkler for ACG]		

Rev. No.	Reason	Chapter	Page(s)	Date of Revision	Approval	Verification	Date Inserted	Signature
4	MÄM 42-037, -046, -063, -088, OÄM 42-054, -077, -080 corrections	0	0-3 thru 0-10	30 Nov 2005	EASA A.C. Ø2618	[20 Dec 2005 Ing. Andreas Winkler for ACG]		
		1	1-2, 1-11					
		2	2-2, 2-4, 2-7, 2-8, 2-10, 2-14, 2-15, 2-18, 2-21 thru 2-23, 2-26, 2-27, 2-32					
		3	3-30, 3-31, 3-32, 3-38					
		4A	all (4A-1 thru 4A-40)					
		4B	4B-2, 4B-13, 4B-25, 4B-27, 4B-30 thru 4B-34					
		5	all (5-1 thru 5-34)					
		6	6-5, 6-8, 6-10 thru 6-14, 6-16, 6-20					
		7	7-1, 7-2, 7-40 thru 7-66					
		8	8-4, 8-12					
9	9-2							

Rev. No.	Reason	Chapter	Page(s)	Date of Revision	Approval	Verification	Date Inserted	Signature
5	<p>MÄM 42- -174/a, -186, -198/b, -206, -240, -254, -258/a,</p> <p>OÄM 42- -055/a, -056/d -062, -065, -066, -067, -070, -074, -082, -092, -094, -095, -099, -101, -105, -112, -116, -121, -129,</p> <p>corrections</p>	all	all except cover page	15 Nov 2007		 <p>16. SEP. 2008</p> <p>Diamond Aircraft EASA 21J057 Doc 06</p>		

0.3 LIST OF EFFECTIVE PAGES

Ch.	Page	Date	Ch.	Page	Date
0	0-0	15-Oct-2005	2	2-1	15-Nov-2007
	0-0a	15-Nov-2007		2-2	15-Nov-2007
	0-1	15-Nov-2007		appr. 2-3	15-Nov-2007
	0-2	15-Nov-2007		appr. 2-4	15-Nov-2007
	0-3	15-Nov-2007		appr. 2-5	15-Nov-2007
	0-4	15-Nov-2007		appr. 2-6	15-Nov-2007
	0-5	15-Nov-2007		appr. 2-7	15-Nov-2007
	0-6	15-Nov-2007		appr. 2-8	15-Nov-2007
	0-7	15-Nov-2007		appr. 2-9	15-Nov-2007
	0-8	15-Nov-2007		appr. 2-10	15-Nov-2007
	0-9	15-Nov-2007		appr. 2-11	15-Nov-2007
	0-10	15-Nov-2007		appr. 2-12	15-Nov-2007
	0-11	15-Nov-2007		appr. 2-13	15-Nov-2007
0-12	15-Nov-2007	appr. 2-14		15-Nov-2007	
1	1-1	15-Nov-2007		appr. 2-15	15-Nov-2007
	1-2	15-Nov-2007		appr. 2-16	15-Nov-2007
	1-3	15-Nov-2007		appr. 2-17	15-Nov-2007
	1-4	15-Nov-2007		appr. 2-18	15-Nov-2007
	1-5	15-Nov-2007		appr. 2-19	15-Nov-2007
	1-6	15-Nov-2007		appr. 2-20	15-Nov-2007
	1-7	15-Nov-2007		appr. 2-21	15-Nov-2007
	1-8	15-Nov-2007		appr. 2-22	15-Nov-2007
	1-9	15-Nov-2007		appr. 2-23	15-Nov-2007
	1-10	15-Nov-2007		appr. 2-24	15-Nov-2007
	1-11	15-Nov-2007		appr. 2-25	15-Nov-2007
	1-12	15-Nov-2007		appr. 2-26	15-Nov-2007
	1-13	15-Nov-2007		appr. 2-27	15-Nov-2007
	1-14	15-Nov-2007		appr. 2-28	15-Nov-2007
	1-15	15-Nov-2007		appr. 2-29	15-Nov-2007
	1-16	15-Nov-2007		appr. 2-30	15-Nov-2007
	1-17	15-Nov-2007		appr. 2-31	15-Nov-2007
	1-18	15-Nov-2007		appr. 2-32	15-Nov-2007
	1-19	15-Nov-2007		appr. 2-33	15-Nov-2007
	1-20	15-Nov-2007		appr. 2-34	15-Nov-2007
1-21	15-Nov-2007				
1-22	15-Nov-2007				

Ch.	Page	Date
3	3-1	15-Nov-2007
	3-2	15-Nov-2007
	3-3	15-Nov-2007
	3-4	15-Nov-2007
	3-5	15-Nov-2007
	3-6	15-Nov-2007
	3-7	15-Nov-2007
	3-8	15-Nov-2007
	3-9	15-Nov-2007
	3-10	15-Nov-2007
	3-11	15-Nov-2007
	3-12	15-Nov-2007
	3-13	15-Nov-2007
	3-14	15-Nov-2007
	3-15	15-Nov-2007
	3-16	15-Nov-2007
	3-17	15-Nov-2007
	3-18	15-Nov-2007
	3-19	15-Nov-2007
	3-20	15-Nov-2007
	3-21	15-Nov-2007
	3-22	15-Nov-2007
	3-23	15-Nov-2007
	3-24	15-Nov-2007
	3-25	15-Nov-2007
	3-26	15-Nov-2007
	3-27	15-Nov-2007
	3-28	15-Nov-2007
	3-29	15-Nov-2007
	3-30	15-Nov-2007
	3-31	15-Nov-2007
	3-32	15-Nov-2007
	3-33	15-Nov-2007
	3-34	15-Nov-2007
	3-35	15-Nov-2007
	3-36	15-Nov-2007
	3-37	15-Nov-2007
	3-38	15-Nov-2007
	3-39	15-Nov-2007

Ch.	Page	Date
3	3-40	15-Nov-2007
	3-41	15-Nov-2007
	3-42	15-Nov-2007
	3-43	15-Nov-2007
	3-44	15-Nov-2007
	3-45	15-Nov-2007
	3-46	15-Nov-2007
	3-47	15-Nov-2007
	3-48	15-Nov-2007
	3-49	15-Nov-2007
	3-50	15-Nov-2007
	3-51	15-Nov-2007
	3-52	15-Nov-2007
	3-53	15-Nov-2007
	3-54	15-Nov-2007
	3-55	15-Nov-2007
	3-56	15-Nov-2007
	3-57	15-Nov-2007
	3-58	15-Nov-2007
	3-59	15-Nov-2007
	3-60	15-Nov-2007
	3-61	15-Nov-2007
	3-62	15-Nov-2007

Ch.	Page	Date
4A	4A-1	15-Nov-2007
	4A-2	15-Nov-2007
	4A-3	15-Nov-2007
	4A-4	15-Nov-2007
	4A-5	15-Nov-2007
	4A-6	15-Nov-2007
	4A-7	15-Nov-2007
	4A-8	15-Nov-2007
	4A-9	15-Nov-2007
	4A-10	15-Nov-2007
	4A-11	15-Nov-2007
	4A-12	15-Nov-2007
	4A-13	15-Nov-2007
	4A-14	15-Nov-2007
	4A-15	15-Nov-2007
	4A-16	15-Nov-2007
	4A-17	15-Nov-2007
	4A-18	15-Nov-2007
	4A-19	15-Nov-2007
	4A-20	15-Nov-2007
	4A-21	15-Nov-2007
	4A-22	15-Nov-2007
	4A-23	15-Nov-2007
	4A-24	15-Nov-2007
	4A-25	15-Nov-2007
	4A-26	15-Nov-2007
	4A-27	15-Nov-2007
	4A-28	15-Nov-2007
	4A-29	15-Nov-2007
	4A-30	15-Nov-2007
	4A-31	15-Nov-2007
	4A-32	15-Nov-2007
	4A-33	15-Nov-2007
	4A-34	15-Nov-2007
	4A-35	15-Nov-2007
	4A-36	15-Nov-2007
	4A-37	15-Nov-2007
	4A-38	15-Nov-2007
	4A-39	15-Nov-2007
	4A-40	15-Nov-2007
	4A-41	15-Nov-2007
	4A-42	15-Nov-2007

Ch.	Page	Date
4B	4B-1	15-Nov-2007
	4B-2	15-Nov-2007
	4B-3	15-Nov-2007
	4B-4	15-Nov-2007
	4B-5	15-Nov-2007
	4B-6	15-Nov-2007
	4B-7	15-Nov-2007
	4B-8	15-Nov-2007
	4B-9	15-Nov-2007
	4B-10	15-Nov-2007
	4B-11	15-Nov-2007
	4B-12	15-Nov-2007
	4B-13	15-Nov-2007
	4B-14	15-Nov-2007
	4B-15	15-Nov-2007
	4B-16	15-Nov-2007
	4B-17	15-Nov-2007
	4B-18	15-Nov-2007
	4B-19	15-Nov-2007
	4B-20	15-Nov-2007
	4B-21	15-Nov-2007
	4B-22	15-Nov-2007
	4B-23	15-Nov-2007
	4B-24	15-Nov-2007
	4B-25	15-Nov-2007
	4B-26	15-Nov-2007
	4B-27	15-Nov-2007
	4B-28	15-Nov-2007
	4B-29	15-Nov-2007
	4B-30	15-Nov-2007
	4B-31	15-Nov-2007
	4B-32	15-Nov-2007

Ch.	Page	Date
5	5-1	15-Nov-2007
	5-2	15-Nov-2007
	5-3	15-Nov-2007
	5-4	15-Nov-2007
	5-5	15-Nov-2007
	5-6	15-Nov-2007
	5-7	15-Nov-2007
	5-8	15-Nov-2007
	5-9	15-Nov-2007
	5-10	15-Nov-2007
	5-11	15-Nov-2007
	5-12	15-Nov-2007
	5-13	15-Nov-2007
	5-14	15-Nov-2007
	5-15	15-Nov-2007
	5-16	15-Nov-2007
	5-17	15-Nov-2007
	5-18	15-Nov-2007
	5-19	15-Nov-2007
	5-20	15-Nov-2007
	5-21	15-Nov-2007
	5-22	15-Nov-2007
	5-23	15-Nov-2007
	5-24	15-Nov-2007
	5-25	15-Nov-2007
	5-26	15-Nov-2007
	5-27	15-Nov-2007
	5-28	15-Nov-2007
	5-29	15-Nov-2007
	5-30	15-Nov-2007
	5-31	15-Nov-2007
	5-32	15-Nov-2007
	5-33	15-Nov-2007
	5-34	15-Nov-2007
	5-35	15-Nov-2007
	5-36	15-Nov-2007

Ch.	Page	Date
6	6-1	15-Nov-2007
	6-2	15-Nov-2007
	6-3	15-Nov-2007
	6-4	15-Nov-2007
	6-5	15-Nov-2007
	6-6	15-Nov-2007
	6-7	15-Nov-2007
	6-8	15-Nov-2007
	6-9	15-Nov-2007
	6-10	15-Nov-2007
	6-11	15-Nov-2007
	6-12	15-Nov-2007
	6-13	15-Nov-2007
	6-14	15-Nov-2007
	6-15	15-Nov-2007
	6-16	15-Nov-2007
	6-17	15-Nov-2007
	6-18	15-Nov-2007
	6-19	15-Nov-2007
	6-20	15-Nov-2007
	6-21	15-Nov-2007
	6-22	15-Nov-2007
	6-23	15-Nov-2007
	6-24	15-Nov-2007
	6-25	15-Nov-2007
	6-26	15-Nov-2007
	6-27	15-Nov-2007
	6-28	15-Nov-2007

Ch.	Page	Date
7	7-1	15-Nov-2007
	7-2	15-Nov-2007
	7-3	15-Nov-2007
	7-4	15-Nov-2007
	7-5	15-Nov-2007
	7-6	15-Nov-2007
	7-7	15-Nov-2007
	7-8	15-Nov-2007
	7-9	15-Nov-2007
	7-10	15-Nov-2007
	7-11	15-Nov-2007
	7-12	15-Nov-2007
	7-13	15-Nov-2007
	7-14	15-Nov-2007
	7-15	15-Nov-2007
	7-16	15-Nov-2007
	7-17	15-Nov-2007
	7-18	15-Nov-2007
	7-19	15-Nov-2007
	7-20	15-Nov-2007
	7-21	15-Nov-2007
	7-22	15-Nov-2007
	7-23	15-Nov-2007
	7-24	15-Nov-2007
	7-25	15-Nov-2007
	7-26	15-Nov-2007
	7-27	15-Nov-2007
	7-28	15-Nov-2007
	7-29	15-Nov-2007
	7-30	15-Nov-2007
	7-31	15-Nov-2007
	7-32	15-Nov-2007
	7-33	15-Nov-2007
	7-34	15-Nov-2007
	7-35	15-Nov-2007
	7-36	15-Nov-2007
	7-37	15-Nov-2007
	7-38	15-Nov-2007
	7-39	15-Nov-2007

Ch.	Page	Date
7	7-40	15-Nov-2007
	7-41	15-Nov-2007
	7-42	15-Nov-2007
	7-43	15-Nov-2007
	7-44	15-Nov-2007
	7-45	15-Nov-2007
	7-46	15-Nov-2007
	7-47	15-Nov-2007
	7-48	15-Nov-2007
	7-49	15-Nov-2007
	7-50	15-Nov-2007
	7-51	15-Nov-2007
	7-52	15-Nov-2007
	7-53	15-Nov-2007
	7-54	15-Nov-2007
	7-55	15-Nov-2007
	7-56	15-Nov-2007
	7-57	15-Nov-2007
	7-58	15-Nov-2007
	7-59	15-Nov-2007
	7-60	15-Nov-2007
	7-61	15-Nov-2007
	7-62	15-Nov-2007
	7-63	15-Nov-2007
	7-64	15-Nov-2007
	7-65	15-Nov-2007
	7-66	15-Nov-2007
	7-67	15-Nov-2007
	7-68	15-Nov-2007
	7-69	15-Nov-2007
7-70	15-Nov-2007	

Ch.	Page	Date
8	8-1	15-Nov-2007
	8-2	15-Nov-2007
	8-3	15-Nov-2007
	8-4	15-Nov-2007
	8-5	15-Nov-2007
	8-6	15-Nov-2007
	8-7	15-Nov-2007
	8-8	15-Nov-2007
	8-9	15-Nov-2007
	8-10	15-Nov-2007
	8-11	15-Nov-2007
	8-12	15-Nov-2007
9	9-1	15-Nov-2007
	9-2	15-Nov-2007

Intentionally left blank.

CHAPTER 1

GENERAL

	Page
1.1 INTRODUCTION	1-2
1.2 CERTIFICATION BASIS	1-4
1.3 WARNINGS, CAUTIONS AND NOTES	1-4
1.4 DIMENSIONS	1-5
1.5 DEFINITIONS AND ABBREVIATIONS	1-7
1.6 UNITS OF MEASUREMENT	1-15
1.6.1 CONVERSION FACTORS	1-15
1.6.2 CONVERSION CHART LITERS / US GALLONS	1-17
1.7 THREE-VIEW DRAWING	1-18
1.8 G1000 AVIONICS SYSTEM	1-19
1.9 SOURCE DOCUMENTATION	1-21
1.9.1 ENGINE	1-21
1.9.2 PROPELLER	1-22
1.9.3 AVIONICS SYSTEM	1-22

1.1 INTRODUCTION

This Airplane Flight Manual has been prepared in order to provide pilots and instructors with all the information required for the safe and efficient operation of the airplane.

The Airplane Flight Manual includes all the data which must be made available to the pilot according to the JAR-23 requirement. Beyond this, it contains further data and operating instructions which, in the manufacturer's opinion, could be of value to the pilot.

- This Airplane Flight Manual is valid for all serial numbers with a KAP 140 or no autopilot system installed. Equipment and modification level (design details) of the airplane may vary from serial number to serial number. Therefore, some of the information contained in this manual is applicable depending on the respective equipment and modification level. The exact equipment of your serial number is recorded in the Equipment Inventory in Section 6.5. The modification level is recorded in the following table (as far as necessary for this manual).

Modification	Source	Installed	
Use of Diesel Fuel	MÄM 42-037	<input type="checkbox"/> yes	<input type="checkbox"/> no
Increased Take-Off Mass	MÄM 42-088	<input type="checkbox"/> yes	<input type="checkbox"/> no
New Engine Instrument Markings	MÄM 42-101	<input type="checkbox"/> yes	<input type="checkbox"/> no
Autopilot Static Source	MÄM 42-186	<input type="checkbox"/> yes	<input type="checkbox"/> no
TAE 125-02-99 Engine	MÄM 42-198	<input type="checkbox"/> yes	<input type="checkbox"/> no
ECU Backup Battery	MÄM 42-240	<input type="checkbox"/> yes	<input type="checkbox"/> no
Ice Protection System	OÄM 42-053	<input type="checkbox"/> yes	<input type="checkbox"/> no
Ice Protection System (Known Icing)	OÄM 42-054	<input type="checkbox"/> yes	<input type="checkbox"/> no

Modification	Source	Installed	
Oxygen System	OÄM 42-055	<input type="checkbox"/> yes	<input type="checkbox"/> no
Auxiliary Fuel Tanks	OÄM 42-056	<input type="checkbox"/> yes	<input type="checkbox"/> no
Front Seats with Adjustable Backrest	OÄM 42-067	<input type="checkbox"/> yes	<input type="checkbox"/> no
Electrical Rudder Pedal Adjustment	OÄM 42-070	<input type="checkbox"/> yes	<input type="checkbox"/> no
Mission Power Supply System	OÄM 42-074	<input type="checkbox"/> yes	<input type="checkbox"/> no
Removable Fuselage Nose Cone	OÄM 42-077	<input type="checkbox"/> yes	<input type="checkbox"/> no
ECU Backup Battery	OÄM 42-129	<input type="checkbox"/> yes	<input type="checkbox"/> no

This Airplane Flight Manual must be kept on board the airplane at all times. Its designated place is the side bag of the forward left seat. The designated place for the Garmin G1000 Cockpit Reference Guide is the bag on the rear side of the forward left seat.

CAUTION

The DA 42 is a twin engine airplane. When the operating limitations and maintenance requirements are complied with, it has the high degree of reliability which is required by the certification basis. Nevertheless, an engine failure is not completely impossible. For this reason it is highly recommended for flights during the night, on top, under IMC, or above terrain which is unsuitable for a landing, to select flight times and flight routes such that reduced performance in case of single engine operation does not constitute a risk.

1.2 CERTIFICATION BASIS

The certification basis is JAR-23, published on 11-Mar-1994, including Amdt. 1, and additional requirements as laid down in CRI A-01.

1.3 WARNINGS, CAUTIONS AND NOTES

Special statements in the Airplane Flight Manual concerning the safety or operation of the airplane are highlighted by being prefixed by one of the following terms:

WARNING

means that the non-observation of the corresponding procedure leads to an immediate or important degradation in flight safety.

CAUTION

means that the non-observation of the corresponding procedure leads to a minor or to a more or less long term degradation in flight safety.

NOTE

draws the attention to any special item not directly related to safety but which is important or unusual.

1.4 DIMENSIONS

NOTE

All dimensions shown below are approximate.

Overall dimensions

Span	: 13.42 m	44 ft
	13.55 m	44.5 ft including ACL
Length	: 8.56 m	28 ft 1 in
Height	: 2.49 m	8 ft 2 in

Wing

Airfoil	: Wortmann FX 63-137/20 - W4	
Wing Area	: 16.29 m ²	175.3 sq.ft.
Mean aerodynamic chord	: 1.271 m	4 ft 2 in
Aspect ratio	: 11.06	
Dihedral	: 5°	
Leading edge sweep	: 1°	

Aileron

Area (total, left + right)	: 0.66 m ²	7.1 sq.ft.
----------------------------	-----------------------	------------

Wing flaps

Area (total, left + right) : 2.18 m² 23.4 sq.ft.

Horizontal tail

Area : 2.35 m² 25.3 sq.ft.

Elevator area : 0.66 m² 7.1 sq.ft.

Angle of incidence : -1.1° relative to longitudinal axis of airplane

Vertical tail

Area : 2.43 m² 26.2 sq.ft.

Rudder area : 0.78 m² 8.4 sq.ft.

Landing gear

Track : 2.95 m 9 ft 8 in

Wheelbase : 1.735 m 5 ft 8 in

Nose wheel : 5.00-5; 10 PR, 120 mph

Main wheel : 15x6.0-6; 6 PR, 120 mph

1.5 DEFINITIONS AND ABBREVIATIONS

(a) Airspeeds

CAS: Calibrated Airspeed. Indicated airspeed, corrected for installation and instrument errors. CAS equals TAS at standard atmospheric conditions (ISA) at MSL.

IAS: Indicated Airspeed as shown on an airspeed indicator.

■ KCAS: CAS in knots.

■ KIAS: IAS in knots.

TAS: True Airspeed. The speed of the airplane relative to the air. TAS is CAS corrected for errors due to altitude and temperature.

V_A : Maneuvering Speed. Full or abrupt control surface movement is not permissible above this speed.

V_{FE} : Maximum Flaps Extended Speed. This speed must not be exceeded with the given flap setting.

V_{LO} : Maximum Landing Gear Operating Speed. This speed may not be exceeded during the extension or retraction of the landing gear.

V_{LE} : Maximum Landing Gear Extended Speed. This speed may not be exceeded if the landing gear is extended.

V_{mCA} : Minimum Control Speed. Minimum speed necessary to be able to control the airplane in case of one engine inoperative.

V_{NE} : Never Exceed Speed in smooth air. This speed must not be exceeded in any operation.

- V_{NO} : Maximum Structural Cruising Speed. This speed may be exceeded only in smooth air, and then only with caution.
- V_S : Stalling Speed, or the minimum continuous speed at which the airplane is still controllable in the given configuration.
- V_{S0} : Stalling Speed, or the minimum continuous speed at which the airplane is still controllable in the landing configuration.
- V_{S1} : Stalling Speed, or the minimum continuous speed at which the airplane is still controllable with flaps and landing gear retracted.
- V_{SSE} : Minimum Control Speed for Schooling. Minimum speed necessary in case of one engine intentionally inoperative / idle (training purposes).
- V_x : Best Angle-of-Climb Speed.
- V_y : Best Rate-of-Climb Speed.
- V_{YSE} : Best Rate of-Climb Speed for one engine inoperative.

(b) Meteorological terms

- ISA: International Standard Atmosphere. Conditions at which air is identified as an ideal dry gas. The temperature at mean sea level is 15 °C (59 °F), air pressure at MSL is 1,013.25 hPa (29.92 inHg); the temperature gradient up to the altitude at which the temperature reaches -56.5 °C (-69.7 °F) is -0.0065 °C/m (-0.00357 °F/ft), and above this 0 °C/m (0 °F/ft).
- MSL: Mean Sea Level.
- OAT: Outside Air Temperature.

QNH: Theoretical atmospheric pressure at MSL, calculated from the elevation of the measuring point above MSL and the actual atmospheric pressure at the measuring point.

Density Altitude:

Altitude in ISA conditions at which the air density is equal to the current air density.

Indicated Pressure Altitude:

Altitude reading with altimeter set to 1,013.25 hPa (29.92 inHg).

Pressure Altitude:

Altitude indicated by a barometric altimeter, which is set to 1,013.25 hPa (29.92 inHg). The Pressure Altitude is the Indicated Pressure Altitude corrected for installation and instrument errors.

In this Airplane Flight Manual altimeter instrument errors are regarded as zero.

Wind:

The wind speeds which are shown as variables in the diagrams in this manual should be regarded as headwind or tailwind components of the measured wind.

(c) Flight performance and flight planning

AGL: Above Ground Level.

Demonstrated Crosswind Component:

The speed of the crosswind component at which adequate maneuverability for take-off and landing has been demonstrated during type certification.

MET: Weather, weather advice.

NAV: Navigation, route planning.

RoC: Rate of Climb.

(d) Mass and balance

CG: Center of Gravity, also called 'center of mass'. Imaginary point in which the airplane mass is assumed to be concentrated for mass and balance calculations. Its distance from the Datum Plane is equal to the Center of Gravity Moment Arm.

Center of Gravity Moment Arm:

The Moment Arm which is obtained if one divides the sum of the individual moments of the airplane by its total mass.

Center of Gravity Limits:

The Center of Gravity range within which the airplane, at a given mass, must be operated.

DP: Datum Plane; an imaginary vertical plane from which all horizontal distances for center of gravity calculations are measured.

█ Empty Mass: The mass of the airplane including unusable fuel, all operating fluids and the maximum quantity of oil.

Maximum Take-off Mass:

The maximum permissible mass for take-off.

Maximum Landing Mass:

The highest mass for landing conditions at the maximum descent velocity. This velocity was used in the strength calculations to determine the landing gear loads during a particularly hard landing.

Moment Arm: The horizontal distance from the Datum Plane to the Center of Gravity of a component.

Moment: The mass of a component multiplied by its moment arm.

Usable Fuel: The quantity of fuel available for flight planning.

Unusable Fuel: The quantity of fuel remaining in the tank which cannot be used for flight.

Useful Load: The difference between take-off mass and empty mass.

(e) Engine

ECU: Engine Control Unit.

FADEC: Full Authority Digital Engine Control.

RPM: Revolutions per minute (rotational speed of the propeller).

Engine starting fuel temperature:

Above this fuel temperature the engine may be started.

Take-off fuel temperature:

Above this fuel temperature take-off power setting is permitted.

(f) Designation of the circuit breakers on the instrument panel*LH MAIN BUS:*

COM1	COM Radio No. 1
GPS/NAV1	Global Positioning System and NAV Receiver No. 1
XPDR	Transponder
ENG INST	Engine Instruments
PITOT	Pitot Heating System
XFR PUMP/DE-ICE	Fuel Transfer Pump / De-Icing System
TAXI/MAP/ACL	Taxi-, Map-, Anti Collision Light
FLOOD/OXY	Flood Light / Oxygen System
PFD	Primary Flight Display
ADC	Air Data Computer
AHRS	Attitude Heading Reference System
GEAR WRN/ELEV. LIMIT	Landing Gear Annunciation / Variable Elevator Stop
GEAR	Landing Gear Control

RH MAIN BUS:

MFD	Multi Function Display
AH	Artificial Horizon
STALL WRN	Stall Warning System
FLAP	Flap System
LDG LT/START	Landing Light / Start
INST LT/ NAV LT	Instrument-, Navigation (Position) Light
AV/CDU/FAN	Avionic-, CDU-Cooling Fans
AVIONIC BUS	Avionic Bus
AV CONT.	Avionic Control

AVIONICS BUS:

COM2	COM Radio No. 2
GPS/NAV2	Global Positioning System and NAV Receiver No. 2
AUDIO	Audio Panel
AUTO PILOT	Auto Pilot System
Wx 500	Stormscope
ADF	Automatic Direction Finder
DME	Distance Measuring Equipment
Wx RDR	Weather Radar
TAS	Traffic Advisory System
DATA LINK	GDL 69A Data Link System

LH ENG ECU BUS:

ECU BUS	LH ECU Bus
ECU B	LH ECU B
ECU A	LH ECU A

LH BUS:

ALT.LH	LH Alternator
BATT	Battery

RH BUS:

ALT.RH	RH Alternator
BATT	Battery

RH ENG ECU BUS:

ECU BUS	RH ECU Bus
ECU B	RH ECU B
ECU A	RH ECU A

(g) Equipment

ELT: Emergency Locator Transmitter.

(h) Design Change Advisories

MÄM: Mandatory Design Change Advisory.

OÄM: Optional Design Change Advisory.

(i) Miscellaneous

ACG: Austro Control GmbH (formerly BAZ, Federal Office of Civil Aviation).

ATC: Air Traffic Control.

CFRP: Carbon Fiber Reinforced Plastic.

EASA: European Aviation Safety Agency.

EPU: External Power Unit.

GIA: Garmin Integrated Avionics.

GFRP: Glass Fiber Reinforced Plastic.

JAR: Joint Aviation Requirements.

JC/VP: Joint Certification/Validation Procedure.

PCA: Primary Certification Authority.

1.6 UNITS OF MEASUREMENT

1.6.1 CONVERSION FACTORS

Dimension	SI-Units	US Units	Conversion
Length	[mm] millimeters	[in] inches	$[mm] / 25.4 = [in]$
	[m] meters	[ft] feet	$[m] / 0.3048 = [ft]$
	[km] kilometers	[NM] nautical miles	$[km] / 1.852 = [NM]$
Volume	[l] liters	[US gal] US gallons	$[l] / 3.7854 = [US\ gal]$
		[qts] US quarts	$[l] / 0.9464 = [qts]$
Speed	[km/h] kilometers per hour	[kts] knots	$[km/h] / 1.852 = [kts]$
	[m/s] meters per second	[mph] miles per hour	$[km/h] / 1.609 = [mph]$
		[fpm] feet per minute	$[m/s] \times 196.85 = [fpm]$
Speed of rotation	[RPM] revolutions per minute		--
Mass	[kg] kilograms	[lb] pounds	$[kg] \times 2.2046 = [lb]$
Force, weight	[N] newtons	[lbf] pounds force	$[N] \times 0.2248 = [lbf]$
Pressure	[hPa] hecto-pascals	[inHg] inches of mercury	$[hPa] = [mbar]$
	[mbar] millibars	[psi] pounds per square inch	$[hPa] / 33.86 = [inHg]$
	[bar] bars		$[bar] \times 14.504 = [psi]$
Temperature	[°C] degrees Celsius	[°F] degrees Fahrenheit	$[°C] \times 1.8 + 32 = [°F]$ $([°F] - 32) / 1.8 = [°C]$

Dimension	SI-Units	US Units	Conversion
Intensity of electric current	[A] ampères		--
Electric charge (battery capacity)	[Ah] ampère-hours		--
Electric potential	[V] volts		--
Time	[sec] seconds		--

1.6.2 CONVERSION CHART LITERS / US GALLONS

Liters	US Gallons
5	1.3
10	2.6
15	4.0
20	5.3
25	6.6
30	7.9
35	9.2
40	10.6
45	11.9
50	13.2
60	15.9
70	18.5
80	21.1
90	23.8
100	26.4
110	29.1
120	31.7
130	34.3
140	37.0
150	39.6
160	42.3
170	44.9
180	47.6

US Gallons	Liters
1	3.8
2	7.6
4	15.1
6	22.7
8	30.3
10	37.9
12	45.4
14	53.0
16	60.6
18	68.1
20	75.7
22	83.3
24	90.9
26	98.4
28	106.0
30	113.6
32	121.1
34	128.7
36	136.3
38	143.8
40	151.4
45	170.3
50	189.3

1.7 THREE-VIEW DRAWING

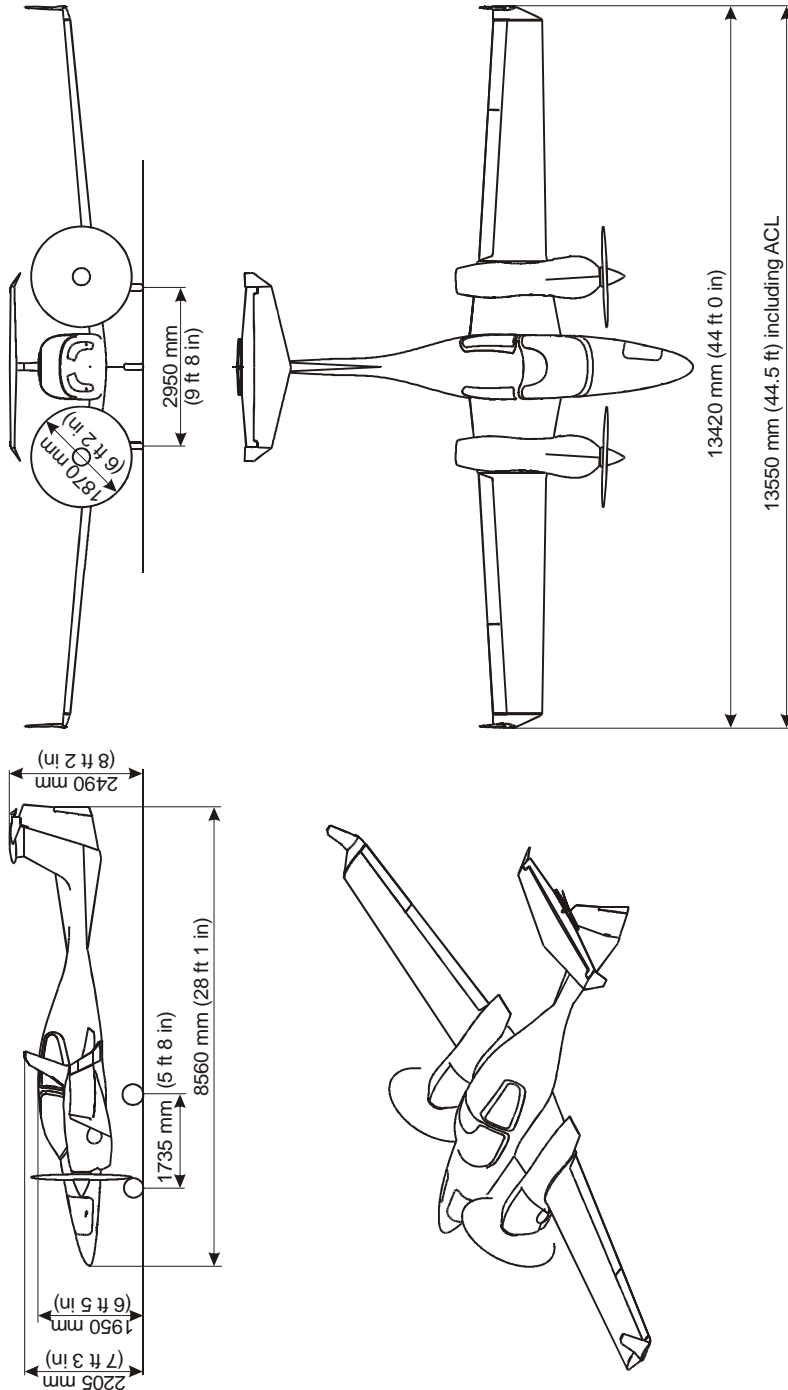

1.8 G1000 AVIONICS SYSTEM

1. The G1000 Integrated Avionics System is a fully integrated flight, engine, communication, navigation and surveillance instrumentation system. The system consists of a Primary Flight Display (PFD), Multi-Function Display (MFD), audio panel, Air Data Computer (ADC), Attitude and Heading Reference System (AHRS), engine sensors and processing unit (GEA), and integrated avionics (GIA) containing VHF communications, VHF navigation, and GPS (Global Positioning System).
2. The primary function of the PFD is to provide attitude, heading, air data, navigation, and alerting information to the pilot. The PFD may also be used for flight planning. The primary function of the MFD is to provide engine information, mapping, terrain information, and for flight planning. The audio panel is used for selection of radios for transmitting and listening, intercom functions, and marker beacon functions.
3. The primary function of the VHF Communication portion of the G1000 is to enable external radio communication. The primary function of the VOR/ILS Receiver portion of the equipment is to receive and demodulate VOR, Localizer, and Glide Slope signals. The primary function of the GPS portion of the system is to acquire signals from the GPS satellites, recover orbital data, make range and Doppler measurements, and process this information in real-time to obtain the user's position, velocity, and time.
4. Provided a Garmin G1000 GPS receiver is receiving adequate usable signals, it has been demonstrated capable of and has been shown to meet the accuracy specifications for:
 - (a) VFR/IFR enroute, oceanic, terminal, and non-precision instrument approach (GPS, Loran-C, VOR, VOR-DME, TACAN, NDB, NDB-DME, RNAV) operation within the U.S. National Airspace System in accordance with AC 20-138A.

(b) RNAV (GPS) Approaches - The G1000 GPS meets the requirements of AC 20-138(A) for GPS based RNAV approaches. This includes RNAV approaches labeled as RNAV (GPS), provided GPS sensor data is valid.

(c) The system meets the accuracy of RNP5 airspace (BRNAV) requirements of AC 90-96 and in accordance with AC 20-138A, EASA AMC 20-4, and FAA Order 8110.60 for oceanic and remote airspace operations, provided it is receiving usable navigation information from the GPS receiver.

Navigation is accomplished using the WGS-84 (NAD-83) coordinate reference datum. GPS navigation data is based upon use of only the GPS operated by the United States of America.

1.9 SOURCE DOCUMENTATION

This section lists documents, manuals and other literature that were used as sources for the Airplane Flight Manual, and indicates the respective publisher. However, only the information given in the Airplane Flight Manual is valid.

1.9.1 ENGINE

Address: Thielert Aircraft Engines GmbH
Platanenstrasse 14
D-09350 Lichtenstein
GERMANY

Phone: +49-(37204)-696-90

Fax: +49-(37204)-696-50

Website: www.thielert.com

Documents: TAE 125-01 Operation and Maintenance Manual

| or

| TAE 125-02-99 Operation and Maintenance Manual
| (if MÄM 42-198 carried out)

1.9.2 PROPELLER

Address: mt-propeller
Airport Straubing Wallmühle
D-94348 Atting
GERMANY

Phone: +49-(9429)-9409-0
E-mail: sales@mt-propeller.com
Website: www.mt-propeller.de

Documents: E-124, Operation and Installation Manual
Hydraulically controlled variable pitch propeller
MTV -5, -6, -9, -11, -12, -14, -15, -16, -21, -22, -25

1.9.3 AVIONICS SYSTEM

Address: Garmin International, Inc.
1200 East 151st Street
Olathe, Kansas 66062
USA

Phone: +1-(913)-3978200
Fax: +1-(913)-3978282
Website: www.garmin.com

Documents: G1000 Cockpit Reference Guide
P/N 190-00406-00, Sept. 2004

CHAPTER 2

OPERATING LIMITATIONS

	Page
2.1 INTRODUCTION	2-3
2.2 AIRSPEED	2-4
2.3 AIRSPEED INDICATOR MARKINGS	2-5
2.4 POWER-PLANT LIMITATIONS	2-6
2.5 ENGINE INSTRUMENT MARKINGS	2-9
2.6 WARNING, CAUTION AND ADVISORY ALERTS	2-11
2.6.1 WARNING, CAUTION AND ADVISORY ALERTS ON THE G1000	2-11
2.6.2 OTHER WARNING ALERTS	2-14
2.7 MASS (WEIGHT)	2-15
2.8 CENTER OF GRAVITY	2-16
2.9 APPROVED MANEUVERS	2-17
2.10 MANEUVERING LOAD FACTORS	2-18
2.11 OPERATING ALTITUDE	2-19
2.12 FLIGHT CREW	2-19
2.13 KINDS OF OPERATION	2-19
2.14 FUEL	2-22
2.15 LIMITATION PLACARDS	2-24
2.16 OTHER LIMITATIONS	2-28
2.16.1 FUEL TEMPERATURE	2-28
2.16.2 BATTERY CHARGE	2-28
2.16.3 EMERGENCY SWITCH	2-29
2.16.4 DOOR LOCKING DEVICE	2-29

2.16.5 ELECTRONIC EQUIPMENT 2-29

2.16.6 GARMIN G1000 AVIONICS SYSTEM 2-30

2.16.7 SMOKING 2-34

2.16.8 GROUND OPERATION 2-34

2.16.9 USE OF THE SUN VISORS 2-34

2.1 INTRODUCTION

Chapter 2 of this Airplane Flight Manual provides operating limitations, instrument markings and placards necessary for the safe operation of the airplane, its powerplants, standard systems and standard equipment.

The limitations included in this Chapter are approved.

WARNING

Operation of the airplane outside of the approved operating limitations is not permissible.

2.2 AIRSPEED

	Airspeed		IAS	Remarks
V _A	Maneuvering speed	above 1542 kg (3400 lb)	126 KIAS	Do not make full or abrupt control surface movement above this speed.
		up to 1542 kg (3400 lb)	120 KIAS	
V _{FE}	Max. flaps extended speed	LDG	111 KIAS	Do not exceed these speeds with the given flap setting.
		APP	137 KIAS	
V _{LO}	Max. landing gear operating speed	Extension	V _{LOE} 194 KIAS	Do not operate the landing gear above this speed.
		Retraction	V _{LOR} 156 KIAS	
V _{LE}	Max. landing gear extended speed		194 KIAS	Do not exceed this speed with the landing gear extended.
V _{MCA}	Minimum control speed airborne		68 KIAS	With one engine inoperative keep airspeed above this limit.
V _{NO}	Max. structural cruising speed		155 KIAS	Do not exceed this speed except in smooth air, and then only with caution.
V _{NE}	Never exceed speed in smooth air		194 KIAS	Do not exceed this speed in any operation.

2.3 AIRSPEED INDICATOR MARKINGS

Marking	KIAS	Significance
White arc	56 - 111 KIAS	Operating range with flaps fully extended.
Green arc	62 - 155 KIAS	Normal operating range.
Yellow arc	155 - 194 KIAS	'Caution range' - "Only in smooth air".
Blue radial	82 KIAS	Best rate of climb speed, single engine.
Red radial	68 KIAS	Minimum control speed, single engine.
Red radial	194 KIAS	Maximum speed for all operations - V_{NE} .

2.4 POWER-PLANT LIMITATIONS

- a) Number of engines : 2
- b) Engine manufacturer : Thielert Aircraft Engines
- c) Engine designation : TAE 125-01 Centurion 1.7
 or
 TAE 125-02-99 (if MÄM 42-198 is carried out)
 (P/N see Equipment List in Chapter 6)
- d) RPM limitations (shown as propeller RPM)
 - Maximum : 2300 RPM
 - Maximum overspeed : 2500 RPM (max. 20 sec)
- e) Engine power
 - Max. take-off power : 99 kW (135 DIN-hp) at 2300 RPM (100 % load)
 - Max. continuous power : 99 kW (135 DIN-hp) at 2300 RPM (100 % load)
- f) Fuel temperature:

	TAE 125-01	TAE 125-02-99 (MÄM 42-198 carried out)
Minimum	-30 °C	-30 °C
Maximum	+75 °C	+75 °C

- g) Oil pressure (indicated values are corrected for pressure altitude)
 - Minimum : 1.0 bar
 - Maximum : 6.5 bar
- h) Oil quantity (per engine)
 - Minimum : 4.5 liters (appr. 4.8 US qts)
 - Maximum : 6.0 liters (appr. 6.3 US qts)
 - Maximum oil consumption : 0.1 liters/hr (appr. 0.1 US qts/hr)

i) Oil temperature:

	TAE 125-01	TAE 125-02-99 (MÄM 42-198 carried out)
Minimum	-32 °C	-30 °C
Maximum	+140 °C	+140 °C

j) Gearbox temperature

Maximum : 120 °C

k) Coolant temperature:

	TAE 125-01	TAE 125-02-99 (MÄM 42-198 carried out)
Minimum	-32 °C	-30 °C
Maximum	+105 °C	+105 °C

l) Voltage

Minimum : 24.1 V

Maximum : 32.0 V

m) Amperage

Maximum : 60 A

n) Propeller manufacturer : mt-Propeller

o) Propeller designation : MTV-6-A-C-F/CF 187-129

p) Propeller diameter : 187 cm (6 ft 2 in)

q) Prop. pitch angle (@ 0.75 R) : 12° ±0.2° (low pitch)
15° ±1° (start lock position)
81° ±1° (feathered position)

- r) Approved fuel grades : see Section 2.14 - FUEL
- s) Oil specification : SHELL HELIX ULTRA 5W30 synthetic API SL/CF
SHELL HELIX ULTRA 5W40 synthetic API SL/CF
AERO SHELL OIL Diesel 10W-40
- t) Gearbox oil (propeller gearbox): SHELL EP 75W90 API GL-4
SHELL Spirax GSX 75W-80
- u) Coolant : Water / Cooler protection (BASF Glysantin Protect Plus/G48) 1/1. The freezing point of the coolant is -36 °C (-32.8 °F).

CAUTION

If the coolant or gearbox oil level is low, the reason must be determined and the problem must be corrected by authorized personnel.

- v) Maximum restart altitude : 6000 ft (TAE 125-01 engine installed)
8000 ft (TAE 125-02-99 engine installed)
- w) Restart airspeed : 80 to 120 KIAS

2.5 ENGINE INSTRUMENT MARKINGS

Engine instrument markings and their color code significance are shown in the tables below.

I If the TAE 125-01 engine is installed:

Indication	Red arc/bar = lower prohibited range	Yellow arc/bar = caution range	Green arc/bar = normal operating range	Yellow arc/bar = caution range	Red arc/bar = upper prohibited range
RPM	--	--	up to 2300 RPM		above 2300 RPM
Oil pressure	below 1.0 bar	1.0 to 2.3 bar	2.3 to 5.2 bar	5.2 to 6.5 bar	above 6.5 bar
Oil temp.	below -32 °C	-32 to 50 °C	50 to 125 °C ¹ 50 to 130 °C ²	125 to 140 °C ¹ 131 to 140 °C ²	above 140 °C
Coolant temp.	below -32 °C	-32 to 60 °C	60 to 96 °C ¹ 60 to 101 °C ²	96 to 105 °C ¹ 102 to 105 °C ²	above 105 °C
Gearbox temp.	--	--	up to 115 °C	115 to 120 °C	above 120 °C
Load	--	--	0 to 100 %	--	--
Fuel temp.	below -30 °C	-30 to -22 °C ¹ -30 to +4 °C ²	-22 to 70 °C ¹ +5 to 69 °C ²	70 to 75 °C	above 75 °C
Ammeter	--	--	up to 60 A	--	above 60 A
Volt-meter	below 24.1 V	24.1 to 25 V	25 to 30 V	30 to 32 V	above 32 V
Fuel qty.	0 US gal	--	0 to 25 US gal	--	--

¹⁾ MÄM 42-101 not implemented

²⁾ MÄM 42-101 implemented (refer to Section 1.1)

If the TAE 125-02-99 engine is installed (MÄM 42-198 carried out):

Indi- cation	Red arc/bar = lower prohibited range	Yellow arc/bar = caution range	Green arc/bar = normal operating range	Yellow arc/bar = caution range	Red arc/bar = upper prohibited range
RPM	--	--	up to 2300 RPM	--	above 2300 RPM
Oil pressure	below 1.0 bar	1.0 to 2.3 bar	2.3 to 5.8 bar	5.8 to 6.5 bar	above 6.5 bar
Oil temp.	below -30°C	-30 to 50 °C	50 to 130 °C	131 to 140 °C	above 140 °C
Coolant temp.	below -30 °C	-30 to 60 °C	60 to 101 °C	102 to 105 °C	above 105 °C
Gearbox temp.	--	--	up to 115 °C	115 to 120 °C	above 120 °C
Load	--	--	0 to 100 %	--	--
Fuel temp.	below -30 °C	-30 to +4 °C	+5 to 69 °C	70 to 75 °C	above 75 °C
Ammeter	--	--	up to 60 A	--	above 60 A
Volt- meter	below 24.1 V	24.1 to 25 V	25 to 30 V	30 to 32 V	above 32 V
Fuel qty.	0 US gal	--	0 to 25 US gal	--	--

2.6 WARNING, CAUTION AND ADVISORY ALERTS

2.6.1 WARNING, CAUTION AND ADVISORY ALERTS ON THE G1000

NOTE

The alerts described in the following are displayed on the Garmin G1000. Section 7.10 includes a detailed description of the alerts.

The following tables show the color and significance of the warning, caution and advisory alerts lights on the G1000.

Color and significance of the warning alerts on the G1000

Warning alerts (red)	Meaning / Cause
WARNING	One of the Warnings listed below is being indicated.
L/R ENG TEMP	Left / Right engine coolant temperature is in the upper red range (too high/>105 °C).
L/R OIL TEMP	Left / Right engine oil temperature is in the upper red range (too high/>140 °C).
L/R OIL PRES	Left / Right engine oil pressure is in the lower red range (too low/<1.0 bar).
L/R FUEL TEMP	Left / Right fuel temperature is in the upper red range (too high/>75 °C)
L/R GBOX TEMP	Left / Right engine gearbox temperature is in the upper red range (too high/>120 °C).
L/R ALTNAMPS	Left / Right engine alternator output is in the upper red range (too high/>60 amps).
L/R ENG FIRE	Left / Right engine fire detected.

Warning alerts (red)	Meaning / Cause
L/R STARTER	Left / Right engine starter is engaged.
DOOR OPEN	Front and/or rear canopy and/or baggage door are/is not closed and locked.
POSN ERROR	G1000 will no longer provide GPS based navigational guidance.
ATTITUDE FAIL	The display system is not receiving attitude reference information from the AHRS.
AIRSPEED FAIL	The display system is not receiving airspeed input from the air data computer.
ALTITUDE FAIL	The display system is not receiving altitude input from the air data computer.
VERT SPEED FAIL	The display system is not receiving vertical speed input from the air data computer.
HDG	The display system is not receiving valid heading input from the AHRS.
WARN	RAIM position warning. The nav deviation bar is removed.

Color and significance of the caution alerts on the G1000

Caution alerts (amber)	Meaning / Cause
L/R ECU A FAIL	* A fault has occurred in the left/right engine ECU A (one reset of minor faults is possible) or * ECU A is being tested during FADEC-test procedure during the 'before take-off check'.
L/R ECU B FAIL	* A fault has occurred in the left/right engine ECU B (one reset of minor faults is possible) or * ECU B is being tested during FADEC-test procedure during the 'before take-off check'.
L/R FUEL LOW	Left / Right main tank fuel quantity is low.
L/R ALTN FAIL	Left / Right engine alternator has failed.
L/R VOLTS LOW	Left / Right engine bus voltage is too low (< 25 volts).
L/R COOL LVL	Left / Right engine coolant level is low.
PITOT FAIL	Pitot heat has failed.
PITOT HT OFF	Pitot heat is OFF.
STAL HT FAIL	Stall warning heat has failed.
STAL HT OFF	Stall warning heat is OFF.
STICK LIMIT	Control stick limiting system (variable elevator stop) has failed.
INTEG RAIM not available	RAIM (Receiver Autonomous Integrity Monitor) is not available.
AHRS ALIGN: Keep Wings Level	The AHRS (Attitude and Heading Reference System) is aligning.
L/R AUX FUEL E	Left / Right auxiliary fuel tank empty (if installed).
CHECK GEAR (if installed)	Landing gear is not down and locked.

Color and significance of the advisory alerts on the G1000

Advisory alerts (white)	Meaning / Cause
L/R GLOW ON	Left/Right engine glow plug active.
L/R FUEL XFER	Fuel transfer from auxiliary to main tank is in progress.
PFD FAN FAIL	Cooling fan for the PFD is inoperative.
MFD FAN FAIL	Cooling fan for the MFD is inoperative.
GIA FAN FAIL	Cooling fan for the GIAs is inoperative.

2.6.2 OTHER WARNING ALERTS

Warning alerts on the instrument panel

GEAR UNSAFE WARNING LIGHT (red)	Illuminates if the landing gear is neither in the final up nor in the down & locked position.
---------------------------------------	---

Audible warning alerts

GEAR RETRACTED CHIME TONE (repeating)	Resounds if the landing gear is retracted while the flaps move into position LDG or when the power lever is placed in a position below 25%.
--	---

2.7 MASS (WEIGHT)

Value		Mass (Weight)	
Minimum flight mass		1250 kg	2756 lb
Maximum take-off mass	MÄM 42-088 not carried out	1700 kg	3748 lb
	MÄM 42-088 carried out	1785 kg	3935 lb
Maximum zero fuel mass		1650 kg	3638 lb
Maximum landing mass (see NOTE below)		1700 kg	3748 lb
Max. load in nose baggage compartment (in fuselage nose)		30 kg	66 lb
Max. load in cabin baggage compartment (behind rear seats)		45 kg	100 lb
Max. load in baggage extension (behind cabin baggage compartment)		18 kg	40 lb
Max. load, cabin baggage compartment and baggage extension together		45 kg	100 lb

WARNING

Exceeding the mass limits will lead to overstressing of the airplane as well as to degradation of flight characteristics and flight performance.

NOTE

In some countries the beginning of a flight is defined by starting the powerplant. In those countries a ramp mass of maximal MTOM + 8 kg (MTOM + 18 lb) is approved. At the time of lift-off the maximum permitted take-off mass must not be exceeded.

NOTE

If MÄM 42-088 is carried out, a landing with a mass between 1700 kg (3748 lb) and 1785 kg (3935 lb) is admissible. It constitutes an abnormal operating procedure. A "Hard Landing Check" is only required after a hard landing, regardless of the actual landing mass.

2.8 CENTER OF GRAVITY

Datum Plane

The Datum Plane (DP) is a plane which is normal to the airplane's longitudinal axis and in front of the airplane as seen from the direction of flight. The airplane's longitudinal axis is parallel with the floor of the nose baggage compartment. When the floor of the nose baggage compartment is aligned horizontally, the Datum Plane is vertical. The Datum Plane is located 2.196 meters (86.46 in) forward of the most forward point of the root rib on the stub wing (refer to figure in Section 6.2).

Center of gravity limitations

The center of gravity (CG position) for flight conditions must be between the following limits:

Most forward flight CG:

- 2.35 m (92.52 in) aft of Datum Plane at 1250 kg (2756 lb)
 - 2.35 m (92.52 in) aft of Datum Plane at 1468 kg (3236 lb)
 - 2.40 m (94.49 in) aft of Datum Plane at max. take-off mass (see Section 2.7)
- linear variation in between

Most rearward flight CG:

- 2.42 m (95.28 in) aft of Datum Plane at 1250 kg (2756 lb)
 - 2.49 m (98.03 in) aft of Datum Plane at 1600 kg (3527 lb)
 - 2.49 m (98.03 in) aft of Datum Plane at max. take-off mass (see Section 2.7)
- linear variation in between

Refer to Section 6.4.4 for a graphical illustration of the CG limitations.

WARNING

Exceeding the center of gravity limitations reduces the controllability and stability of the airplane.

2.9 APPROVED MANEUVERS

The airplane is certified in the Normal Category in accordance with JAR-23.

Approved maneuvers

- 1) all normal flight maneuvers;
- 2) stalling (with the exception of dynamic stalling); and
- 3) Lazy Eights, Chandelles, as well as steep turns and similar maneuvers, in which an angle of bank of not more than 60° is attained.

CAUTION

Aerobatics, spinning and flight maneuvers with more than 60° of bank are not permitted in the Normal Category. Stalling with asymmetric power or one engine inoperative is not permitted.

2.10 MANEUVERING LOAD FACTORS

NOTE

The tables below show structural limitations. The load factor limits for the TAE 125 engine must also be observed. Refer to the corresponding Operation & Maintenance Manual for the engine.

CAUTION

Avoid extended negative g-loads duration. Extended negative g-loads can cause propeller control problems and engine surging.

	at v_A	at v_{NE}	with flaps in APP or LDG position
Positive	3.8	3.8	2.0
Negative	-1.52	0	

WARNING

Exceeding the maximum structural load factors will lead to overstressing of the airplane.

CAUTION

Exceeding the maximum powerplant load factors and time limits listed below will lead to a L/R OIL PRES warning.

load factor	time limit
-0.2	5 seconds
-0.3	4 seconds
-0.4	3 seconds
-0.5	2 seconds

2.11 OPERATING ALTITUDE

The maximum operating altitude is 18,000 ft (5,486 m) pressure altitude.

2.12 FLIGHT CREW

Minimum crew : 1 (one person)

Maximum number of occupants : 4 (four persons)

2.13 KINDS OF OPERATION

Provided that national operational requirements are met, the following kinds of operation are approved:

- daytime flights according to Visual Flight Rules (VFR)
- with the appropriate equipment: night flights according to Visual Flight Rules (VFR)
- with the appropriate equipment: flights according to Instrument Flight Rules (IFR)
- take-off and landing on paved surfaces
- take-off and landing on grass surfaces
- If OÄM 42-054 is carried out: flight into known or forecast icing conditions. Refer to Supplement S03, latest revision.

Flights into known thunderstorms are prohibited.

Minimum operational equipment (serviceable)

The following table lists the minimum serviceable equipment required by JAR-23. Additional minimum equipment for the intended operation may be required by national operating rules and also depends on the route to be flown.

NOTE

Many of the items of minimum equipment listed in the following table are integrated in the G1000.

Doc. No. 7.01.05-E	Rev. 5	15-Nov-2007	Page 2 - 19
--------------------	--------	-------------	-------------

	for daytime VFR flights	in addition for night VFR flights	in addition for IFR flights
Flight & navigation instruments	<ul style="list-style-type: none"> * airspeed indicator (on G1000 PFD or backup) * altimeter (on G1000 PFD or backup) * magnetic compass * 1 headset, used by pilot in command 	<ul style="list-style-type: none"> * vertical speed indicator (VSI) * attitude gyro (artificial horizon; on G1000 PFD or backup) * turn & bank indicator (on G1000 PFD) * directional gyro * VHF radio (COM) with speaker and microphone * VOR receiver * transponder (XPDR), mode A and mode C * GPS receiver (part of G1000) 	<ul style="list-style-type: none"> * second airspeed indicator (both, on G1000 PFD and backup) * second altimeter (both, on G1000 PFD and backup) * second attitude gyro (both, on G1000 PFD and backup) * second VHF radio (COM) * VOR-LOC-GP receiver * second GPS receiver (part of G1000)
engine instruments	<ul style="list-style-type: none"> * fuel qty. (2x) * oil press. (2x) * oil temp. (2x) * coolant temp. (2x) * coolant level indicator (2x) * gearbox temp. (2x) * load (2x) * prop. RPM (2x) * fuel temp. left & right tank 	<ul style="list-style-type: none"> * ammeter * voltmeter 	

	for daytime VFR flights	in addition for night VFR flights	in addition for IFR flights
lighting		<ul style="list-style-type: none"> * position lights * strobe lights (anti collision lights) * landing light * instrument lighting * flood light * flashlight 	
other operational minimum equipment	<ul style="list-style-type: none"> * stall warning system * variable elevator stop * alternate means for fuel quantity indication (see Section 7.9) * safety belts for each occupied seat * Airplane Flight Manual 	<ul style="list-style-type: none"> * Pitot heating system * alternate static valve 	<ul style="list-style-type: none"> * emergency battery (for backup attitude gyro and flood light)

NOTE

A list of approved equipment can be found in Chapter 6.

2.14 FUEL

- Approved fuel grades: JET A-1 (ASTM D 1655),
JET A (ASTM D 1655),
Jet Fuel No. 3 (GB6537-94),
and blends of the above listed Jet Fuel grades.
- Only if MÄM 42-037 is incorporated: Diesel (EN 590)
and blends of the above listed Jet Fuel grades
and Diesel.

CAUTION

Limitations for DA 42 registered and/or operated in the following countries:

Indonesia, Malaysia: Use of Diesel Fuel is NOT approved.

CAUTION

If the airplane is operated with Diesel Fuel or a blend of Diesel Fuel with Jet Fuel, the use of the auxiliary tanks, if installed (OÄM 42-056), is not permitted.

CAUTION

Additional temperature limitations must be observed if the airplane is operated with Diesel Fuel or blends of Diesel Fuel with Jet Fuel. Refer to Section 2.16.1.

NOTE

Use only uncontaminated fuel from reliable sources.

	Main Tanks		Auxiliary Tanks (if installed)		Total	
	US gal	liters	US gal	liters	US gal	liters
Total fuel quantity	2 x 26.0	2 x 98.4	2 x 13.7	2 x 52.0	2 x 39.7	2 x 150.4
Usable fuel	2 x 25.0	2 x 94.6	2 x 13.2	2 x 50.0	2 x 38.2	2 x 144.6
Max. permissible difference LH/RH	5.0	18.9				

2.15 LIMITATION PLACARDS

All *limitation* placards are shown below. A list of *all* placards is included in the Airplane Maintenance Manual (Doc. No. 7.02.01), Chapter 11.

On the instrument panel:

*MÄM 42-088 or
OÄM 42-054 or
both
incorporated:*

THIS AIRPLANE MAY ONLY BE OPERATED IN ACCORDANCE WITH THE AIRPLANE FLIGHT MANUAL IN THE "NORMAL" CATEGORY. PROVIDED THAT NATIONAL OPERATIONAL REQUIREMENTS ARE MET AND THE APPROPRIATE EQUIPMENT IS INSTALLED AND OPERATIONAL, THIS AIRPLANE IS APPROVED FOR THE FOLLOWING KINDS OF OPERATION: DAY VFR, NIGHT VFR AND IFR, AND FLIGHT INTO KNOWN OR FORECAST ICING CONDITIONS. ALL AEROBATIC MANEUVERS INCLUDING SPINNING ARE PROHIBITED. FOR FURTHER OPERATIONAL LIMITATIONS REFER TO THE AIRPLANE FLIGHT MANUAL.

MANEUVERING SPEED:

$V_A = 126$ KIAS (ABOVE 1542 KG / 3400 LB)

$V_A = 120$ KIAS (UP TO 1542 KG / 3400 LB)

*neither
MÄM 42-088 nor
OÄM 42-054
incorporated:*

THIS AIRPLANE MAY ONLY BE OPERATED IN ACCORDANCE WITH THE AIRPLANE FLIGHT MANUAL. IT CAN BE OPERATED IN THE "NORMAL" CATEGORY IN NON-ICING CONDITIONS. PROVIDED THAT NATIONAL OPERATIONAL REQUIREMENTS ARE MET AND THE APPROPRIATE EQUIPMENT IS INSTALLED, THIS AIRPLANE IS APPROVED FOR THE FOLLOWING KIND OF OPERATION: DAY VFR, NIGHT VFR AND IFR. ALL AEROBATIC MANEUVERS INCLUDING SPINNING ARE PROHIBITED. FOR FURTHER OPERATIONAL LIMITATIONS REFER TO THE AIRPLANE FLIGHT MANUAL.

MANEUVERING SPEED:

$V_A = 124$ KIAS (ABOVE 1468 UP TO 1700 KG / ABOVE 3236 UP TO 3748 LB)

$V_A = 121$ KIAS (1250 TO 1468 KG / 2756 TO 3236 LB)

LANDING GEAR

$V_{LE} / V_{LOE} = 194$ KIAS

$V_{LOR} = 156$ KIAS

On the Emergency Landing Gear Extension Lever:

EMERGENCY

Gear Extension

Max. 156 KIAS

On the instrument panel, next to the fuel quantity indication:

(a) *Standard Tank:*

**max. usable
fuel: 2 x 25 US gal**
max. difference LH/RH
tank: 5 US gal

(b) *Auxiliary Tank (if installed):*

**max. usable fuel
main tank:
2 x 25 US gal
auxiliary tank:
2 x 13 US gal**
max. difference LH/RH
main tank: 5 US gal

if MÄM 42-037 is carried out, on the Garmin G1000 MFD next to the fuel temperature indication:

**Diesel Fuel or
Unknown Fuel Blend:**
Below -5 °C:
No engine start permitted.
Below +5 °C:
No take-off permitted.

(a) Next to each of the two fuel filler necks;

(b) in addition next to each of the two auxiliary fuel filler necks (if installed):

WARNING
APPROVED FUEL
JET-A1
or see Airplane Flight Manual

In each cowling, on the door for the oil filler neck:

OIL
Shell Helix Ultra
5W30 synth.
API SL/CF
or see AFM

Next to the flap selector switch:

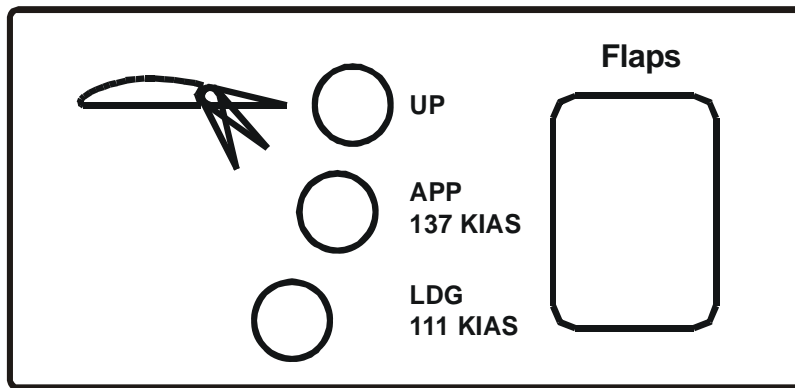

| In the cabin, on the left fuselage sidewall:

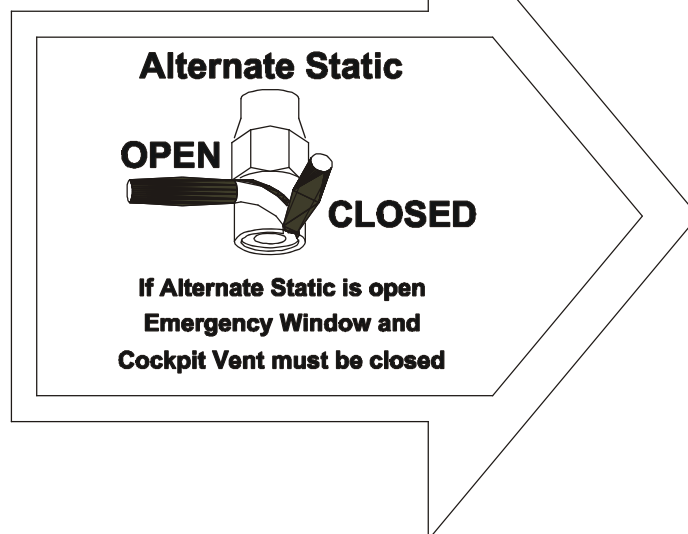

Next to the cabin baggage compartment:

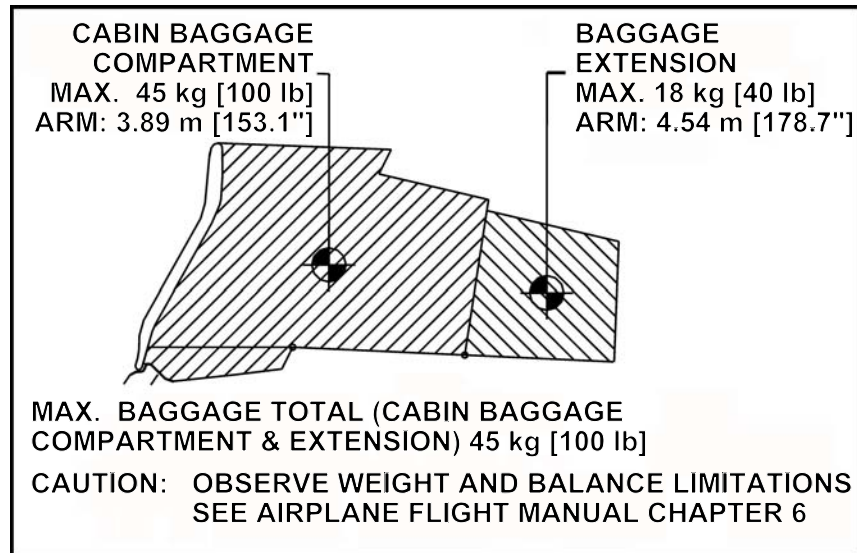

In the nose baggage compartment:

Max. Baggage:

30 kg [66 lb]

Beside the door locking device installed in the passengers' door:

EMERGENCY EXIT:

The keylock must be
 unlocked during flight

On the right-hand side of the instrument panel above the circuit breakers:

— NO SMOKING —

2.16 OTHER LIMITATIONS

2.16.1 FUEL TEMPERATURE

- █ JET A-1, JET A and Jet Fuel No. 3:
 - █ from -30 °C to +75 °C (from -22 °F to +167 °F)

NOTE

Operation with Diesel Fuel, or blends of Diesel Fuel with Jet Fuel, is only approved when MÄM 42-037 is incorporated.

- █ Diesel Fuel, Blends of Diesel Fuel with Jet Fuel, or unknown fuel grade:
 - █ Engine starting fuel temperature min. -5 °C (+23 °F)
 - █ Take-off fuel temperature min. +5 °C (+41 °F)
 - █ Maximum fuel temperature +75 °C (+167 °F)

2.16.2 BATTERY CHARGE

Taking off for a Night VFR or IFR flight with an empty battery is not permitted.

The use of an external power supply for engine starting with an empty airplane battery is also not permitted if the subsequent flight is intended to be a Night VFR or IFR flight. In this case the airplane battery must first be charged.

2.16.3 EMERGENCY SWITCH

IFR flights are not permitted when the seal on the emergency switch is broken.

2.16.4 DOOR LOCKING DEVICE

The canopy and the passenger door must not be blocked by the key lock during operation of the airplane.

2.16.5 ELECTRONIC EQUIPMENT

The use and switching on of electronic equipment other than that which is part of the equipment of the airplane is not permitted, as it could lead to interference with the airplane's avionics.

Examples of undesirable items of equipment are:

- Mobile phones
- Remote radio controls
- Video screens employing CRTs
- Minidisc recorders in record mode

This list is not exhaustive.

The use of laptop computers, including those with CD-ROM drives, CD and minidisc players in the replay mode, cassette players and video cameras is permitted. All this equipment however should be switched off for take-off and landing.

2.16.6 GARMIN G1000 AVIONICS SYSTEM

1. The Garmin G1000 Cockpit Reference Guide, P/N 190-00406-00, dated September 2004 or later appropriate revision must be immediately available to the flight crew.
2. If MÄM-42-101 has been implemented (refer to Section 1.1), the G1000 must utilize the software Garmin P/N: 010-00370-11, or later approved software in accordance with the mandatory service bulletin DAI MSB 42-008, latest version.
3. If MÄM 42-198 (TAE 125-02-99 engines, refer to Section 1.1) is implemented, the G1000 must utilize the software Garmin P/N 010-00370-15, or later approved software in accordance with the mandatory service bulletin DAI MSB42-008, latest version.

Software Part Number	Approved Version	Function
System	for approved version see DAI MSB 42-008, latest version	
010-00370-()		
Manifest		
006-B0093-()		GPS1, GPS2
006-B0172-()		GTX1-GIA1, GTX1-GIA2
006-B0190-()		GIA1, GIA2
006-B0193-()		GEA1-GIA1; GEA1-GIA2
006-B0203-()		GMA1-GIA1, GMA1-GAI2
006-B0223-()		GRS1-GIA1, GRS1-GIA2
006-B0224-()		GMU1
006-B0319-()		PFD1, MFD1
006-B0328-()		
006-B0329-()		
006-C0048-()		GMU1 FPGA
006-C0049-()		GRS1 FPGA
006-C0055-()		GDC1 FPGA
006-D0159-()		GRS1 MV DB

Software Part Number	Approved Version	Function
006-D0202-()	for approved version see DAI MSB 42-008, latest version	
006-B0261-()		GDC1-GIA1
006-B0081-()		COM1, COM2
006-B0083-()		GS1, GS2
006-B0082-()		NAV1, NAV2

NOTE

The database version is displayed on the MFD power-up page immediately after system power-up and must be acknowledged. The remaining system software versions can be verified on the AUX group sub-page 5, "AUX-SYSTEM STATUS".

4. IFR enroute, oceanic and terminal navigation predicated upon the G1000 GPS Receiver is prohibited unless the pilot verifies the currency of the database or verifies each selected way point for accuracy by reference to current approved data.
5. Instrument approach navigation predicated upon the G1000 GPS Receiver must be accomplished in accordance with approved instrument approach procedures that are retrieved from the GPS equipment database. The GPS equipment database must incorporate the current update cycle.

NOTE

Not all published approaches are in the FMS database. The pilot must ensure that the planned approach is in the database.

- (a) Instrument approaches utilizing the GPS receiver must be conducted in the approach mode and Receiver Autonomous Integrity Monitoring (RAIM) must be available at the Final Approach Fix.
 - (b) Accomplishment of ILS, LOC, LOC-BC, LDA, SDF, MLS or any other type of approach not approved for GPS overlay with the G1000 GPS receiver is not authorized.
 - (c) Use of the G1000 VOR/ILS receiver to fly approaches not approved for GPS require VOR/ILS navigation data to be present on the display.
 - (d) When an alternate airport is required by the applicable operating rules, it must be served by an approach based on other than GPS or Loran-C navigation, the airplane must have the operational equipment capable of using that navigation aid, and the required navigation aid must be operational.
 - (e) VNAV information may be utilized for advisory information only. Use of VNAV information for Instrument Approach Procedures does not guarantee step-down fix altitude protection, or arrival at approach minimums in normal position to land.
 - (f) RNAV (GPS) approaches must be conducted utilizing the GPS sensor.
 - (g) RNP RNAV operations are not authorized, except as noted in Chapter 1 of this AFM.
6. If not previously defined, the following default settings must be made in the "SYSTEM SETUP" menu of the G1000 prior to operation (refer to Pilot's Guide for procedure if necessary):
- (a) DIS, SPD : nm, kt (sets navigation units to "nautical miles" and "knots")
 - (b) ALT, VS : ft, fpm (sets altitude units to "feet" and "feet per minute")
 - (c) MAP DATUM : WGS 84 (sets map datum to WGS-84, see note below)
 - (d) POSITION : deg-min (sets navigation grid units to decimal minutes)

NOTE

In some areas, datums other than WGS-84 or NAD-83 may be used. If the G1000 is authorized for use by the appropriate Airworthiness Authority, the required geodetic datum must be set in the G1000 prior to its use for navigation.

7. When AHRS is required to meet the items listed in the Minimum operational equipment (serviceable) table in Section 2.13 of this AFM, operation is prohibited in the following areas:

- (a) north of 70° N and south of 70° S latitudes,
- (b) north of 65° N between 75° W and 120° W longitude, and
- (c) south of 55° S between 120° E and 165° E longitude.

When day VFR operations are conducted in the above areas, the MFD must be in a non-Heading Up orientation.

8. CDI sequencing of the ILS must be set to MANUAL for instrument approaches conducted with the autopilot coupled. If the CDI source is changed when the autopilot is engaged in NAV mode, the autopilot lateral mode will revert to ROLL ATTITUDE mode and NAV mode must be manually reselected by the pilot.

9. The fuel quantity, fuel required, and fuel remaining functions on the Fuel Page (displayed when pushing the FUEL button as shown in Section 7.13) of the FMS are supplemental information only and must be verified by the flight crew.

10. The pilot's altimeter is the primary altitude reference during all operations using advisory vertical navigation (VNAV) information and the autopilot. A flight altitude selected via the autopilot must be verified and corrected according to the indication of the calibrated altimeter.

2.16.7 SMOKING

Smoking in the airplane is not permitted.

2.16.8 GROUND OPERATION

Take-off and landing has been demonstrated on hard paved surfaces (asphalt, concrete, etc.) and grass runways.

2.16.9 USE OF THE SUN VISORS

- █ The sun visors (if installed, OAM 42-101) may only be used during cruise. During all other phases of flight the sun visors must be locked in the fully upward position.

CHAPTER 3

EMERGENCY PROCEDURES

	Page
3.1 INTRODUCTION	3-4
3.1.1 GENERAL	3-4
3.1.2 CERTAIN AIRSPEEDS IN EMERGENCIES	3-5
3.1.3 SELECTING EMERGENCY FREQUENCY	3-5
3.2 AIRPLANE-RELATED G1000 WARNINGS	3-6
3.2.1 WARNINGS / GENERAL	3-6
3.2.2 L/R ENG TEMP	3-6
3.2.3 L/R OIL TEMP	3-8
3.2.4 L/R OIL PRES	3-9
3.2.5 L/R GBOX TEMP	3-10
3.2.6 L/R FUEL TEMP	3-11
3.2.7 L/R ALTN AMPS	3-12
3.2.8 L/R ENG FIRE	3-12
3.2.9 L/R STARTER	3-13
3.2.10 DOOR OPEN	3-13
3.3 G1000 SYSTEM WARNINGS	3-14
3.3.1 RED X	3-14
3.3.2 POSN ERROR	3-14
3.3.3 ATTITUDE FAIL	3-14
3.3.4 AIRSPEED FAIL	3-14
3.3.5 ALTITUDE FAIL	3-15
3.3.6 VERT SPEED FAIL	3-15
3.3.7 HDG	3-15
3.3.8 WARN	3-15

3.4	G1000 FAILURES	3-16
3.4.1	NAVIGATION INFORMATION FAILURE	3-16
3.4.2	PFD OR MFD DISPLAY FAILURE	3-16
3.4.3	AHRS FAILURE	3-17
3.4.4	AIR DATA COMPUTER (ADC) FAILURE	3-17
3.4.5	ERRONEOUS OR LOSS OF ENGINE AND FUEL DISPLAYS	3-18
3.4.6	ERRONEOUS OR LOSS OF WARNING/CAUTION ANNUNCIATORS	3-19
3.5	ONE ENGINE INOPERATIVE PROCEDURES	3-20
3.5.1	DETECTING THE INOPERATIVE ENGINE	3-20
3.5.2	ENGINE TROUBLESHOOTING	3-21
3.5.3	ENGINE SECURING (FEATHERING) PROCEDURE	3-24
3.5.4	UNFEATHERING & RESTARTING THE ENGINE IN FLIGHT	3-25
3.5.5	ENGINE FAILURE DURING TAKE-OFF	3-29
3.5.6	ENGINE FAILURES IN FLIGHT	3-32
3.5.7	LANDING WITH ONE ENGINE INOPERATIVE	3-35
3.5.8	GO-AROUND / BALKED LANDING WITH ONE ENGINE INOPERATIVE	3-38
3.5.9	FLIGHT WITH ONE ENGINE INOPERATIVE	3-40
3.6	LANDING GEAR SYSTEM FAILURES	3-41
3.6.1	LANDING GEAR UNSAFE WARNING	3-41
3.6.2	MANUAL EXTENSION OF THE LANDING GEAR	3-43
3.6.3	LANDING WITH GEAR UP	3-45
3.6.4	LANDING WITH A DEFECTIVE TIRE ON THE MAIN LANDING GEAR	3-46
3.6.5	LANDING WITH DEFECTIVE BRAKES	3-47
3.7	FAILURES IN THE ELECTRICAL SYSTEM	3-48
3.7.1	COMPLETE FAILURE OF THE ELECTRICAL SYSTEM ..	3-48
3.7.2	HIGH CURRENT	3-49

- 3.7.3 STARTER MALFUNCTION 3-49
- 3.8 SMOKE AND FIRE 3-50
 - 3.8.1 ENGINE FIRE ON GROUND 3-50
 - 3.8.2 ENGINE FIRE DURING TAKE-OFF 3-50
 - 3.8.3 ENGINE FIRE IN FLIGHT 3-51
 - 3.8.4 ELECTRICAL FIRE ON GROUND 3-52
 - 3.8.5 ELECTRICAL FIRE IN FLIGHT 3-53
- 3.9 OTHER EMERGENCIES 3-54
 - 3.9.1 SUSPICION OF CARBON MONOXIDE CONTAMINATION IN THE CABIN 3-54
 - 3.9.2 UNLOCKED DOORS 3-55
 - 3.9.3 DEFECTIVE PROPELLER RPM REGULATING SYSTEM .. 3-56
 - 3.9.4 UNINTENTIONAL FLIGHT INTO ICING 3-58
 - 3.9.5 FUEL SUPPLY FAILURE 3-59
 - 3.9.6 RECOVERY FROM AN UNINTENTIONAL SPIN 3-60
 - 3.9.7 EMERGENCY DESCENT 3-62
 - 3.9.8 EMERGENCY EXIT 3-62

NOTE

Procedures for uncritical system faults are given in Chapter 4B - ABNORMAL OPERATING PROCEDURES.

3.1 INTRODUCTION

3.1.1 GENERAL

This chapter contains checklists as well as the description of recommended procedures to be followed in the event of an emergency. Engine failure or other airplane-related emergencies are most unlikely to occur if the prescribed procedures for pre-flight checks and airplane maintenance are followed.

If, nonetheless, an emergency does arise, the guidelines given in this chapter should be followed and applied in order to clear the problem.

As it is impossible to foresee all kinds of emergencies and cover them in this Airplane Flight Manual, a thorough understanding of the airplane by the pilot is, in addition to his knowledge and experience, an essential factor in the solution of any problems which may arise.

WARNING

In each emergency, control over the flight attitude and the preparation of a possible emergency landing have priority over attempts to solve the current problem ("first fly the aircraft"). Prior to the flight the pilot must consider the suitability of the terrain for an emergency landing for each phase of the flight. For a safe flight the pilot must constantly keep a safe minimum flight altitude. Solutions for various adverse scenarios should be thought over in advance. This should prevent a situation where the pilot is faced with an emergency he cannot handle calmly and with determination.

3.1.2 CERTAIN AIRSPEEDS IN EMERGENCIES

Event	Airspeed
One engine inoperative minimum control speed (Air) v_{mCA}	68 KIAS
One engine inoperative speed for best rate of climb v_{YSE}	82 KIAS

3.1.3 SELECTING EMERGENCY FREQUENCY

In an in-flight emergency, depressing and holding the Com transfer button \leftrightarrow on the G1000 for 2 seconds will tune the emergency frequency of 121.500 MHz. If the display is available, it will also show it in the "Active" frequency window.

3.2 AIRPLANE-RELATED G1000 WARNINGS

3.2.1 WARNINGS / GENERAL

"Warning" means that the non-observation of the corresponding procedure leads to an immediate or important degradation in flight safety. The warning text is displayed in red color. A warning chime tone of 1.5 seconds duration will sound and repeat without delay until the alarm is acknowledged by the crew.

3.2.2 L/R ENG TEMP

L/R ENG TEMP	Left / Right engine coolant temperature is in the upper red range (too high / above 105 °C)
---------------------	---

Coolant temperatures above the limit value of 105 °C can lead to a total loss of power due to engine failure.

- Check G1000 for L/R COOL LVL caution message (low coolant level).

L/R COOL LVL caution message not displayed:

during climb:

- Reduce power on affected engine by 10 % or more as required.
- Increase airspeed by 10 KIAS or more as required.
- If the coolant temperature does not reach the green range within 60 seconds, reduce power on affected engine as far as possible and increase airspeed.

CONTINUED

Page 3 - 6	Rev. 5	15-Nov-2007	Doc. No. 7.01.05-E
------------	--------	-------------	--------------------

during cruise:

- Reduce power on affected engine.
- Increase airspeed.
- Check coolant temperature in green range.

CAUTION

If high coolant temperature is indicated and the L/R COOL LVL caution message is not displayed, it can be assumed that there is no technical defect in the cooling system and that the above mentioned procedure can decrease the temperature(s). This might not be the case if the coolant temperature does not return to the green range. In this case perform a precautionary landing on the nearest suitable airfield. Prepare for an engine failure in accordance with 3.5.6 - ENGINE FAILURES IN FLIGHT.

L/R COOL LVL caution message displayed:

- Reduce power on affected engine.
- Expect loss of coolant.

WARNING

A further increase in coolant temperature must be expected. Prepare for an engine failure in accordance with 3.5.6 - ENGINE FAILURES IN FLIGHT.

END OF CHECKLIST

3.2.3 L/R OIL TEMP

L/R OIL TEMP	Left / Right engine oil temperature is in the upper red range (too high / above 140 °C).
---------------------	--

Oil temperatures above the limit value of 140 °C can lead to a total loss of power due to engine failure.

- Check oil pressure.

If the oil pressure is outside of the green range (lower limit):

- Reduce power on affected engine.
- Expect loss of engine oil.

WARNING

A further increase in oil temperature must be expected.
Prepare for an engine failure in accordance with
3.5.6 - ENGINE FAILURES IN FLIGHT.

if the oil pressure is within the green range:

- Reduce power on affected engine.
- Increase airspeed.

CAUTION

If high oil temperature is announced and the oil pressure indication is within the green range, it can be assumed that there is no technical defect in the engine oil system and that the above mentioned procedure can decrease the temperature(s). This might not be the case if the oil temperature does not return to the green range. In this case perform a precautionary landing on the nearest suitable airfield. Prepare for an engine failure in accordance with 3.5.6 - ENGINE FAILURES IN FLIGHT.

END OF CHECKLIST

Page 3 - 8	Rev. 5	15-Nov-2007	Doc. No. 7.01.05-E
------------	--------	-------------	--------------------

3.2.4 L/R OIL PRES**L/R OIL PRES**

Left / Right engine oil pressure is in the lower red range (too low / below 1 bar).

Oil pressures below the limit value of 1 bar can lead to a total loss of power due to engine failure.

- Reduce power on affected engine.
- Expect loss of oil.

WARNING

Land at the nearest suitable airfield. Prepare for an engine failure in accordance with 3.5.6 - ENGINE FAILURES IN FLIGHT.

END OF CHECKLIST

3.2.5 L/R GBOX TEMP

L/R GBOX TEMP	Left / Right engine gearbox temperature is in the upper red range (too high / above 120 °C).
----------------------	--

Gearbox temperatures above the limit value of 120 °C can lead to a total loss of power due to engine failure.

- Reduce power on affected engine.
- Increase airspeed.

CAUTION

At high ambient temperature conditions and/or at low airspeeds with high power settings, it can be assumed that there is no technical defect in the gearbox and that the above mentioned procedure will decrease the temperature(s). This might not be the case if the gearbox temperature does not return to the green range. In this case perform a precautionary landing on the nearest suitable airfield. Prepare for an engine failure in accordance with 3.5.6 - ENGINE FAILURES IN FLIGHT.

END OF CHECKLIST

Page 3 - 10	Rev. 5	15-Nov-2007	Doc. No. 7.01.05-E
-------------	--------	-------------	--------------------

3.2.6 L/R FUEL TEMP

L/R FUEL TEMP	Left / Right fuel temperature is in the upper red range (too high / above 75 °C).
----------------------	---

Fuel temperatures above the limit value of 75 °C can lead to a noticeable reduction of the high pressure pump efficiency.

- Reduce power on affected engine.
- Increase airspeed.

CAUTION

At high ambient temperature conditions and/or at low airspeeds with high power settings and low fuel quantities, it can be assumed that the above mentioned procedure will decrease the temperature(s). If the fuel temperature does not return to the green range, perform a precautionary landing on the nearest suitable airfield.

NOTE

Increased fuel temperature can occur when the fuel quantity in the main tank is low. If the auxiliary tank is installed the fuel temperature can be decreased by transferring fuel from the auxiliary to the main tank.

END OF CHECKLIST

3.2.7 L/R ALTN AMPS

L/R ALTN AMPS	Left / Right engine alternator output is in the upper red range (too high / above 60 amps).
----------------------	---

Proceed according to:

3.7.2 - HIGH CURRENT

3.2.8 L/R ENG FIRE

L/R ENG FIRE	Left / Right engine fire detected
---------------------	-----------------------------------

Engine fire can lead to a total loss of power due to engine failure as well as severe structural damage:

Proceed according to the following procedures as applicable:

3.8.1 - ENGINE FIRE ON GROUND

3.8.2 - ENGINE FIRE DURING TAKE-OFF

3.8.3 - ENGINE FIRE IN FLIGHT

3.2.9 L/R STARTER

L/R STARTER	Left / Right engine starter is engaged
--------------------	--

Proceed according to:

3.7.3 - STARTER MALFUNCTION**3.2.10 DOOR OPEN**

DOOR OPEN	Front and/or rear canopy and/or baggage door are/is not closed and locked.
------------------	--

Proceed according to:

3.9.2 - UNLOCKED DOORS

Doc. No. 7.01.05-E	Rev. 5	15-Nov-2007	Page 3 - 13
--------------------	--------	-------------	-------------

3.3 G1000 SYSTEM WARNINGS

3.3.1 RED X

A red X through any display field, such as COM frequencies, NAV frequencies, or engine data, indicates that display field is not receiving valid data.

3.3.2 POSN ERROR

POSN ERROR	The system will flag and no longer provide GPS based navigational guidance.
-------------------	---

Revert to the G1000 VOR/ILS receivers or an alternate means of navigation other than the G1000 GPS receivers.

3.3.3 ATTITUDE FAIL

ATTITUDE FAIL	The display system is not receiving attitude reference information from the AHRS; accompanied by the removal of sky/ground presentation and a red X over the attitude area.
----------------------	---

Revert to the standby attitude indicator.

3.3.4 AIRSPEED FAIL

AIRSPEED FAIL	The display system is not receiving airspeed input from the air data computer; accompanied by a red X through the airspeed display.
----------------------	---

Revert to the standby airspeed indicator.

Page 3 - 14	Rev. 5	15-Nov-2007	Doc. No. 7.01.05-E
-------------	--------	-------------	--------------------

3.3.5 ALTITUDE FAIL

ALTITUDE FAIL	The display system is not receiving altitude input from the air data computer; accompanied by a red X through the altimeter display.
----------------------	--

Revert to the standby altimeter.

3.3.6 VERT SPEED FAIL

VERT SPEED FAIL	The display system is not receiving vertical speed input from the air data computer; accompanied by a red X through the vertical speed display.
------------------------	---

Determine vertical speed based on the change of altitude information.

3.3.7 HDG

HDG	The display system is not receiving valid heading input from the AHRS; accompanied by a red X through the digital heading display.
------------	--

Revert to the emergency compass.

3.3.8 WARN

WARN	RAIM position warning - nav deviation bar removed.
-------------	--

1. CDI softkey switch to VOR/LOC

3.4 G1000 FAILURES

3.4.1 NAVIGATION INFORMATION FAILURE

If Garmin G1000 GPS navigation information is not available or invalid, utilize remaining operational navigation equipment as required.

3.4.2 PFD OR MFD DISPLAY FAILURE

1. DISPLAY BACKUP button on audio panel . . PUSH

Automatic Entry of Display Failure

- If the PFD and MFD have automatically entered reversionary mode, use the following procedure.

- (a) DISPLAY BACKUP button on audio panel . . PUSH (button will be OUT)

NOTE

After automatic entry of reversionary mode, the pilot must press the DISPLAY BACKUP button on the audio panel. After the DISPLAY BACKUP button has been pushed, the system will remain in reversionary mode even if the problem causing the automatic entry of reversionary mode is resolved. A maximum of one attempt to return to normal mode is approved using the following procedure.

- (b) DISPLAY BACKUP button on audio panel . . PUSH (button will be IN)

- If the system returns to normal mode, leave the DISPLAY BACKUP button IN and continue.
- If the system remains in reversionary mode, or abnormal display behavior such as display flashing occurs, then return the DISPLAY BACKUP button to the OUT position.

3.4.3 AHRS FAILURE

NOTE

A failure of the Attitude and Heading Reference System (AHRS) is indicated by a removal of the sky/ground presentation and a red X and a yellow "AHRS FAILURE" shown on the PFD. The digital heading presentation will be replaced with a yellow "HDG" and the compass rose digits will be removed. The course pointer will indicate straight up and course may be set using the digital window.

1. Use standby attitude indicator, emergency compass and Navigation Map
2. Course set using digital window

3.4.4 AIR DATA COMPUTER (ADC) FAILURE

NOTE

Complete loss of the Air Data Computer is indicated by a red X and yellow text over the airspeed, altimeter, vertical speed, TAS and OAT displays. Some FMS functions, such as true airspeed and wind calculations, will also be lost.

1. Use standby airspeed indicator and altimeter.

3.4.5 ERRONEOUS OR LOSS OF ENGINE AND FUEL DISPLAYS

NOTE

Loss of an engine parameter is indicated by a red X through the data field. Erroneous information may be identified by indications which do not agree with other system information. Erroneous indications may be determined by comparing a display with other displays and other system information.

1. Set power based on throttle lever position, engine noise and speed.
2. Monitor other indications to determine the health of the engine.
3. Use known power settings and performance data refer to 5.3.2 - FUEL FLOW DIAGRAM for approximate fuel flow values.
4. Use other system information, such as annunciator messages, GPS fuel quantity and flow, to safely complete the flight.

3.4.6 ERRONEOUS OR LOSS OF WARNING/CAUTION ANNUNCIATORS**NOTE**

Loss of an annunciator may be indicated when engine or fuel displays show an abnormal or emergency situation and the annunciator is not present. An erroneous annunciator may be identified when an annunciator appears which does not agree with other displays or system information.

1. If an annunciator appears, treat it as if the condition exists. Refer to Chapter 3 - EMERGENCY PROCEDURES or Chapter 4B - ABNORMAL OPERATING PROCEDURES.
2. If a display indicates an abnormal condition but no annunciator is present, use other system information, such as engine displays, GPS fuel quantity and flow, to determine if the condition exists. If it cannot be determined that the condition does not exist, treat the situation as if the condition exists. Refer to Chapter 3 - EMERGENCY PROCEDURES or Chapter 4B - ABNORMAL OPERATING PROCEDURES.

3.5 ONE ENGINE INOPERATIVE PROCEDURES

WARNING

In certain combinations of airplane weight, configuration, ambient conditions, speed and pilot skill, negative climb performance may result. Refer to Chapter 5 - PERFORMANCE for one engine inoperative performance data.

In any event the sudden application of power during one-engine inoperative operation makes the control of the airplane more difficult.

3.5.1 DETECTING THE INOPERATIVE ENGINE

NOTE

One engine inoperative means an asymmetric loss of thrust, resulting in uncommanded yaw and roll in direction of the so-called "dead" engine (with coordinated controls). To handle this situation it is vital to maintain directional control by mainly rudder and additional aileron input. The following mnemonic can help to identify the failed engine:

"Dead foot - dead engine"

This means that, once directional control is re-established, the pilot can feel the control force on the foot pushing the rudder-pedal on the side of the operative engine, while the foot on the side of the failed engine feels no force. Further, the engine instruments can help to analyze the situation.

3.5.2 ENGINE TROUBLESHOOTING

WARNING

Control over the flight attitude has priority over attempts to solve the current problem ("first fly the aircraft").

NOTE

With respect to handling and performance, the left-hand engine (pilots view) is considered the "critical" engine.

Depending on the situation the following attempts can be made to restore engine power prior to securing the engine:

CAUTION

Once the engine has been shut down for longer than 30 seconds, it can only be restarted below 8000 ft (TAE 125-02-99 engine) or 6000 ft (TAE 125-01 engine) pressure altitude. Proceed in accordance with 3.5.4 - UNFEATHERING & RESTARTING THE ENGINE IN FLIGHT.

- 1. POWER lever IDLE

NOTE

If the loss of power was due to unintentional setting of the power lever, you may adjust the friction lock and continue your flight.

- 2. If in icing conditions alternate air ON

CONTINUED

Doc. No. 7.01.05-E	Rev. 5 15-Nov-2007	Page 3 - 21
--------------------	-------------------------	-------------

3. Fuel quantity check

NOTE

In case of low fuel quantity in the affected engine's fuel tank you may feed it from the other engine's fuel tank by setting the affected engine's fuel selector to CROSSFEED.

4. Fuel selector check ON / CROSSFEED if required

NOTE

If the loss of power was due to unintentional setting of the fuel selector to the OFF position you may continue your flight but have the proper function of the restrainer locks checked prior to next flight.

5. ECU SWAP ECU B

NOTE

If the swap to ECU B has restored engine power land as soon as possible. If selecting ECU B does not solve the problem, switch back to AUTOMATIC in order to maintain the engine control system redundancy.

6. Circuit breakers check / reset if necessary

CONTINUED

Page 3 - 22	Rev. 5	15-Nov-2007	Doc. No. 7.01.05-E
-------------	--------	-------------	--------------------

NOTE

If resetting the circuit breakers has restored engine power
land as soon as possible.

If the engine power could not be restored by following the procedure of this section prepare
for 3.5.6 - ENGINE FAILURES IN FLIGHT and land as soon as possible.

END OF CHECKLIST

3.5.3 ENGINE SECURING (FEATHERING) PROCEDURE

Depending on the situation attempts can be made to restore engine power prior to securing the engine (see Section 3.5.2 - ENGINE TROUBLESHOOTING).

Shut down and feathering of the affected engine:

1. Inoperative engine identify & verify
2. ENGINE MASTER inoperative engine OFF

CAUTION

Do not shut down an engine with the fuel selector valve. The high pressure fuel pump can otherwise be damaged.

Securing the feathered engine:

3. Alternator inoperative engine OFF
4. Fuel selector inoperative engine OFF

NOTE

The remaining fuel in the tank of the failed engine can be used for the remaining engine, to extend range and maintain lateral balance, by setting its fuel selector in the CROSSFEED position.

If one of the power levers is set to low settings the landing gear warning horn is activated. Set the power lever of the secured engine forward as required to mute the warning horn.

END OF CHECKLIST

3.5.4 UNFEATHERING & RESTARTING THE ENGINE IN FLIGHT

| *If TAE 125-01 engines are installed:*

NOTE

Restarting the engine in flight is possible at altitudes below 6000 ft pressure altitude.

- 1. Airspeed 80 KIAS to 120 KIAS
- 2. POWER lever affected engine IDLE
- 3. FUEL SELECTOR affected engine check ON
- 4. ALTERNATE AIR as required
- |** 5. Alternator ON
- 6. ENGINE MASTER affected engine ON

CAUTION

The propeller starts windmilling at airspeeds of 80 KIAS and above. To avoid propeller overspeeds shortly after unfeathering and restarting maintain airspeeds below 120 KIAS.

- 7. Starter affected engine engage / if propeller does not start windmilling by itself

CAUTION

Do not engage the starter if the propeller is windmilling! This might damage the starter.

CONTINUED

Doc. No. 7.01.05-E	Rev. 5 15-Nov-2007	Page 3 - 25
--------------------	-------------------------	-------------

In case of a failed restart you may, depending on the situation, proceed with 3.5.2 - ENGINE TROUBLESHOOTING.

CAUTION

After the engine has started, the Power lever should be set to a moderate power setting, until engine temperatures have reached the green range.

END OF CHECKLIST

If TAE 125-02-99 engines are installed (MÄM 42-198 carried out):

NOTE

Restarting the engine in flight is possible at altitudes below 8000 ft pressure altitude. Above 8000 ft pressure altitude restart in flight has not been demonstrated.

- 1. Airspeed 110 KIAS to 120 KIAS
- 2. POWER lever affected engine IDLE
- 3. FUEL SELECTOR affected engine check ON
- 4. ALTERNATE AIR as required
- 5. Alternator ON
- 6. ENGINE MASTER affected engine ON

CAUTION

The propeller starts windmilling at airspeeds of 110 KIAS and above. To avoid propeller overspeeds shortly after unfeathering and restarting maintain airspeeds below 120 KIAS.

- 7. Starter affected engine engage / if propeller does not start windmilling by itself

CAUTION

Do not engage the starter if the propeller is windmilling! This might damage the starter.

CONTINUED

█ In case of a failed restart you may, depending on the situation, proceed with 3.5.2 -
█ ENGINE TROUBLESHOOTING.

█
█
█ **CAUTION**

█ After the engine has started, the power lever should be set
█ to a moderate power setting, until engine temperatures have
█ reached the green range.

█
█
█ **END OF CHECKLIST**

3.5.5 ENGINE FAILURE DURING TAKE-OFF

a) Engine failure during ground roll

- abort take-off

1. POWER lever IDLE / BOTH
2. Rudder maintain directional control
3. Brakes as required

CAUTION

If sufficient time is remaining, the risk of fire in the event of a collision with obstacles can be reduced as follows:

4. ENGINE MASTER both OFF
5. FUEL SELECTOR both OFF
6. ELECT. MASTER OFF

END OF CHECKLIST

b) Engine Failure after lift off

If landing gear is still extended and the remaining runway / surface is adequate:

- abort the take-off & land straight ahead, turning to avoid obstacles

If the remaining runway / surface is inadequate:

- decide whether to abort or to continue the take-off

Continued take-off:

WARNING

A continued take-off is not recommended if the steady rate of climb according to Section 5.3.9 - ONE ENGINE INOPERATIVE CLIMB performance is less than 3.3 %. Under certain combinations of ambient conditions, such as turbulence, crosswinds and wind shear as well as pilot skill the resulting climb performance may nevertheless be insufficient to continue the take-off successfully. Therefore a continued take-off with a failed engine has to be avoided if at all possible.

1. Power lever MAX
2. Rudder maintain directional control
3. Airspeed $V_{YSE} = 82$ KIAS / as required
4. Landing Gear UP to achieve a positive ROC
5. FLAPS check UP

CONTINUED

Page 3 - 30	Rev. 5	15-Nov-2007	Doc. No. 7.01.05-E
-------------	--------	-------------	--------------------

- 6. Inoperative engine secure according to
3.5.3 - ENGINE SECURING
(FEATHERING) PROCEDURE

Continue according to Section 3.5.9 - FLIGHT WITH ONE ENGINE INOPERATIVE and land as soon as possible according to 3.5.7 - LANDING WITH ONE ENGINE INOPERATIVE.

If the situation allows, you may climb to a safe altitude for troubleshooting (3.5.2 - ENGINE TROUBLESHOOTING) in order to try to restore engine power.

END OF CHECKLIST

3.5.6 ENGINE FAILURES IN FLIGHT

(a) Engine Failure during Initial Climb at Airspeeds below $v_{mCA} = 68$ KIAS

WARNING

As the climb is a flight condition which is associated with high power settings, airspeeds lower than $v_{mCA} = 68$ KIAS should be avoided as a sudden engine failure can lead to loss of control. In this case it is very important to reduce the asymmetry in thrust to regain directional control.

1. Rudder apply for directional control
2. Power levers retard as required to maintain directional control
3. Airspeed $v_{YSE} = 82$ KIAS /
above $v_{mCA} = 68$ KIAS as required
4. Operative engine increase power as required if directional control has been re-established

Establish minimum / zero sideslip condition (approx. half ball towards good engine; 3° to 5° bank).

5. Inoperative engine Secure according to 3.5.3 -
ENGINE SECURING
(FEATHERING) PROCEDURE

Continue according to Section 3.5.9 - FLIGHT WITH ONE ENGINE INOPERATIVE and land as soon as possible according to Section 3.5.7 - LANDING WITH ONE ENGINE INOPERATIVE.

If the situation allows, you may climb to a safe altitude for troubleshooting (3.5.2 - ENGINE TROUBLESHOOTING) in order to try to restore engine power.

END OF CHECKLIST

Page 3 - 32	Rev. 5	15-Nov-2007	Doc. No. 7.01.05-E
-------------	--------	-------------	--------------------

(b) Engine Failure during Initial Climb at Airspeeds above $v_{mCA} = 68$ KIAS

1. Rudder maintain directional control
2. Airspeed $v_{YSE} = 82$ KIAS/
above $v_{mCA} = 68$ KIAS as required
3. Operative engine increase power as required if
directional control has been
established

Establish minimum / zero sideslip condition (approx. half ball towards good engine; 3° to 5° bank).

4. Inoperative engine Secure according to 3.5.3 -
ENGINE SECURING
(FEATHERING) PROCEDURE

Continue according to Section 3.5.9 - FLIGHT WITH ONE ENGINE INOPERATIVE and land as soon as possible according to Section 3.5.7 - LANDING WITH ONE ENGINE INOPERATIVE.

If the situation allows, you may climb to a safe altitude for troubleshooting (3.5.2 - ENGINE TROUBLESHOOTING) in order to try to restore engine power.

END OF CHECKLIST

(c) Engine Failure during Flight

1. Rudder maintain directional control
2. Airspeed as required /
above $v_{mCA} = 68$ KIAS
3. Operative engine increase power as required if
directional control has been
established

Establish minimum / zero sideslip condition. (approx. half ball towards good engine; 3° to 5° bank)

4. Inoperative engine Secure according to 3.5.3 -
ENGINE SECURING
(FEATHERING) PROCEDURE

Continue according to Section 3.5.9 - FLIGHT WITH ONE ENGINE INOPERATIVE and land as soon as possible according to Section 3.5.7 - LANDING WITH ONE ENGINE INOPERATIVE.

If the situation allows, you may climb to a safe altitude for troubleshooting (3.5.2 - ENGINE TROUBLESHOOTING) in order to try to restore engine power.

END OF CHECKLIST

3.5.7 LANDING WITH ONE ENGINE INOPERATIVE

Preparation:

WARNING

For emergency landing the adjustable backrests (if installed) must be fixed in the upright position.

- 1. Adjustable backrests (if installed) adjust to the upright position described by a placard on the roll-over bar and verify proper fixation
- 2. Safety harnesses check fastened & tightened
- 3. Landing light as required
- 4. Gear warning horn check function

Operative engine:

- 5. Fuel Selector check ON / CROSSFEED as required

Inoperative engine:

- 6. Engine check secured (feathered) according to 3.5.3 - ENGINE SECURING (FEATHERING) PROCEDURE

CONTINUED

not before being certain of "making the field":

- 7. Airspeed reduce to operate landing gear
- 8. Landing Gear DOWN, check 3 green
- 9. Trim as required
- 10. Airspeed reduce as required
- 11. FLAPS as required
- 12. Final approach speed
 - at 1700 kg (3748 lb) 85 KIAS (v_{REF} /FLAPS UP)
82 KIAS (v_{REF} /FLAPS APP)
76 KIAS (v_{REF} /FLAPS LDG)
 - at 1785 kg (3935 lb) 86 KIAS (v_{REF} /FLAPS UP)
82 KIAS (v_{REF} /FLAPS APP)
78 KIAS (v_{REF} /FLAPS LDG)

WARNING

One-engine inoperative approaches for landing with flap settings of more than flaps UP are not recommended unless a safe landing is assured („Making the field“). Higher flap settings increase the loss of altitude during the transition to a one engine inoperative go-around / balked landing.

- 13. POWER lever as required
- 14. Trim as required / directional trim to neutral

CONTINUED

NOTE

Higher approach speeds result in a significantly longer landing distance during flare.

CAUTION

In conditions such as (e.g.) strong wind, danger of wind shear or turbulence a higher approach speed should be selected.

- Perform normal touchdown and deceleration on ground.

CONTINUED

If the approach to land is not successful you may consider:

3.5.8 GO-AROUND / BALKED LANDING WITH ONE ENGINE INOPERATIVE

CAUTION

The go-around / balked landing is not recommended to be initiated below a minimum of 800 ft above ground.

For performance data with one engine inoperative and flaps and gear UP refer to 5.3.9 - ONE ENGINE INOPERATIVE CLIMB PERFORMANCE.

Under certain combinations of ambient conditions, such as turbulence, cross wind and windshear, as well as pilot skill, the resulting climb performance may nevertheless be insufficient for a successful go-around / balked landing.

- 15. POWER lever MAX / as required
- 16. Rudder maintain directional control
- 17. Airspeed $V_{YSE} = 82$ KIAS / as required
- 18. Landing Gear UP / retract
- 19. FLAPS UP

- Establish minimum sideslip and manoeuvre for a new attempt to land. Repeat from step 1 of this section.

CONTINUED

If a positive rate of climb cannot be established:

- Land so as to keep clear of obstacles with the landing gear extended.

If time allows the following steps can reduce the risk of fire in an event of collision with obstacles after touchdown:

- 20. ENGINE MASTER both OFF
- 21. FUEL SELECTOR both OFF
- 22. ELECT. MASTER OFF

END OF CHECKLIST

3.5.9 FLIGHT WITH ONE ENGINE INOPERATIVE

CAUTION

Even if a positive flight performance can be established with one engine inoperative, land as soon as practicable at the next suitable airfield / airport.

1. Airspeed above $v_{mCA} = 68$ KIAS to maintain directional control
2. Remaining engine monitor engine instruments continuously
3. Fuel quantity monitor continuously
4. FUEL SELECTOR Remaining engine / set CROSSFEED or ON so as to keep fuel quantity laterally balanced

NOTE

If the Fuel Selector is set on CROSSFEED, the engine will be supplied with fuel from the main tank on the opposite side.

This will extend range and helps to keep the wings laterally balanced (see 2.14 FUEL).

Land as soon as possible according to Section 3.5.7 - LANDING WITH ONE ENGINE INOPERATIVE.

If the situation allows, you may climb to a safe altitude for troubleshooting (3.5.2 - ENGINE TROUBLESHOOTING) in order to try to restore engine power.

END OF CHECKLIST

Page 3 - 40	Rev. 5	15-Nov-2007	Doc. No. 7.01.05-E
-------------	--------	-------------	--------------------

3.6 LANDING GEAR SYSTEM FAILURES

3.6.1 LANDING GEAR UNSAFE WARNING

NOTE

The landing gear unsafe warning light illuminates if the landing gear is neither in the final up or down & locked position. Illumination of this light is therefore normal during transit.

If the light remains on for longer than 20 seconds during landing gear retraction / extension:

1. Airspeed check below v_{LOR} 156 KIAS
2. Gear selector re-cycle if continued illumination occurs

If the landing gear cannot be extended to the down & locked position or red light does not extinguish:

- Continue with 3.6.2 - MANUAL EXTENSION OF THE LANDING GEAR.

CONTINUED

NOTE

If the landing gear cannot be retracted to the final up position you may continue the flight with the landing gear extended in the down & locked position. Consider for higher aerodynamic drag, resulting in degraded flight performance, increased fuel consumption and decreased range.

With the landing gear extended and at aft CG-locations, with flaps up and full power applied, the aircraft will easily recover from sideslip if the trim is set to neutral (normal procedure). Otherwise it may require corrective action with a moderate amount of rudder input.

In cold ambient temperatures it may help to reduce the airspeed below 110 KIAS for landing gear operation.

END OF CHECKLIST

3.6.2 MANUAL EXTENSION OF THE LANDING GEAR

NOTE

In case of a failure of the electrical pump, which is driving the landing gear actuators, the landing gear can be extended manually at speeds up to 156 KIAS. The manual extension of the landing gear may take up to 20 seconds.

The following checks shall be completed before extending the landing gear manually:

1. Gear indicator lights test / push test button
2. ELECT. MASTER check ON
3. Bus voltage check in normal range
4. Circuit breaker check in / reset if necessary

CONTINUED

Manual landing gear extension procedure:

5. Gear selector select DOWN
6. Manual gear extension handle pull out

NOTE

The landing gear should now extend by gravity and relief of hydraulic pressure from the system. If one or more landing gear indicator lights do not indicate the gear down & locked after completion of the manual extension procedure steps 1 - 6 reduce airspeed below 110 KIAS and apply moderate yawing and pitching to bring the landing gear into the locked position.

7. Gear indicator lights check 3 green lights

NOTE

If the landing gear is correctly extended and locked, as indicated by the 3 green lights, the red light is illuminated additionally if the GEAR circuit breaker is pulled.

If the landing gear cannot be extended to the down & locked position continue according to 3.6.3 - LANDING WITH GEAR UP.

END OF CHECKLIST

3.6.3 LANDING WITH GEAR UP

NOTE

This procedure applies if the landing gear is completely retracted.

- 1. Approach with power at normal approach
airspeeds and flap settings
- 2. POWER lever IDLE / just before
touchdown

If the time / situation allows, the following steps can help to reduce the risk of fire:

- 3. ENGINE MASTER both OFF
- 4. FUEL SELECTOR both OFF
- 5. ELECT. MASTER OFF

Touchdown:

- 6. Touchdown Contact surface with minimum
airspeed
- 7. On ground Maintain directional control with
rudder as long as possible so as
to avoid collision with obstacles

END OF CHECKLIST

3.6.4 LANDING WITH A DEFECTIVE TIRE ON THE MAIN LANDING GEAR

CAUTION

A defective (e.g. burst) tire is not usually easy to detect. The damage normally occurs during take-off or landing, and is hardly noticeable during fast taxiing. It is only during the roll-out after landing or at lower taxiing speeds that a tendency to swerve occurs. Rapid and determined action is then required.

1. Advise ATC.
2. Land the airplane at the edge of the runway that is located on the side of the intact tire, so that changes in direction which must be expected during roll-out due to the braking action of the defective tire can be corrected on the runway.
3. Land with one wing low. The wing on the side of the intact tire should be held low.
4. Direction should be maintained using the rudder. This should be supported by use of the brake. It is possible that the brake must be applied strongly - if necessary to the point where the wheel locks. The wide track of the landing gear will prevent the airplane from tipping over a wide speed range. There is no pronounced tendency to tip even when skidding.

END OF CHECKLIST

3.6.5 LANDING WITH DEFECTIVE BRAKES

Consider the greater rolling distance.

Safety harness check fastened and tightened

CAUTION

If sufficient time is remaining, the risk of fire in the event of a collision can be reduced as follows after a safe touch-down:

- ENGINE MASTER both OFF
- FUEL SELECTOR both OFF
- ELECT. MASTER OFF

END OF CHECKLIST

3.7 FAILURES IN THE ELECTRICAL SYSTEM

3.7.1 COMPLETE FAILURE OF THE ELECTRICAL SYSTEM

1. Circuit breakers check if all OK (pressed in)

if there is still no electrical power available:

2. EMERGENCY SWITCH ON
3. Flood light, if necessary ON
4. POWER set based on lever positions
and engine noise
5. Prepare landing with flaps in the given position. Refer to 4B.5 - FAILURES IN
FLAP OPERATING SYSTEM.
6. Land on the nearest suitable airfield.

WARNING

Engine stoppage may occur, depending on the failure mode.

NOTE

The landing gear uplock is no longer ensured. The landing gear may slowly extend.

The landing gear can be extended manually according to 3.6.2 - MANUAL EXTENSION OF THE LANDING GEAR.

NOTE

The backup artificial horizon and the flood light will have electrical power for at least 1.5 hours.

Make use of the stand-by airspeed indicator and altimeter. Engine power can be set via visual reference of the power lever position.

END OF CHECKLIST

Page 3 - 48	Rev. 5	15-Nov-2007	Doc. No. 7.01.05-E
-------------	--------	-------------	--------------------

3.7.2 HIGH CURRENT

If high current is indicated on the G1000:

1. Circuit breakers check
2. Reduce electric load to minimum required for continued safe flight.
3. Land on the nearest suitable airfield.

END OF CHECKLIST

3.7.3 STARTER MALFUNCTION

If the starter does not disengage from the engine after starting (starter engaged warning (STARTER ENGD) on the G1000 annunciator field illuminates after the engine has started):

1. POWER lever affected engine IDLE
2. ENGINE MASTER affected engine OFF
3. ELECT. MASTER OFF

Terminate flight preparation!

END OF CHECKLIST

3.8 SMOKE AND FIRE

3.8.1 ENGINE FIRE ON GROUND

1. ENGINE MASTER both OFF
2. FUEL SELECTOR both OFF
3. ELECT. MASTER OFF

after standstill:

4. Canopy open
5. Airplane evacuate immediately

END OF CHECKLIST

3.8.2 ENGINE FIRE DURING TAKE-OFF

Proceed according to 3.5.5 - ENGINE FAILURES DURING TAKE-OFF.

1. Cabin heat & Defrost OFF

CAUTION

In case of extreme smoke development, the front canopy may be unlatched during flight. This allows it to partially open, in order to improve ventilation. The canopy will remain open in this position. Flight characteristics will not be affected significantly.

END OF CHECKLIST

3.8.3 ENGINE FIRE IN FLIGHT

1. Cabin heat & Defrost OFF

Proceed according to 3.5.6 - ENGINE FAILURES IN FLIGHT and shut down the engine according to 3.5.3 - ENGINE SECURING (FEATHERING) PROCEDURE.

CAUTION

In case of extreme smoke development, the front canopy may be unlatched during flight. This allows it to partially open, in order to improve ventilation. The canopy will remain open in this position. Flight characteristics will not be affected significantly.

END OF CHECKLIST

3.8.4 ELECTRICAL FIRE ON GROUND

1. ELECT. MASTER OFF

if the engine is running:

2. POWER lever both IDLE
3. ENGINE MASTER both OFF
4. FUEL SELECTOR both OFF

when the engine has stopped / after standstill:

5. Canopy open
6. Airplane evacuate immediately

END OF CHECKLIST

3.8.5 ELECTRICAL FIRE IN FLIGHT

1. EMERGENCY SWITCH ON, if installed
2. AVIONIC MASTER OFF
3. ELECT. MASTER OFF
4. Cabin heat & Defrost OFF
5. Emergency windows open if required
6. Land at the next suitable airfield

CAUTION

Switching OFF the ELECTRIC MASTER will lead to total failure of all electronic and electric equipment. The attitude and heading reference system (AHRS) will also be affected.

However, by switching the EMERGENCY switch ON, the emergency battery will supply power to the standby attitude gyro (artificial horizon) and the flood light.

In case of extreme smoke development, the front canopy may be unlatched during flight. This allows it to be partially opened, in order to improve ventilation. The canopy will remain open in this position. Flight characteristics will not be affected significantly.

The maximum demonstrated airspeed for emergency opening the front canopy in flight is 120 KIAS. Do not exceed 120 KIAS.

END OF CHECKLIST

3.9 OTHER EMERGENCIES

3.9.1 SUSPICION OF CARBON MONOXIDE CONTAMINATION IN THE CABIN

Carbon monoxide (CO) is a gas which is developed during the combustion process. It is poisonous and without smell. Increased concentration of carbon monoxide gas can be fatal. The occurrence of CO in the cabin is possible only due to a defect. If a smell similar to exhaust gases is noticed in the cabin, the following measures should be taken:

1. Cabin heat & Defrost OFF
2. Ventilation open
3. Emergency windows open
4. Forward canopy unlatch, push up and lock in
"cooling-gap" position

CAUTION

The maximum demonstrated airspeed for emergency opening the front canopy in flight is 120 KIAS. Do not exceed 120 KIAS.

END OF CHECKLIST

3.9.2 UNLOCKED DOORS

1. Airspeed reduce
2. Canopy check visually if closed
3. Rear passenger door check visually if closed
4. Front baggage doors check visually if closed

WARNING

Never unlock the rear passenger door during flight. It may break away.

5. If it is not possible to lock the canopy or the rear passenger door, or if one or both of the front baggage doors are open, land on the nearest suitable airfield.

END OF CHECKLIST

3.9.3 DEFECTIVE PROPELLER RPM REGULATING SYSTEM

CAUTION

The power lever should be moved slowly, in order to avoid over-speeding and excessively rapid RPM changes. The light wooden propeller blades produce more rapid RPM changes than metal blades.

WARNING

In case of a malfunction of the engine control unit it is possible that the propeller blades will remain in the position of highest pitch. In this case the reduced engine performance should be taken into consideration.

(a) Oscillating RPM

1. POWER setting change

if the problem does not clear:

2. ECU SWAP ECU B

NOTE

If the problem does not clear itself, switch back to AUTO and land on the nearest suitable airfield.

CONTINUED

Page 3 - 56	Rev. 5	15-Nov-2007	Doc. No. 7.01.05-E
-------------	--------	-------------	--------------------

(b) Propeller overspeed

NOTE

This procedure applies for continued propeller overspeed due to a malfunction in the propeller constant speed unit or a engine control unit malfunction.

- 1. POWER setting reduce as required

if the problem does not clear:

- 2. ECU SWAP ECU B

CAUTION

If the problem does not clear itself, switch back to AUTO and land on the nearest suitable airfield. Prepare for engine malfunction according to 3.5.6 - ENGINE FAILURES IN FLIGHT.

END OF CHECKLIST

3.9.4 UNINTENTIONAL FLIGHT INTO ICING

1. Leave the icing area (by changing altitude or turning back, in order to reach zones with a higher ambient temperature).
2. PITOT HEAT ON
3. Cabin heat & Defrost ON
4. POWER lever increase power, in order to prevent ice build up on the propeller blades, apply power changes periodically.
5. ALTERNATE AIR OPEN
6. Emergency windows open if required

CAUTION

Ice build-up increases the stalling speed.

7. ATC advise if an emergency is expected

CAUTION

If the Pitot heating fails:

- Alternate static valve OPEN
- Emergency windows close

END OF CHECKLIST

3.9.5 FUEL SUPPLY FAILURE

1. FUEL SELECTOR CROSSFEED /
affected engine

WARNING

When the high pressure fuel pump of the engine takes in air
an inspection of the pump is necessary prior to next flight.

2. Fuel quantity monitor

END OF CHECKLIST

3.9.6 RECOVERY FROM AN UNINTENTIONAL SPIN

CAUTION

Spin recovery has NOT been shown during certification as it is NOT required for this airplane category. The given recovery method is based on general experience!

CAUTION

Intentional spins are prohibited in this airplane. In the event a spin is encountered unintentionally, immediate recovery actions must be taken.

Single-engine stalling is not permitted.

CAUTION

Steps 1 to 4 must be carried out **immediately** and **simultaneously**.

1. POWER lever IDLE
2. Rudder full deflection against
direction of spin
3. Elevator (control stick) fully forward
4. Ailerons neutral
5. FLAPS UP

CONTINUED

when rotation has stopped:

6. Rudder neutral
7. Elevator (control stick) pull carefully
8. Return the airplane from a descending into a normal flight attitude. Do not exceed the 'never exceed speed', $v_{NE} = 194$ KIAS.

END OF CHECKLIST

3.9.7 EMERGENCY DESCENT

1. FLAPS UP
2. Gear DOWN
3. POWER lever IDLE
4. Airspeed as required

WARNING

Max. structural cruising speed $V_{NO} = 155$ KIAS.

Never exceed speed in smooth air $V_{NE} = 194$ KIAS.

END OF CHECKLIST

3.9.8 EMERGENCY EXIT

In case of a roll over of the airplane on ground, the rear side door can be used as exit. For this purpose unlock the front hinge of the rear side door. The function is displayed on a placard beside the hinge.

CHAPTER 4A

NORMAL OPERATING PROCEDURES

	Page
4A.1 INTRODUCTION	4A-3
4A.2 AIRSPEEDS FOR NORMAL OPERATING PROCEDURES	4A-3
4A.3 ADVISORY ALERTS ON THE G1000	4A-5
4A.3.1 ADVISORY/GENERAL	4A-5
4A.3.2 L/R GLOW ON	4A-5
4A.3.3 L/R FUEL XFER	4A-5
4A.3.4 PFD/MFD/GIA FAN FAIL	4A-5
4A.4 FLIGHT CHARACTERISTICS	4A-6
4A.5 DAILY CHECK	4A-7
4A.6 CHECKLISTS FOR NORMAL OPERATING PROCEDURES ...	4A-7
4A.6.1 PRE-FLIGHT INSPECTION	4A-7
4A.6.2 BEFORE STARTING ENGINE	4A-19
4A.6.3 STARTING ENGINE	4A-22
4A.6.4 BEFORE TAXIING	4A-24
4A.6.5 TAXIING	4A-25
4A.6.6 BEFORE TAKE-OFF	4A-26
4A.6.7 TAKE-OFF	4A-31
4A.6.8 CLIMB	4A-33
4A.6.9 CRUISE	4A-34
4A.6.10 DESCENT	4A-35
4A.6.11 APPROACH & LANDING	4A-36
4A.6.12 GO AROUND	4A-38

4A.6.13 AFTER LANDING	4A-38
4A.6.14 SHUT-DOWN	4A-39
4A.6.15 EXIT AIRPLANE	4A-40
4A.6.16 POST FLIGHT INSPECTION	4A-40
4A.6.17 PARKING	4A-40
4A.6.18 FLIGHT IN RAIN	4A-41
4A.6.19 REFUELING	4A-41
4A.6.20 FLIGHT AT HIGH ALTITUDE	4A-42

4A.1 INTRODUCTION

Chapter 4A contains checklists and describes procedures for the normal operation of the airplane.

NOTE

Readability of the G1000 PFD and MFD displays may be degraded when wearing polarized sunglasses.

4A.2 AIRSPEEDS FOR NORMAL OPERATING PROCEDURES

	FLAPS	up to 1700 kg	above 1700 kg¹ (above 3748 lb)
Airspeed for rotation (take-off run, v_R)	UP	min. 70 KIAS	min. 72 KIAS
Airspeed for take-off climb (best rate-of-climb speed v_Y)	UP	min. 77 KIAS	min. 79 KIAS
Airspeed for best angle of climb ²	UP	77 KIAS	79 KIAS
Airspeed for cruise climb	UP	min. 85 KIAS	min. 86 KIAS
Reference landing approach speed	UP	85 KIAS	86 KIAS
	APP	min. 82 KIAS	82 KIAS
Final approach speed	LDG	min. 76 KIAS	min. 78 KIAS
Minimum speed during go around	UP	min. 82 KIAS	min. 82 KIAS
Max. structural cruising speed Do not exceed this speed except in smooth air, and then only with caution.	UP	155 KIAS	155 KIAS

^{1), 2)} see NOTES on next page

NOTE

If MÄM 42-088 is carried out, a landing with a mass between 1700 kg (3748 lb) and 1785 kg (3935 lb) is admissible. It constitutes an abnormal operating procedure. A "Hard Landing Check" is only required after a hard landing, regardless of the actual landing mass.

NOTE

v_x is always less than v_y . For the DA 42 however, the actual value of v_x would be below the minimum safe speed. The minimum airspeed for best angle of climb was therefore raised to the value of v_y .

4A.3 ADVISORY ALERTS ON THE G1000

The G1000 provides the following advisory-alerts on the PFD in the alert area:

4A.3.1 ADVISORY/GENERAL

CHARACTERISTICS	White color coded text
------------------------	------------------------

4A.3.2 L/R GLOW ON

L/R GLOW ON	Left / Right engine glow plug active
--------------------	--------------------------------------

4A.3.3 L/R FUEL XFER

L/R FUEL XFER	Fuel transfer from auxiliary to main tank is in progress (if aux. tanks are installed)
----------------------	--

4A.3.4 PFD/MFD/GIA FAN FAIL

PFD FAN FAIL	Cooling Fan for the PFD is inoperative
MFD FAN FAIL	Cooling Fan for the MFD is inoperative
GIA FAN FAIL	Cooling Fan for the GIA is inoperative

The flight may be continued, but maintenance action is required after landing.

Doc. No. 7.01.05-E	Rev. 5	15-Nov-2007	Page 4A - 5
--------------------	--------	-------------	-------------

4A.4 FLIGHT CHARACTERISTICS

The DA 42 is to be flown with "the feet on the pedals", meaning that coordinated flight in all phases and configurations shall be supported by dedicated use of the rudder and ailerons together.

With the landing gear extended and at aft CG-locations, with flaps up and full power applied, the airplane will easily recover from sideslip if the trim is set to neutral (normal procedure), otherwise it may require corrective action with a moderate amount of rudder input.

4A.5 DAILY CHECK

- Before the first flight of a day it must be ensured that the following checks are performed.
- * On-condition check of the canopy, the side door and the baggage compartment doors for cracks and major scratches.
 - * On-condition check of the hinges for the canopy, the side door and the baggage compartment doors.
 - * Visual inspection of the locking bolts for proper movement with no backlash.
 - * Tire inflation pressure check (main wheels: 4.5 bar/65 psi, nose wheel: 6.0 bar/87 psi).
 - * Visual inspection of both spinners and their attachment.
 - * If OÄM 42-077 (Removable Fuselage Nose Cone) is implemented:
Check fuselage nose cone for improper fit and loose attachment screws.

4A.6 CHECKLISTS FOR NORMAL OPERATING PROCEDURES

4A.6.1 PRE-FLIGHT INSPECTION

I. Cabin check

Preparation:

- a) Parking brake set ON
- b) MET, NAV, Mass and Balance flight planning completed
- c) Airplane documents complete and up to date
- d) Front canopy and rear door clean, undamaged,
check locking mechanism
function
- e) Baggage stowed and secured
- f) Foreign objects check

CONTINUED

Center console:

- a) FUEL SELECTOR check ON
- b) POWER Lever check condition, freedom of movement and full travel/
adjust friction, set IDLE

Below instrument panel in front of left seat:

- a) ALTERNATE STATIC SOURCE check CLOSED
- b) MANUAL GEAR EXTENSION HANDLE ... check pushed in
- c) ALTERNATE AIR check CLOSED

On the instrument panel:

- a) ALTERNATOR check ON
- b) ECU SWAP check AUTOMATIC
- c) PITOT HEAT check OFF
- d) ENGINE MASTER check both OFF
- e) START KEY check key is pulled out
- f) ELECT. MASTER check OFF
- g) AVIONIC MASTER check OFF
- h) GEAR SELECTOR check DOWN
- i) FLAP SELECTOR check UP
- j) Circuit breakers set in (if one has been pulled,
check reason)
- k) All electrical equipment OFF
- l) EMERGENCY SWITCH check OFF and guarded
- m) ELT armed

CONTINUED

Page 4A - 8	Rev. 5	15-Nov-2007	Doc. No. 7.01.05-E
-------------	--------	-------------	--------------------

Check procedure:

- a) ELECT. MASTER ON

CAUTION

When switching the ELECT. MASTER ON, the electrically driven hydraulic gear pump may activate itself for 5 to 20 seconds in order to restore the system pressure. Should the pump continue to operate continuously or periodically, terminate flight. There is a malfunction in the landing gear system.

- b) Fuel quantity check indication, verify using alternate means (see Section 7.9.5)
- c) Position lights, strobe lights (ACL) check for correct function

CAUTION

Do not look directly into the anti collision lights.

- d) Landing/Taxi light check for correct function
- e) Stall warning/stall heat/Pitot heat check

NOTE



The stall warning switch gets slightly warmer on ground only and STAL HT FAIL is indicated on the PFD.

CONTINUED

Doc. No. 7.01.05-E	Rev. 5 15-Nov-2007	Page 4A - 9
--------------------	-------------------------	-------------

- f) Gear warning/
Fire detector TEST BUTTON PUSH, check aural alert/fire
detection warning and aural alert
and CHECK GEAR caution (if
installed)

CAUTION

If the aural alert or the warning on the PFD does not appear,
terminate flight. Unscheduled maintenance is necessary.

- g) Control stick pull fully aft/hold at backstop
h) FLAPS set LDG position
i) POWER Lever set MAX
j) Variable elevator backstop check function/control stick must
move slightly forward during power
lever forward movement
k) POWER Lever set IDLE
l) Variable elevator backstop check function/control stick must
regain full movement during power
lever retraction
m) FLAPS set UP position

CAUTION

The proper function of the variable elevator backstop is
indispensable for the safety of flight, as the handling qualities
during power-on stalls are degraded significantly. For more
details see Chapter 7- AIRPLANE DESCRIPTION AND
SYSTEMS.

If the variable elevator backstop does not function properly,
terminate flight.

CONTINUED

Page 4A - 10	Rev. 5	15-Nov-2007	Doc. No. 7.01.05-E
--------------	--------	-------------	--------------------

- n) ELECT. MASTER OFF
- o) Flight controls check free and correct movement
up to full deflection
- p) Trims check free and correct movement
up to full deflection

END OF CHECKLIST

II. Walk-around check, visual inspection

CAUTION

A visual inspection means: examination for damage, cracks, delamination, excessive play, load transmission, correct attachment and general condition. In addition control surfaces should be checked for freedom of movement.

CAUTION

In low ambient temperatures the airplane must be completely cleared of ice, snow and similar accumulations. For approved de-icing fluids refer to Section 8.7 - GROUND DE-ICING.

CAUTION

Prior to flight, remove such items as control surfaces gust lock, Pitot cover, tow bar, etc.

CONTINUED

Doc. No. 7.01.05-E	Rev. 5 15-Nov-2007	Page 4A - 11
--------------------	-------------------------	--------------

1. *Left main landing gear:*

- a) Landing gear strut and lock visual inspection, sufficient height
(typical visible length of bare
piston: at least 4 cm/1.6")
- b) Down and Uplock switches (3x) visual inspection
- c) Wear, tread depth of tire visual inspection
- d) Tire, wheel, brake visual inspection
- e) Brake line connection check for leaks
- f) Slip marks visual inspection
- g) Chocks remove
- h) Landing gear door visual inspection

2. *Left engine nacelle:*

- a) 3 air inlets / 2 air outlets clear
- b) Engine oil level check dipstick (inspection hole in
the upper cowling)
- c) Gearbox oil level check visually (inspection hole in
the lower cowling)
- d) Cowling visual inspection
- e) Gascolator / air inlet drain off to check for water and
sediment (drain until no water
comes out) / clear
- f) Venting pipe check for blockage
- g) Exhaust visual inspection

WARNING

The exhaust can cause burns when hot.

CONTINUED

Page 4A - 12	Rev. 5	15-Nov-2007	Doc. No. 7.01.05-E
--------------	--------	-------------	--------------------

- h) Propeller visual inspection

WARNING

Never move the propeller by hand while the ENGINE MASTER switch is ON! Also do not move the propeller by hand while the ENGINE MASTER is OFF immediately after operation (remaining pressure in the injection system rail). Serious personal injury may result.

- i) De-Icing boots on propeller (if OÄM 42-053 or/and OÄM 42-054 carried out) check for de-bonding
 - j) Nacelle underside check for excessive contamination particularly by oil, fuel, and other fluids
 - k) Auxiliary tank vent outlet on lower surface .. visual inspection
 - l) Auxiliary tank drain drain off to check for water and sediment (drain until no water comes out) / visual inspection
 - m) Auxiliary tank filler visual inspection, tank filler closed

3. *Left wing:*

- a) Entire wing surface visual inspection
- b) Tank air outlet on lower surface visual inspection
- c) Tank drain/tank air inlet drain off to check for water and sediment (drain until no water comes out) / visual inspection
- d) Openings on lower surface check for foreign objects and for traces of fuel (if tank is full, fuel may spill over through the tank vent)

CONTINUED

Doc. No. 7.01.05-E	Rev. 5 15-Nov-2007	Page 4A - 13
--------------------	-------------------------	--------------

- e) Stall warn device visual inspection
- f) Tank filler visual inspection, check closed
- g) Pitot probe clean, orifices clear, cover removed, no deformation
- h) Wing tip visual inspection
- i) Static dischargers visual inspection
- j) Position light, strobe light (ACL) visual inspection
- k) Tie-down check, clear
- l) Aileron and linkage visual inspection
- m) Aileron hinges and safety pin visual inspection
- n) Foreign objects in aileron paddle visual inspection
- o) Flap and linkage visual inspection
- p) Flap hinges and safety pin visual inspection
- q) Nacelle underside fuel cooler air in- & outlet . check clear
- r) Step visual inspection

4. Fuselage, left side, underside:

- a) Canopy, left side visual inspection
- b) Rear cabin door & window visual inspection
- c) Fuselage skin visual inspection
- d) Antennas visual inspection
- e) Fuselage check for contamination (hydraulic fluid)
- f) Autopilot static source (if installed) check for blockage

CONTINUED

Page 4A - 14	Rev. 5	15-Nov-2007	Doc. No. 7.01.05-E
--------------	--------	-------------	--------------------

5. *Empennage:*

- a) Stabilizers and control surfaces,
 elevator tips visual inspection
- b) Hinges visual inspection
- c) Elevator trim tab visual inspection, check safetying
- d) Rudder trim tab visual inspection, check safetying
- e) Tie-down check, clear
- f) Tail skid and lower fin visual inspection
- g) Static dischargers visual inspection

6. *Fuselage, right side:*

- a) Fuselage skin visual inspection
- b) Rear window visual inspection
- c) Canopy, right side visual inspection
- █ d) Autopilot static source (if installed) check for blockage

7. *Right Main Landing Gear:*

- a) Landing gear strut and lock visual inspection, sufficient height
(typical visible length of bare piston: at least 4 cm/1.6")
- b) Down and Uplock switches (3x) visual inspection
- c) Wear, tread depth of tire visual inspection
- d) Tire, wheel, brake visual inspection
- e) Brake line connection check for leaks
- f) Slip marks visual inspection
- g) Chocks remove
- h) Landing gear door visual inspection

CONTINUED

Doc. No. 7.01.05-E	Rev. 5 15-Nov-2007	Page 4A - 15
--------------------	-------------------------	--------------

8. *Right wing:*

- a) Entire wing surface visual inspection
- b) Tank air outlet on lower surface visual inspection
- c) Tank drain/tank air inlet drain off to check for water and sediment (drain until no water comes out) / visual inspection
- d) Openings on lower surface check for foreign objects and for traces of fuel (if tank is full, fuel may spill over through the tank vent)
- e) Tank filler visual inspection, check closed
- f) Wing tip visual inspection
- g) Static dischargers visual inspection
- h) Position light, strobe light (ACL) visual inspection
- i) Tie-down check, clear
- j) Aileron and linkage visual inspection
- k) Aileron hinges and safety pin visual inspection
- l) Foreign objects in aileron paddle visual inspection
- m) Flap and linkage visual inspection
- n) Flap hinges and safety pin visual inspection
- o) Nacelle underside fuel cooler air in- and outlet check clear
- p) Step visual inspection
- q) Cabin vent air inlet check clear

9. *Right engine nacelle:*

- a) 3 air inlets/2 air outlets clear
- b) Engine oil level check dipstick (inspection hole in the upper cowling)

CONTINUED

Page 4A - 16	Rev. 5	15-Nov-2007	Doc. No. 7.01.05-E
--------------	--------	-------------	--------------------

- c) Gearbox oil level check visually (inspection hole in the lower cowling)
- d) Cowling visual inspection
- e) Gascolator/air inlet drain off to check for water and sediment (drain until no water comes out) / clear
- f) Venting pipe check for blockage
- g) Exhaust visual inspection

WARNING

The exhaust can cause burns when hot.

- h) Propeller visual inspection

WARNING

Never move the propeller by hand while the ENGINE MASTER switch is ON! Also do not move the propeller by hand while the ENGINE MASTER is OFF immediately after operation (remaining pressure in the injection system rail). Serious personal injury may result.

- i) De-Icing boots on propeller (if OÄM 42-053 or/and OÄM 42-054 carried out) check for de-bonding
 - j) Nacelle underside check for excessive contamination particularly by oil, fuel, and other fluids
 - k) Auxiliary tank vent outlet on lower surface . . . visual inspection
 - l) Auxiliary tank drain drain off to check for water and sediment (drain until no water comes out) / visual inspection
 - m) Auxiliary tank filler visual inspection, tank filler closed

CONTINUED

Doc. No. 7.01.05-E	Rev. 5 15-Nov-2007	Page 4A - 17
--------------------	-------------------------	--------------

10. *Front fuselage and nose landing gear:*

- a) Left and right front baggage door visual inspection, closed and locked
- b) Nose landing gear strut visual inspection, sufficient height (typical visible length of bare piston: at least 15 cm/5.9")
- c) Down & Uplock switches visual inspection
- d) Wear, tread depth of tire check
- e) Slip marks visual inspection
- f) Gear door and linkage visual inspection
- g) Chocks remove
- h) OAT sensor check
- i) EPU connector check
- j) Tow bar remove

END OF CHECKLIST

4A.6.2 BEFORE STARTING ENGINE

- 1. Preflight inspection complete
- 2. Passengers instructed

NOTE

Ensure all the passengers have been fully briefed on the use of the seat belts, doors and emergency exits and the ban on smoking.

- 3. Rear door closed and locked

CAUTION

When operating the canopy, pilots/operators must ensure that there are no obstructions between the canopy and the mating frame, for example seat belts, clothing, etc. When operating the locking handle do NOT apply undue force.

A slight downward pressure on the canopy may be required to ease the handle operation.

- 4. Front canopy Position 1 or 2 (“cooling gap”)

WARNING



For take-off the adjustable backrests (if installed) must be fixed in the upright position.

CONTINUED

Doc. No. 7.01.05-E	Rev. 5 15-Nov-2007	Page 4A - 19
--------------------	-------------------------	--------------

NOTE

The pilot must ensure that a passenger sitting on a front seat is instructed in the operation of the adjustable backrest (if installed).

- 5. Adjustable backrests (if installed) adjust to the upright position described by a placard on the roll-over bar and verify proper fixation
- 6. Rudder pedals adjust, if manual pedal adjustment is installed: verify proper locking
- 7. Safety harnesses all on and fastened
- 8. POWER lever check IDLE
- 9. Parking brake set
- 10. AVIONIC MASTER check OFF
- 11. GEAR selector check DOWN
- 12. ECU SWAP check AUTOMATIC
- 13. ALTERNATORS check ON
- 14. ELECT. MASTER ON

CAUTION

When switching the ELECT. MASTER ON, the electrically driven hydraulic gear pump may activate itself for 5 to 20 seconds in order to restore the system pressure. Should the pump continue to operate continuously or periodically, terminate flight preparation. There is a malfunction in the landing gear system.

CONTINUED

Page 4A - 20	Rev. 5	15-Nov-2007	Doc. No. 7.01.05-E
--------------	--------	-------------	--------------------

- 15. G1000 wait until power-up completed.
Press ENT on MFD to acknowledge.

NOTE

The engine instruments are only available on the MFD after item 15 has been completed.

- 16. Fuel temperature check

WARNING



If Diesel Fuel or a blend of Diesel Fuel with Jet Fuel is used, (approved only if MÄM 42-037 is incorporated), or if the fuel grade is unknown, the engine must not be started if the fuel temperature indication prior to operation is below -5 °C (+23 °F).

Operation with a fuel temperature below -5 °C (+23 °F) is not permitted, as safe operation of the engine under those conditions cannot be ensured and the engine can stop.

NOTE

Make sure which fuel grade is being used (see Section 7.9.5). If it is not possible to determine the fuel grade, the Diesel Fuel temperature limitations must be observed.

END OF CHECKLIST

Doc. No. 7.01.05-E	Rev. 5 15-Nov-2007	Page 4A - 21
--------------------	-------------------------	--------------

4A.6.3 STARTING ENGINE

1. Strobe lights (ACL) ON
2. ENGINE MASTER ON (L/R)

NOTE

It is recommended to start the LH engine (pilot side) first. If required by operational reasons, the RH engine can also be started first.

3. Annunciators check „L/R ENGINE GLOW“ ON
4. Annunciators/Engine/System Page check OK/normal range

WARNING

Before starting the engine the pilot must ensure that the propeller area is free, and no persons can be endangered.

After the L/R ENGINE GLOW indication is extinguished:

5. START KEY START L/R as required / release when engine has started.

CONTINUED

Page 4A - 22	Rev. 5	15-Nov-2007	Doc. No. 7.01.05-E
--------------	--------	-------------	--------------------

CAUTION

Do not overheat the starter motor. Do not operate the starter motor for more than 10 seconds. After operating the starter motor, let it cool off for 20 seconds. After 6 attempts to start the engine, let the starter cool off for half an hour.

If the „L/R STARTER“ annunciation comes on after the engine has started and the START KEY has been released, set the ENGINE MASTER to OFF and investigate the problem.

- 6. Annunciations/Engine/System Page check OK/normal range
- 7. Annunciations/Starter check OFF
- 8. Annunciations/Oil pressure check OK

WARNING

If the oil pressure has not moved from the red range within 3 seconds after starting, set the ENGINE MASTER switch to OFF and investigate problem. When starting the cold engine, the oil pressure can be as high as 6.5 bar for a maximum of 20 seconds.

- 9. Circuit breakers check all in/as required
- 10. Idle RPM check, 900 ±20 RPM

Repeat with opposite engine.

- 11. Warm up IDLE for 2 minutes/
thereafter 1400 RPM

END OF CHECKLIST

Doc. No. 7.01.05-E	Rev. 5 15-Nov-2007	Page 4A - 23
--------------------	-------------------------	--------------

4A.6.4 BEFORE TAXIING

1. AVIONIC MASTER ON
2. Electrical equipment ON as required
3. Flight instruments and avionics set as required
4. Flood light ON, test function, as required
5. Pitot and stall warn heating ON, check annunciation

NOTE

The stall warning switch gets slightly warmer on ground only and STAL HT FAIL is indicated on the PFD.

6. Pitot and stall warn heating OFF
7. Strobe lights (ACLs) check ON
8. Position lights, landing and taxi lights as required

CAUTION

When taxiing at close range to other aircraft, or during night flight in clouds, fog or haze, the strobe lights should be switched OFF. The position lights must always be switched ON during night flight.

END OF CHECKLIST

4A.6.5 TAXIING

1. Parking brake release
2. Brakes test on moving off
3. Nose wheel steering check for proper function
4. Flight instrumentation and avionics check for correct indications
5. FUEL SELECTOR CROSSFEED (LH/RH)

CAUTION

The fuel crossfeed function can be tested simultaneously with both engines. Proper function can be tested by running the engines for approx. 30 seconds with crossfeed selected. The operation of both engines with both fuel selectors in crossfeed position, other than for this test, is prohibited.

6. FUEL SELECTOR ON (LH/RH)

CAUTION

When taxiing on a poor surface select the lowest possible RPM to avoid damage to the propeller from stones or similar items.

END OF CHECKLIST

4A.6.6 BEFORE TAKE-OFF

1. Position airplane into wind if possible.
2. Parking brake set

WARNING

For take-off the adjustable backrests (if installed) must be fixed in the upright position.

3. Adjustable backrests (if installed) verify upright position and proper fixation
4. Safety harnesses on and fastened
5. Rear door check closed and locked

CAUTION

When operating the canopy, pilots/operators must ensure that there are no obstructions between the canopy and the mating frame, for example seat belts, clothing, etc. When operating the locking handle do NOT apply undue force.

A slight downward pressure on the canopy may be required to ease the handle operation.

6. Front canopy closed and locked
7. Front baggage doors closed (visual check)
8. Door warning (DOOR) check no indication
9. Annunciators / Engine / System Page check OK / normal range (except pressure may be in the yellow range with a warm engine and power lever at IDLE)

CONTINUED

Page 4A - 26	Rev. 5	15-Nov-2007	Doc. No. 7.01.05-E
--------------	--------	-------------	--------------------

- 10. Circuit breakers check pressed in
- 11. Longitudinal Trim set T/O
- 12. FUEL SELECTOR check ON (LH/RH)
- 13. Directional Trim neutral
- 14. FLAPS check function & indicator /
set UP
- 15. Flight controls unrestricted free movement,
correct sense

NOTE

The following test sequence can be executed for both engines simultaneously, or in sequence.

FADEC test sequence:

CAUTION

If the „L/R ECU A/B FAIL“ do not illuminate and extinguish during the test sequence there is a malfunction in the engine control system. Terminate flight preparation.

The whole test procedure must be completed without any error. In case of an error terminate flight preparation, even when the engine seems to run smoothly after the test procedure.

- 1. Power lever IDLE
- 2. ECU TEST BUTTON press and hold

CONTINUED

Doc. No. 7.01.05-E	Rev. 5 15-Nov-2007	Page 4A - 27
--------------------	-------------------------	--------------

Annunciations in the following sequence:

3. ECU A/B FAIL LIGHTS ON
4. Propeller RPM increase
5. ECU A/B FAIL LIGHTS OFF
6. ECU B FAIL LIGHT ON
7. Propeller RPM decrease / increase
8. ECU B FAIL LIGHT OFF
9. ECU A FAIL LIGHT ON
10. Propeller RPM decrease / increase
11. ECU A FAIL LIGHT OFF
12. Propeller RPM decrease to idle

Test sequence completed.

CAUTION

When switching from one ECU to the other a slight shake of the engine may occur. In case of longer dropouts of the engine, or if the engine stops during the test, terminate flight preparation.

13. ECU TEST BUTTON release
14. ECU SWAP ECU B
15. Engine check running without a change
16. ECU SWAP AUTOMATIC

NOTE

When switching from one ECU to the other a slight shake of the engine may occur.

CONTINUED

Page 4A - 28	Rev. 5	15-Nov-2007	Doc. No. 7.01.05-E
--------------	--------	-------------	--------------------

CAUTION

Running the engine with the ECU SWAP on ECU B, other than for this test or in an emergency is prohibited. The engines control system redundancy is only given with the ECU SWAP set on AUTO.

- 17. Pitot heating ON, if required
- 18. Landing light ON, if required

Available power check:

- 1. POWER lever MAX for 10 seconds
- 2. Annunciations check OK/normal range
- 3. Instruments check within normal range
- 4. RPM stabilizes at 2240 to 2300 RPM
- 5. LOAD indication stabilizes at 90 to 100 %
- 6. POWER lever IDLE

CAUTION

Under high temperature and high altitude conditions, load indications below 90 % are possible. If the engine does not stabilize at the target RPM of 2240 to 2300 RPM terminate flight preparation.

- 7. Engine instruments check in green range (except oil pressure may be in yellow range with a warm engine and power lever at IDLE, and fuel temp may be in the low yellow range if the airplane is operated with Jet Fuel)

I

CONTINUED

Doc. No. 7.01.05-E	Rev. 5 15-Nov-2007	Page 4A - 29
--------------------	-------------------------	--------------

WARNING

If the airplane is operated with Diesel Fuel or a blend of Diesel Fuel with Jet Fuel (only approved if MÄM 42-037 is incorporated), or if the fuel grade is unknown, the fuel temperature must be in the green range before take-off.

END OF CHECKLIST

4A.6.7 TAKE-OFF

- 1. Transponder as required
- 2. POWER lever MAX

NOTE

The proper and symmetric performance of the engines at MAX should be checked early during the take-off run, so that the take-off can be aborted if necessary.

- 3. Elevator neutral
- 4. Rudder maintain direction

NOTE

In strong crosswinds steering can be augmented by use of the toe brakes. It should be noted, however, that this method increases the take-off roll, and should not generally be used.

- 5. Nose wheel lift-off:
 - up to 1700 kg (3748 lb) v_R minimum 70 KIAS
 - above 1700 kg (3748 lb) v_R minimum 72 KIAS
- 6. Airspeed for initial climb:
 - up to 1700 kg (3748 lb) Minimum 77 KIAS, recommended 82 KIAS (v_{YSE}) when clear of obstacles.
 - above 1700 kg (3748 lb) Minimum 79 KIAS, recommended 82 KIAS (v_{YSE}) when clear of obstacles.

CONTINUED

Doc. No. 7.01.05-E	Rev. 5 15-Nov-2007	Page 4A - 31
--------------------	-------------------------	--------------

when safe climb is established:

7. LANDING GEAR apply brakes; UP,
check unsafe light off

NOTE

To avoid damage and excessive wear of the main landing gear wheels, firmly apply brakes before selecting gear up.

END OF CHECKLIST

4A.6.8 CLIMB

Initial climb check

1. Landing light OFF / as required
2. Landing Gear check UP
3. FLAPS check UP
4. Airspeed:
 - up to 1700 kg (3748 lb) 77 KIAS (best rate-of-climb)
 85 KIAS / as required for en route
 (cruise) climb
 - above 1700 kg (3748 lb) 79 KIAS (best rate-of-climb)
 86 KIAS / as required for en-route
 (cruise) climb
5. POWER lever MAX
6. Trim as required (ball centered)
7. Annunciators/Engine/System Page monitor

CAUTION

If the oil temperature and/or coolant temperature reaches the yellow range during climb, flight should be continued with the airspeed increased by 10 kts and power reduced by 10 % (reduced climb rate) for better engine cooling.

END OF CHECKLIST

4A.6.9 CRUISE

1. POWER lever performance as required

NOTE

The engine manufacturer recommends a cruise power setting of 70 %.

2. Trim as required
3. Annunciations/Engine/System Page monitor

END OF CHECKLIST

Use of the Auxiliary fuel tanks (if installed)

The auxiliary fuel tanks are optional equipment (OÄM 42-056).

CAUTION

When operating the FUEL TRANSFER LH/RH switch, make sure not to exceed the fuel imbalance limitations given in Section 2.14.

To avoid additional imbalance in the auxiliary tanks both FUEL TRANSFER switches must be operated simultaneously.

1. Transfer the first half of the auxiliary fuel:

As soon as the fuel quantity in each main fuel tank is 17 US gal or less, set both FUEL TRANSFER switches to ON until the main tanks are full again.

CONTINUED

Page 4A - 34	Rev. 5	15-Nov-2007	Doc. No. 7.01.05-E
--------------	--------	-------------	--------------------

- █ Monitor the fuel quantity indicator to verify that fuel is properly transferred to both main fuel tanks (approx. 1 US gal per minute). If the fuel quantity in a main tank does not increase during fuel transfer, proceed according to Section 4B.10 - L/R FUEL TRANSFER FAIL.

2. *Transfer the second half of the auxiliary fuel:*

Repeat the procedure described above.

NOTE

Transfer the fuel from the auxiliary tanks to the main tanks as soon as possible. The fuel in the auxiliary tanks must be transferred to the main tanks to become available for the current flight mission.

END OF CHECKLIST

4A.6.10 DESCENT

1. POWER lever as required
2. Airspeed as required
3. Trim as required
4. Annunciations/Engine/System Page monitor

END OF CHECKLIST

Doc. No. 7.01.05-E	Rev. 5 15-Nov-2007	Page 4A - 35
--------------------	-------------------------	--------------

4A.6.11 APPROACH & LANDING

Approach:

WARNING

For landing the adjustable backrests (if installed) must be fixed in the upright position.

1. Adjustable backrests (if installed) adjust to the upright position described by a placard on the roll-over bar and verify proper fixation

NOTE

If the landing mass exceeds 1700 kg (3748 lb), the landing constitutes an abnormal operating procedure. Refer to Section 4B.8.

2. Safety harnesses check fastened and tightened
3. Controls no interference by foreign objects
4. Landing light as required
5. Gear warning horn check function
6. Fuel Selector check ON
7. LANDING GEAR DOWN, check 3 green
8. Parking brake check released
9. Trim as required, directional trim neutral

CONTINUED

Page 4A - 36	Rev. 5	15-Nov-2007	Doc. No. 7.01.05-E
--------------	--------	-------------	--------------------

Before landing:

- 10. Airspeed min. 82 KIAS with FLAPS APP
min. 85 KIAS with FLAPS UP
- 11. FLAPS as required
- 12. POWER lever as required
- 13. Trim as required, directional trim
neutral
- 14. Final Approach speed min. 76 KIAS with FLAPS LDG

NOTE

Higher approach speeds result in a significantly longer landing distance during flare.

CAUTION

In conditions such as (e.g.) strong wind, danger of wind shear or turbulence a higher approach speed should be selected.

END OF CHECKLIST

4A.6.12 GO AROUND

1. POWER lever MAX
2. Airspeed min. 82 KIAS
3. FLAPS position APP

when a positive rate of climb is established:

4. Landing Gear UP, check unsafe light off
5. FLAPS retract, position UP

END OF CHECKLIST

4A.6.13 AFTER LANDING

1. POWER lever IDLE
2. Brakes as required
3. Transponder OFF / STBY
4. Pitot heating OFF
5. Avionics as required
6. Lights as required
7. FLAPS UP

END OF CHECKLIST

4A.6.14 SHUT-DOWN

1. Parking brake set
2. POWER lever IDLE for 2 minutes
3. Engine/System Page check
4. ELT check not transmitting on
121.5 MHz
5. AVIONIC MASTER OFF
6. Electrical consumers OFF
7. ENGINE MASTER OFF
8. Anti collision lights (ACL) OFF
9. ELECT. MASTER OFF

CAUTION

Before shut-down the engine must run for at least 2 minutes with the power lever at IDLE to avoid heat damage of the turbo charger.

CAUTION

Do not shut down an engine with the fuel selector valve. The high pressure fuel pump can otherwise be damaged.

END OF CHECKLIST

4A.6.15 EXIT AIRPLANE

Exit the airplane to the aft on designated areas on the inner wing section LH or RH.

4A.6.16 POST FLIGHT INSPECTION

1. Record any problem found in flight and during the post-flight check in the log book.
2. Park the airplane.
3. If necessary, moor the airplane.

END OF CHECKLIST

4A.6.17 PARKING

1. Parking brake release, use chocks
2. Airplane moor, if unsupervised for
extended period
3. PITOT probe cover

END OF CHECKLIST

4A.6.18 FLIGHT IN RAIN**NOTE**

Performance deteriorates in rain; this applies particularly to the take-off distance and to the maximum horizontal speed. The effect on the flight characteristics is minimal. Flight through very heavy rain should be avoided because of the associated visibility problems.

4A.6.19 REFUELING**CAUTION**

Before refueling, the airplane must be connected to electrical ground. Grounding points: unpainted areas on steps, left and right. Refer to Section 2.14 for approved fuel grades.

NOTE

If the airplane is operated with Diesel Fuel (only approved if MÄM 42-037 is incorporated), additional temperature limitations (refer to Section 2.16.1) must be observed.

- | If Jet Fuel is used, make sure that no Diesel Fuel is remaining in the tanks, neither in the left nor in the right tank (see fuel grade, Section 7.9.5). Otherwise the temperature limitations
- | for Diesel Fuel operation must be observed.

Refueling of the Auxiliary Tanks (if installed)

CAUTION

If the auxiliary tanks are used, then both tanks must be refueled to the maximum level. Only then the pilot has proper information concerning the fuel quantity in the auxiliary tanks.

If the auxiliary tanks are not in use, make sure that they are empty (refer to Section 6.4).

CAUTION

If the airplane is operated with Diesel Fuel or a blend of Diesel Fuel with Jet Fuel (only approved if MÄM 42-037 is incorporated), the use of the auxiliary tanks is not permitted.

4A.6.20 FLIGHT AT HIGH ALTITUDE

At high altitudes the provision of oxygen for the occupants is necessary. Legal requirements for the provision of oxygen should be adhered to.

Also see Section 2.11 - OPERATING ALTITUDE.

CHAPTER 4B

ABNORMAL OPERATING PROCEDURES

	Page
4B.1 PRECAUTIONARY LANDING	3
4B.2 CANOPY IN COOLING GAP POSITION	5
4B.3 ENGINE INSTRUMENT INDICATIONS OUTSIDE OF GREEN RANGE ON THE G1000	5
4B.3.1 RPM	5
4B.3.2 COOLANT TEMPERATURE	6
4B.3.3 OIL TEMPERATURE	7
4B.3.4 OIL PRESSURE	8
4B.3.5 GEARBOX TEMPERATURE	9
4B.3.6 FUEL TEMPERATURE	9
4B.3.7 VOLTAGE	10
4B.4 CAUTION-ALERTS ON THE G1000	11
4B.4.1 CAUTIONS / GENERAL	11
4B.4.2 L/R ECU A FAIL	12
4B.4.3 L/R ECU B FAIL	13
4B.4.4 L/R FUEL LOW	14
4B.4.5 LOW VOLTAGE CAUTION (LOW VOLTS)	15
4B.4.6 L/R ALTN FAIL	16
4B.4.7 L/R COOL LVL	17
4B.4.8 PITOT FAIL / HT OFF	18
4B.4.9 STALL HT FAIL/OFF	19
4B.4.10 L/R AUXILIARY FUEL TANK EMPTY (IF AUX. TANKS INSTALLED)	20
4B.4.11 STICK LIMIT	21
4B.4.12 CHECK GEAR (IF INSTALLED)	22

	4B.4.13 RAIM UNAVAIL	22
	4B.4.14 AHRS ALIGNING - KEEP WINGS LEVEL	23
	4B.5 FAILURES IN FLAP OPERATING SYSTEM	24
I	4B.6 FAILURES IN ELECTRICAL RUDDER PEDAL ADJUSTMENT	25
	4B.7 FAILURES IN HYDRAULIC SYSTEM	26
	4B.7.1 CONTINUOUS HYDRAULIC PUMP OPERATION	26
	4B.7.2 HYDRAULIC PUMP FAILURE	26
	4B.8 STARTING ENGINE WITH EXTERNAL POWER	27
	4B.8.1 BEFORE STARTING ENGINE	27
	4B.8.2 STARTING ENGINE	29
	4B.9 LANDING WITH HIGH LANDING MASS	31
I	4B.10 L/R FUEL TRANSFER FAIL (IF AUX. TANKS ARE INSTALLED)	32

4B.1 PRECAUTIONARY LANDING

NOTE

A landing of this type is only necessary when there is a reasonable suspicion that due to operational factors such as fuel shortage, weather conditions, etc. the possibility of endangering the airplane and its occupants by continuing the flight cannot be excluded. The pilot is required to decide whether or not a controlled landing in a field represents a lower risk than the attempt to reach the nearest airfield under all circumstances.

NOTE

If no level landing area is available, a landing on an upward slope should be sought.

1. Select appropriate landing area.
2. Consider wind.
3. Approach:

If possible, the landing area should be overflown at a suitable height in order to recognize obstacles. The degree of offset at each part of the circuit will allow the wind speed and direction to be assessed.

4. ATC advise

Perform procedures according to Normal Procedures 4A.6.11
- APPROACH & LANDING.

5. Touchdown with the lowest possible airspeed

CONTINUED

Doc. No. 7.01.05-E	Rev. 5 15-Nov-2007	Page 4B - 3
--------------------	-------------------------	-------------

CAUTION

If sufficient time is remaining, the risk of fire in the event of a collision with obstacles can be reduced as follows after a safe touch-down:

- ENGINE MASTER both OFF
- FUEL SELECTOR both OFF
- ELECT. MASTER OFF

END OF CHECKLIST

4B.2 CANOPY IN COOLING GAP POSITION**CAUTION**

If take-off was inadvertently done with the canopy in the Cooling Gap position, do not attempt to close the canopy in flight. Land the airplane and close the canopy on ground.

4B.3 ENGINE INSTRUMENT INDICATIONS OUTSIDE OF GREEN RANGE ON THE G1000**4B.3.1 RPM**High RPM

1. Reduce power of affected engine.
2. Keep RPM within the green range using the power lever.

If the above mentioned measures do not solve the problem, refer to 3.9.3 - DEFECTIVE PROPELLER RPM REGULATING SYSTEM.

3. Land at the nearest suitable airfield.

END OF CHECKLIST

4B.3.2 COOLANT TEMPERATURE

(a) High coolant temperature

Proceed according to:

3.2.2 - L/R ENG TEMP

(b) Low coolant temperature

- Check G1000 for L/R COOL LVL caution message (low coolant level).

NOTE

During an extended descent from high altitudes with a low power setting coolant temperature may decrease. In this case an increase in power and a decrease in airspeed can help.

L/R COOL LVL caution message displayed:

- Reduce power on affected engine.
- Expect loss of coolant.

WARNING

A further decrease in coolant temperature must be expected. Prepare for an engine failure in accordance with 3.5.6 - ENGINE FAILURES IN FLIGHT.

END OF CHECKLIST

4B.3.3 OIL TEMPERATURE**(a) High oil temperature**

Proceed according to:

3.2.3 - L/R OIL TEMP**(b) Low oil temperature****NOTE**

During an extended descent from high altitudes with a low power setting oil temperature may decrease. In this case an increase in power can help.

- Increase power.
- Reduce airspeed.

END OF CHECKLIST

4B.3.4 OIL PRESSURE

(a) High oil pressure

- Check oil temperature.
- Check coolant temperature.

if the temperatures are within the green range:

- Expect false oil pressure indication. Keep monitoring temperatures.

if the temperatures are outside of the green range:

- Reduce power on affected engine.

WARNING

Land at the nearest suitable airfield. Prepare for an engine failure in accordance with 3.5.6 - ENGINE FAILURES IN FLIGHT.

CAUTION

When starting a cold engine, the oil pressure can be as high as 6.5 bar for a maximum of 20 seconds.

END OF CHECKLIST

(b) Low oil pressure

Proceed according to:

3.2.4 - L/R OIL PRES

4B.3.5 GEARBOX TEMPERATURE

High gearbox temperature

Proceed according to:

3.2.5 - L/R GBOX TEMP

4B.3.6 FUEL TEMPERATURE

(a) High fuel temperature

Proceed according to:

3.2.6 - L/R FUEL TEMP

(b) Low fuel temperature

- Increase power on affected engine.
- Reduce airspeed.

CAUTION

At low ambient temperature conditions and/or at high airspeeds with low power settings, it can be assumed that the above mentioned procedure will increase the temperature(s). If the fuel temperature does not return to the green range perform a precautionary landing on the nearest suitable airfield. Prepare for an engine failure in accordance with 3.5.6 - ENGINE FAILURES IN FLIGHT.

END OF CHECKLIST

4B.3.7 VOLTAGE

(a) Low voltage indication on the ground

1. Circuit breakers check
2. POWER lever increase RPM

if LOW VOLTAGE CAUTION (4B.4.5 - LOW VOLTS) is still indicated on the G1000:

- Terminate flight preparation.

END OF CHECKLIST

(b) Low voltage during flight

1. Circuit breakers check
2. Electrical equipment OFF if not needed

if LOW VOLTAGE CAUTION (4B.4.5 - LOW VOLTS) is still indicated on the G1000:

- Follow procedure in 4B.4.6 - L/R ALTN FAIL.

END OF CHECKLIST

4B.4 CAUTION-ALERTS ON THE G1000

The G1000 provides the following CAUTION-alerts on the PFD in the ALERT area.

4B.4.1 CAUTIONS / GENERAL

CHARACTERISTICS	* Amber color coded text * Single warning chime tone of 1.5 seconds duration
------------------------	---

4B.4.2 L/R ECU A FAIL

L/R ECU A FAIL	* Left/Right engine ECU A has failed or * is being tested during FADEC test procedure before take-off check.
-----------------------	--

(a) 'ECU A' caution on the ground

- Terminate flight preparation.

(b) 'ECU A' caution during flight

NOTE

In case of a failure in the electronic ECU (Engine Control Unit) 'A' the system automatically switches to ECU 'B'.

1. Press the ECU TEST button for more than 2 seconds to reset the caution message.

If the ECU A caution message reappears, or cannot be reset:

2. Land on the nearest suitable airfield.
3. The engine must be serviced after landing.

If the ECU A caution message can be reset:

2. Continue flight.
3. The engine must be serviced after landing.

END OF CHECKLIST

Page 4B - 12	Rev. 5	15-Nov-2007	Doc. No. 7.01.05-E
--------------	--------	-------------	--------------------

4B.4.3 L/R ECU B FAIL

L/R ECU B FAIL	<ul style="list-style-type: none"> * Left/Right engine ECU B has failed or * is being tested during FADEC test procedure before take-off check.
-----------------------	--

(a) 'ECU B' caution on the ground

- Terminate flight preparation.

(b) 'ECU B' caution during flight

1. Press the ECU TEST button for more than 2 seconds to reset the caution message.

If the ECU B caution message reappears, or cannot be reset:

2. Land on the nearest suitable airfield.
3. The engine must be serviced after landing.

If the ECU B caution message can be reset:

2. Continue flight.
3. The engine must be serviced after landing.

END OF CHECKLIST

4B.4.4 L/R FUEL LOW

L/R FUEL LOW	Left / Right engine main tank fuel quantity is low.
---------------------	---

1. Fuel quantity check

CAUTION

As soon as the amount of usable fuel in the main tank is low, a caution message is displayed. The indication is calibrated for straight and level flight. The caution message may be triggered during turns which are flown with slip, or while taxiing in curves.

if fuel quantities of LH & RH engines show remarkable different fuel quantities in flight:

- Expect loss of fuel on side with lower indication.
- Use crossfeed function to ensure fuel supply.

2. FUEL SELECTOR crossfeed (engine with LOW FUEL indication)

END OF CHECKLIST

4B.4.5 LOW VOLTAGE CAUTION (LOW VOLTS)**L/R VOLTS LOW**

Left/Right engine bus voltage is too low (less than 25 volts)

Possible reasons are:

- A fault in the power supply.
- RPM too low.

Continue with 4B.3.7 - VOLTAGE.

CAUTION

If both Low Voltage indications are ON, expect failure of both
Alternators and follow 4B.4.6 - L/R ALTN FAIL.

END OF CHECKLIST

4B.4.6 L/R ALTN FAIL

L/R ALTN FAIL	Left/Right engine alternator has failed.
----------------------	--

(a) One alternator failed

1. ALTERNATOR OFF/affected side
2. Bus voltage monitor
3. Electrical consumers reduce as practicable

END OF CHECKLIST

(b) Both alternators failed

WARNING

If both alternators fail at the same time, reduce all electrical equipment to a minimum. Expect battery power to last 30 minutes and land the airplane as soon as possible. Expect engine stoppage after this period of time.

1. Avionics Master OFF
2. LH/RH Alternator OFF
3. XPDR STBY
4. LANDING GEAR down, when down and locked pull
Emergency Release
5. Stall/Pitot heat OFF
6. All lights OFF

END OF CHECKLIST

Page 4B - 16	Rev. 5	15-Nov-2007	Doc. No. 7.01.05-E
--------------	--------	-------------	--------------------

4B.4.7 L/R COOL LVL

L/R COOL LVL	Left/Right engine coolant level is low.
---------------------	---

A low coolant caution alert may indicate a loss of coolant. This will subsequently lead to decreased engine cooling capability/loss of engine power due to engine failure.

1. Annunciations/Engine instruments monitor

See 4B.3.2 COOLANT TEMPERATURE.

NOTE

The indication is calibrated for straight and level flight. The caution message may be triggered during turns which are flown with slip, or while taxiing in curves.

END OF CHECKLIST

Doc. No. 7.01.05-E	Rev. 5 15-Nov-2007	Page 4B - 17
--------------------	-------------------------	--------------

4B.4.8 PITOT FAIL / HT OFF

PITOT FAIL	Pitot heating system has failed.
PITOT HT OFF	Pitot heating system is OFF.

1. PITOT HEAT check ON/as required

NOTE

The Pitot heating caution message is displayed when the Pitot heating is switched OFF, or when there is a failure of the Pitot heating system. Prolonged operation of the Pitot heating on the ground can also cause the Pitot heating caution message to be displayed. In this case it indicates the activation of the thermal switch, which prevents overheating of the Pitot heating system on the ground. This is a normal function of the system. After a cooling period, the heating system will be switched on again automatically.

if in icing conditions:

2. Expect loss of static instruments.
3. Open Alternate Static.
4. Leave icing zone / refer to 3.9.4 - UNINTENTIONAL FLIGHT INTO ICING.

END OF CHECKLIST

4B.4.9 STALL HT FAIL/OFF

STAL HT FAIL	Stall warning heat has failed.
STAL HT OFF	Stall warning heat is OFF.

1. PITOT HEAT check ON/as required

NOTE

The STAL HT OFF caution message is displayed when the Pitot heating is switched OFF, or STAL HT FAIL when there is a failure of the stall warning heating system. Operation of the stall warning heating on the ground also causes the stall warning heating failed caution message to be displayed. In this case it indicates the activation of the thermal protection relay, which prevents overheating of the stall warning heating system on the ground. This is a normal function of the system.

if in icing conditions:

2. Expect loss of acoustic stall warning.
3. Leave icing zone / refer to 3.9.4 UNINTENTIONAL FLIGHT INTO ICING.

END OF CHECKLIST

4B.4.10 L/R AUXILIARY FUEL TANK EMPTY (IF AUX. TANKS INSTALLED)

L/R AUX FUEL E	Left / Right auxiliary fuel tank empty (displayed only when FUEL TRANSFER pump is ON)
-----------------------	---

The auxiliary tank empty caution message indicates an empty auxiliary fuel tank while the fuel pump is switched ON.

1. L/R auxiliary fuel pump OFF

END OF CHECKLIST

4B.4.11 STICK LIMIT

STICK LIMIT	Control stick limiting system (variable elevator stop) has failed.
--------------------	--

The variable elevator backstop is activated depending on the position of the power levers and the position of the flap selector switch. The system has two failure modes which can be identified as follows:

- (a) Both power levers are in a position for a power setting of more than approximately 20 % LOAD, and the FLAP selector switch is in LDG position:

CAUTION

The variable elevator backstop is inoperative. In case of stalling with "power-on" the handling qualities and stall-characteristics are degraded significantly.

Do not stall the airplane in any configuration.

- (b) At least one power lever is in a position for a power setting of less than approximately 20 % LOAD, or the FLAP selector switch is not in LDG position:

CAUTION

The variable elevator backstop is active all the time, reducing the maximum elevator "pull"-deflection. This results in reduced elevator capacity. In this case it is important not to reduce airspeed below required minimum v_{REF} during the approach for landing, especially at loading conditions with forward locations of the center of gravity.

up to 1700 kg (3748 lb) $v_{REF} = 76$ KIAS

above 1700 kg (3748 lb) $v_{REF} = 78$ KIAS

(see Section 4B.8)

END OF CHECKLIST

Doc. No. 7.01.05-E	Rev. 5 15-Nov-2007	Page 4B - 21
--------------------	-------------------------	--------------

4B.4.12 CHECK GEAR (IF INSTALLED)

CHECK GEAR	Landing gear is not down and locked.
-------------------	--------------------------------------

1. Landing gear Down/as required

NOTE

If installed the Check Gear caution message is displayed when either the flaps are in LDG position or one power lever is less than approx. 20% and the landing gear is not down and locked.

END OF CHECKLIST

4B.4.13 RAIM UNAVAIL

INTEG	RAIM (Receiver Autonomous Integrity Monitor) is not available.
RAIM not available	

- (a) Enroute, oceanic, terminal, or initial approach phase of flight

If the "RAIM UNAVAIL" annunciation is displayed in the enroute, oceanic, terminal, or initial approach phase of flight, continue to navigate using the GPS equipment or revert to an alternate means of navigation other than the G1000 GPS receiver appropriate to the route and phase of flight. When continuing to use GPS navigation, position must be verified every 15 minutes using the G1000 VOR/ILS receiver or another IFR-approved navigation system.

END OF CHECKLIST

(b) Final approach

If the "RAIM UNAVAIL" annunciation is displayed while on the final approach segment, GPS based navigation will continue for up to 5 minutes with approach CDI sensitivity (0.3 nautical miles). After 5 minutes the system will flag and no longer provide course guidance with approach sensitivity. Missed approach course guidance may still be available with 1 nautical mile CDI sensitivity and integrity by executing the missed approach.

END OF CHECKLIST

4B.4.14 AHRS ALIGNING - KEEP WINGS LEVEL

AHRS ALIGN: Keep Wings Level	The AHRS (Attitude and Heading Reference System) is aligning.
------------------------------------	---

Keep wings level using standby attitude indicator.

END OF CHECKLIST

4B.5 FAILURES IN FLAP OPERATING SYSTEM

Failure in position indication or function

1. FLAPS position check visually
2. Airspeed keep in white sector
(max. 111 KIAS)
3. FLAPS switch re-check all positions

Modified approach procedure depending on the available flap setting

(a) Only UP available:

Airspeed

up to 1700 kg (3748 lb) min. 85 KIAS

above 1700 kg (3748 lb) min. 86 KIAS (see Section 4B.8)

Land at a flat approach angle, use power lever to control airplane speed and rate of descent.

(b) Only APP available:

Airspeed min. 82 KIAS

Land at a flat approach angle, use power lever to control airplane speed and rate of descent.

(c) Only LDG available:

Perform normal landing.

END OF CHECKLIST

Page 4B - 24	Rev. 5	15-Nov-2007	Doc. No. 7.01.05-E
--------------	--------	-------------	--------------------

4B.6 FAILURES IN ELECTRICAL RUDDER PEDAL ADJUSTMENT

Runaway of electrical rudder pedal adjustment (optional equipment, OÄM 42-070)

NOTE

The circuit breaker for the rudder pedal adjustment is located below the related switch, on the rear wall of the leg room.

1. Circuit breaker pull

END OF CHECKLIST

4B.7 FAILURES IN HYDRAULIC SYSTEM

4B.7.1 CONTINUOUS HYDRAULIC PUMP OPERATION

1. Landing gear indication lights check
2. Prepare for manual landing gear extension. Refer to Section 3.6.2 - MANUAL EXTENSION OF THE LANDING GEAR.

NOTE

The landing gear might extend as the hydraulic system pressure decreases. Consider for higher aerodynamic drag, resulting in degraded flight performance, increased fuel consumption and decreased range.

Unscheduled maintenance action is required after landing.

END OF CHECKLIST

4B.7.2 HYDRAULIC PUMP FAILURE

1. Landing gear indication lights check
2. Prepare for manual landing gear extension. Refer to Section 3.6.2 - MANUAL EXTENSION OF THE LANDING GEAR.

NOTE

The landing gear might extend as the hydraulic system pressure decreases. Consider for higher aerodynamic drag, resulting in degraded flight performance, increased fuel consumption and decreased range.

Unscheduled maintenance action is required after landing.

END OF CHECKLIST

Page 4B - 26	Rev. 5	15-Nov-2007	Doc. No. 7.01.05-E
--------------	--------	-------------	--------------------

4B.8 STARTING ENGINE WITH EXTERNAL POWER

4B.8.1 BEFORE STARTING ENGINE

1. Pre-flight inspection complete
2. Passengers instructed

NOTE

Ensure all the passengers have been fully briefed on the use of the seat belts, adjustable backrests (if installed), doors and emergency exits and the ban on smoking.

3. Rear door closed and locked
4. Front canopy Position 1 or 2 (“cooling gap”)
5. Rudder pedals adjusted and locked
6. Safety harnesses all on and fastened
7. POWER lever check IDLE
8. Parking brake set
9. AVIONIC MASTER check OFF
10. GEAR selector check DOWN
11. ECU SWAP check AUTOMATIC
12. ALTERNATORS check ON
13. ELECT. MASTER check OFF
14. ENGINE MASTER check OFF
15. PROPELLER check clear
16. External power connect

CONTINUED

Doc. No. 7.01.05-E	Rev. 5	15-Nov-2007	Page 4B - 27
--------------------	--------	-------------	--------------

CAUTION

When switching the External Power Unit ON, the electrically driven hydraulic gear pump may activate itself for 5 to 20 seconds in order to restore the system pressure. Should the pump continue to operate continuously or periodically, terminate flight. There is a malfunction in the landing gear system.

NOTE

When switching the External Power Unit ON, all electrical equipment, connected to the LH and RH main busses is powered.

17. G1000 wait until power-up completed.
Press ENT on MFD to
acknowledge.

NOTE

The engine instruments are only available on the MFD after item 17 has been completed.

END OF CHECKLIST

4B.8.2 STARTING ENGINE

- 1. Strobe lights (ACL) ON
- 2. ELECT. MASTER ON
- 3. ENGINE MASTER ON (LH side)
- 4. Annunciations check „L ENGINE GLOW" ON
- 5. Annunciations/Engine/System Page check OK/normal range

WARNING

Before starting the engine the pilot must ensure that the propeller area is free, and no persons can be endangered.

After the L ENGINE GLOW indication is extinguished:

- 6. START KEY START L as required/release when engine has started

CAUTION

Do not overheat the starter motor. Do not operate the starter motor for more than 10 seconds. After operating the starter motor, let it cool off for 20 seconds. After 6 attempts to start the engine, let the starter cool off for half an hour.

If the „L/R STARTER" annunciation does not extinguish after the engine has started and the START KEY has been released, set the ENGINE MASTER to OFF and investigate the problem.

CONTINUED

Doc. No. 7.01.05-E	Rev. 5 15-Nov-2007	Page 4B - 29
--------------------	-------------------------	--------------

- 7. Annunciations / Engine / System Page check OK / normal range
- 8. Annunciations / Starter check OFF
- 9. Annunciations / Oil pressure check OK

WARNING

If the oil pressure has not moved from the red range within 3 seconds after starting, set the ENGINE MASTER switch to OFF and investigate problem. When starting the cold engine, the oil pressure can be as high as 6.5 bar for a maximum of 20 seconds.

- 10. Circuit breakers check all in / as required
- 11. Idle RPM check, 900 ±20 RPM
- 12. External Power disconnect
- 13. Opposite engine Start with normal procedure
- 14. Warm up IDLE for 2 minutes /
thereafter 1400 RPM

END OF CHECKLIST

4B.9 LANDING WITH HIGH LANDING MASS

CAUTION

Damage of the landing gear can result from a hard landing with a flight mass above the maximum landing mass.

NOTE

If MÄM 42-088 is carried out, a landing with a mass between 1700 kg (3748 lb) and 1785 kg (3935 lb) is admissible. It constitutes an abnormal operating procedure. A "Hard Landing Check" is only required after a hard landing, regardless of the actual landing mass. Refer to Section 4A.6.11 - APPROACH & LANDING for landings with a mass up to 1700 kg (3748 lb).

Perform landing approach according to Section 4A.6.11 - APPROACH & LANDING, but maintain an increased airspeed during final landing approach.

- Approach speed min. 82 KIAS with FLAPS APP
min. 86 KIAS with FLAPS UP
- Final approach speed min. 78 KIAS with FLAPS LDG
- Minimum speed on go-around 82 KIAS

END OF CHECKLIST

4B.10 L/R FUEL TRANSFER FAIL (IF AUX. TANKS ARE INSTALLED)

If the fuel quantity in a main tank does not increase during fuel transfer:

1. Switch OFF both fuel transfer pumps.

CAUTION

An imbalance in the auxiliary tanks is approved when the imbalance in the main tanks is less than 1 US gal (3.8 liters).

2. Check fuel imbalance in the main tanks; use crossfeed function to keep the LH and RH main tank imbalance within the permissible limit of 1 US gal (3.8 liters).
3. Switch the remaining fuel pump ON.
4. Use crossfeed function to keep the LH and RH main tank imbalance within the permissible limit of 1 US gal (3.8 liters).

END OF CHECKLIST

CHAPTER 5

PERFORMANCE

	Page
5.1 INTRODUCTION	5-2
5.2 USE OF THE PERFORMANCE TABLES AND DIAGRAMS	5-2
5.3 PERFORMANCE TABLES AND DIAGRAMS	5-3
5.3.1 AIRSPEED CALIBRATION	5-3
5.3.2 FUEL FLOW DIAGRAM	5-6
5.3.3 INTERNATIONAL STANDARD ATMOSPHERE	5-7
5.3.4 STALLING SPEEDS	5-8
5.3.5 WIND COMPONENTS	5-9
5.3.6 TAKE-OFF DISTANCE	5-10
5.3.7 CLIMB PERFORMANCE - TAKE-OFF CLIMB	5-17
5.3.8 CLIMB PERFORMANCE - CRUISE CLIMB	5-20
5.3.9 ONE ENGINE INOPERATIVE CLIMB PERFORMANCE ...	5-23
5.3.10 CRUISING (TRUE AIRSPEED TAS)	5-26
5.3.11 LANDING DISTANCE	5-28
5.3.12 GRADIENT OF CLIMB ON GO-AROUND	5-34
5.3.13 APPROVED NOISE DATA	5-35

5.1 INTRODUCTION

The performance tables and diagrams on the following pages are presented so that, on the one hand, you can see what performance you can expect from your airplane, while on the other they allow comprehensive and sufficiently accurate flight planning. The values in the tables and the diagrams were obtained in the framework of the flight trials using an airplane and power-plant in good condition, and corrected to the conditions of the International Standard Atmosphere (ISA = 15 °C / 59 °F and 1,013.25 hPa / 29.92 inHg at sea level).

The performance diagrams do not take into account variations in pilot experience or a poorly maintained airplane. The performances given can be attained if the procedures quoted in this manual are applied, and the airplane has been well maintained.

5.2 USE OF THE PERFORMANCE TABLES AND DIAGRAMS

In order to illustrate the influence of a number of different variables, the performance data is reproduced in the form of tables or diagrams. These contain sufficiently detailed information so that conservative values can be selected and used for the determination of adequate performance data for the planned flight.

5.3 PERFORMANCE TABLES AND DIAGRAMS

5.3.1 AIRSPEED CALIBRATION

NOTE

The position of the landing gear (extended/retracted) has no influence on the airspeed indicator system.

**AIRSPEED INDICATOR SYSTEM
FLAPS UP**

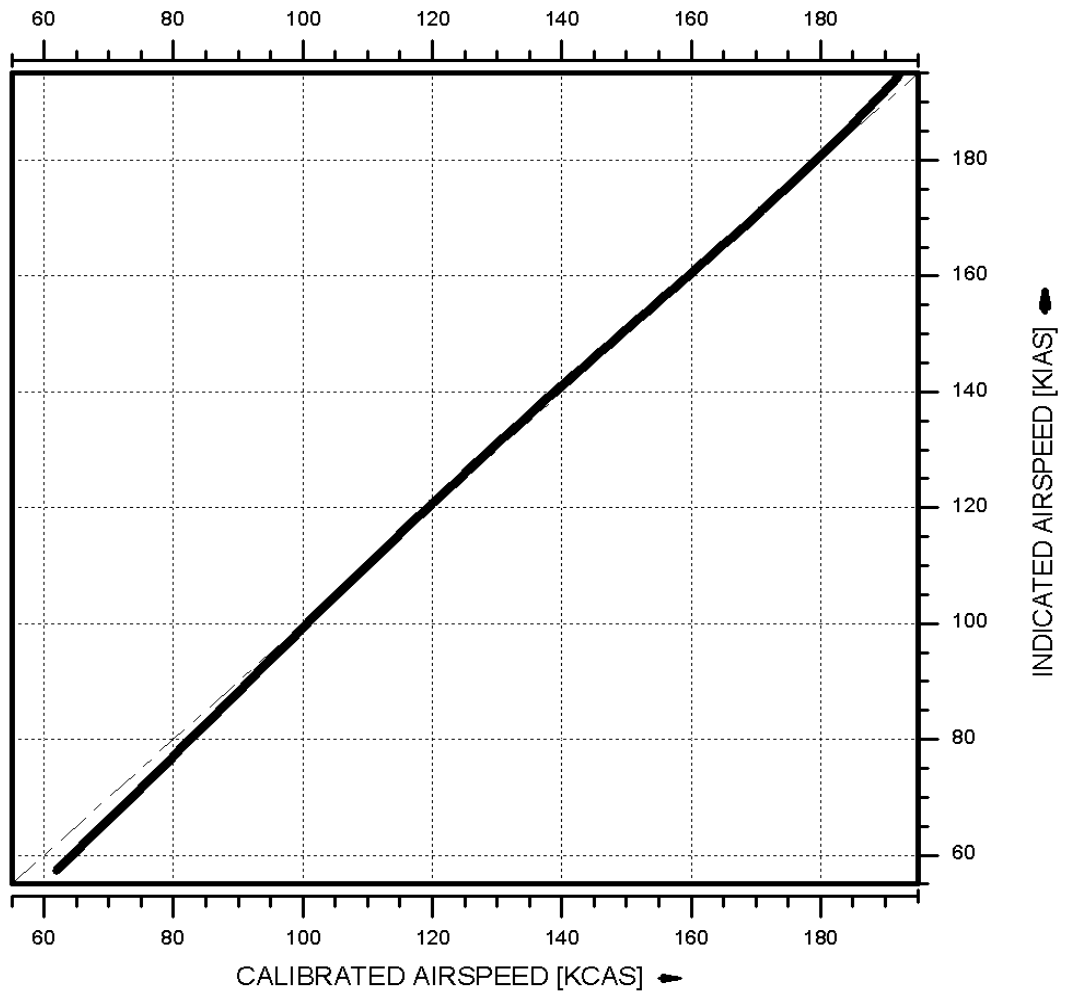

AIRSPEED INDICATOR SYSTEM

FLAPS APP

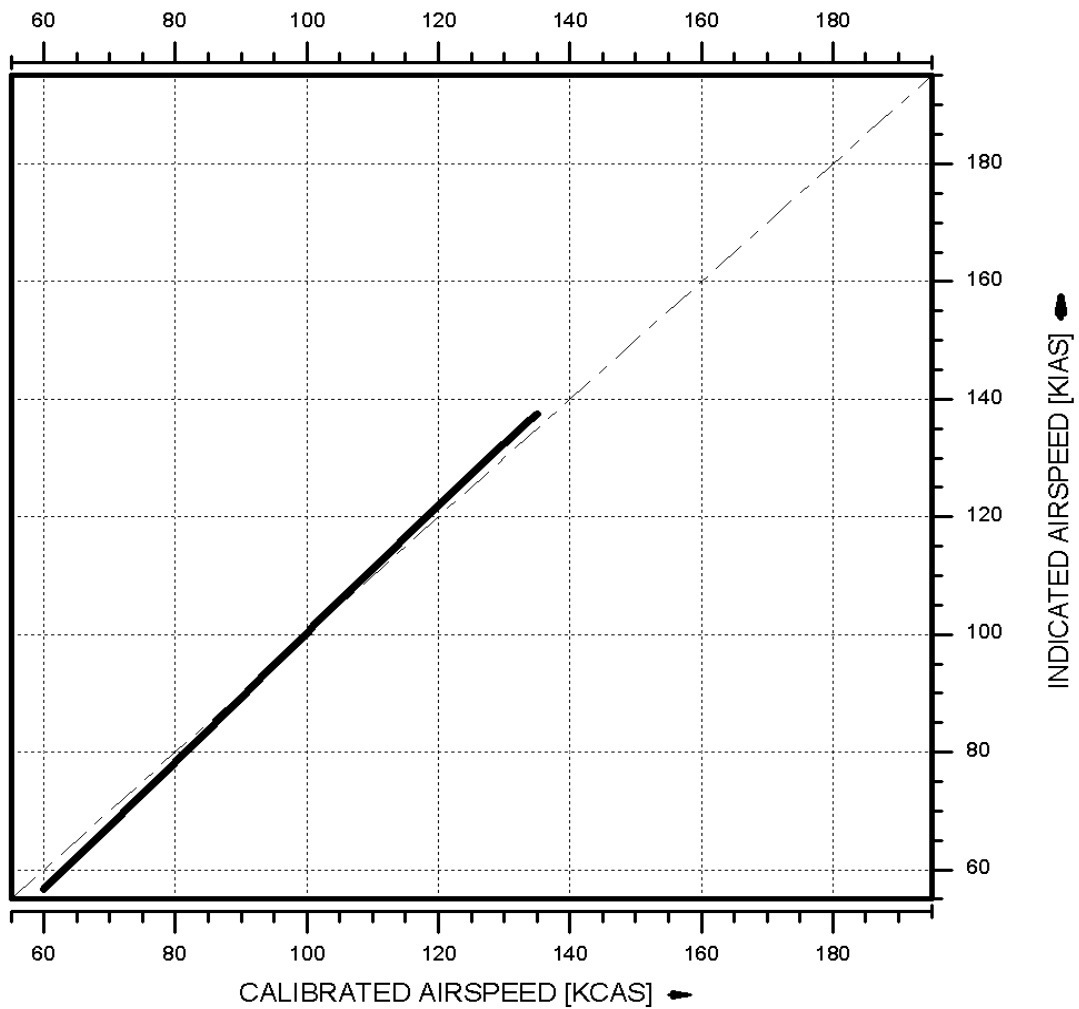

AIRSPEED INDICATOR SYSTEM

FLAPS LDG

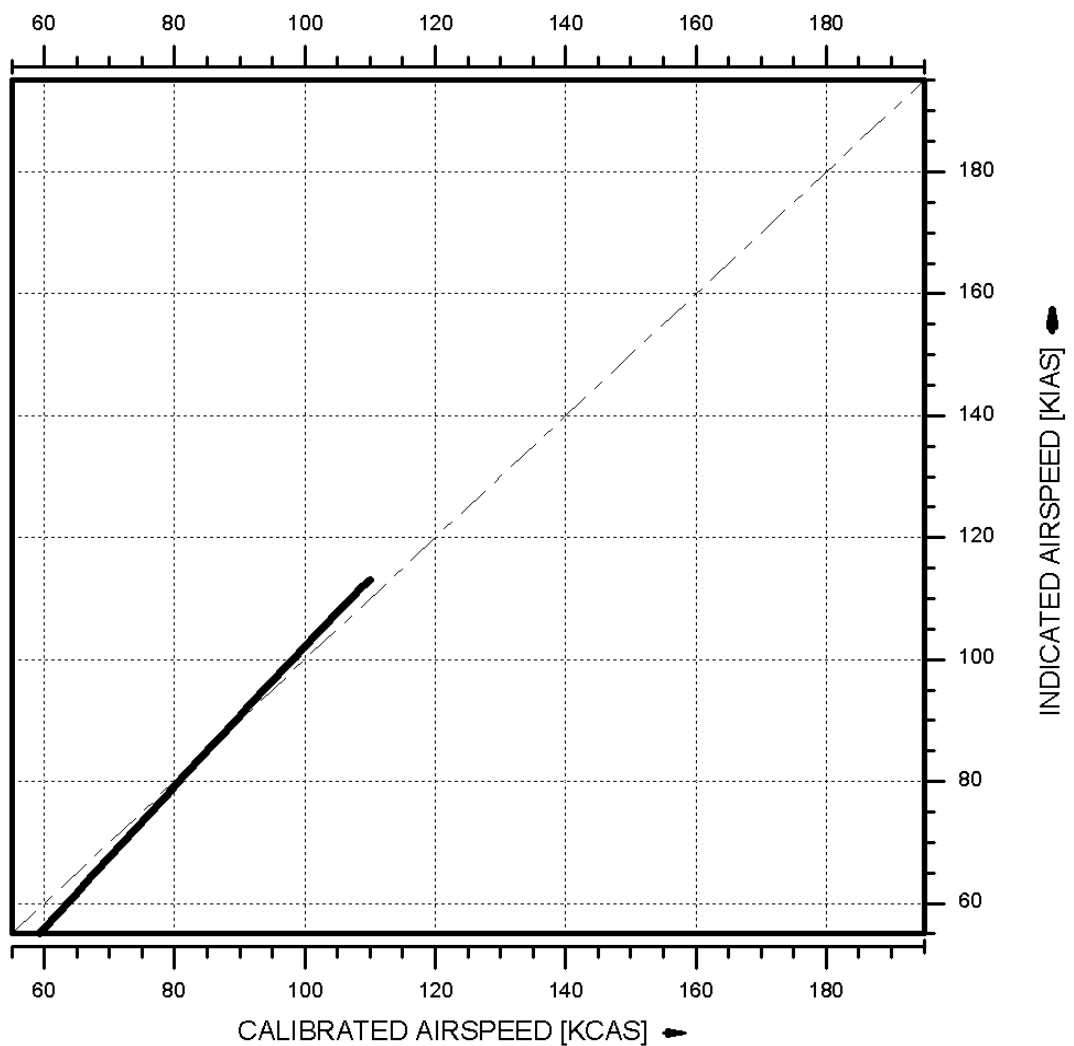

5.3.2 FUEL FLOW DIAGRAM

CAUTION

The diagram shows the fuel flow per hour for one engine.

NOTE

The fuel calculations on the FUEL CALC portion of the G1000 MFD do not use the airplane's fuel quantity indicators. The values shown are numbers which are calculated from the last fuel quantity update done by the pilot and actual fuel flow data. Therefore, the endurance and range data is for information only, and must not be used for flight planning.

FUEL FLOW

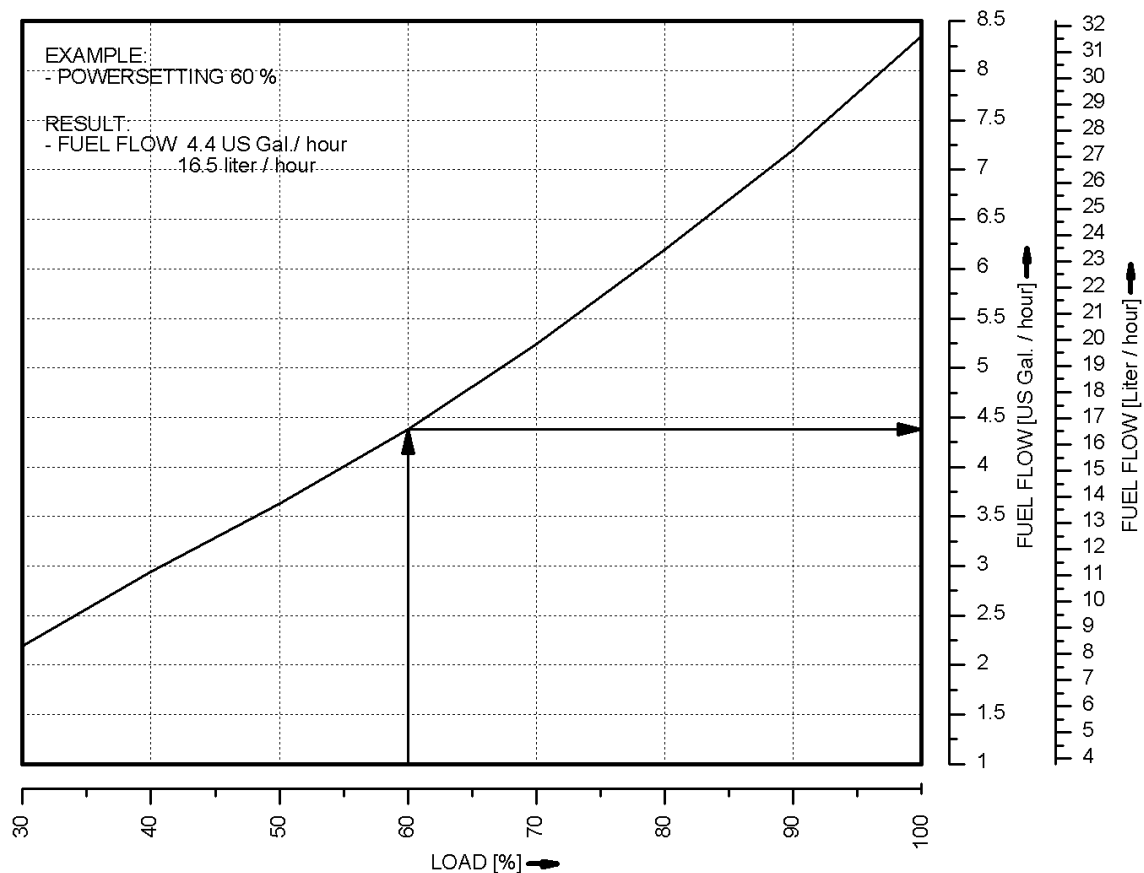

5.3.3 INTERNATIONAL STANDARD ATMOSPHERE

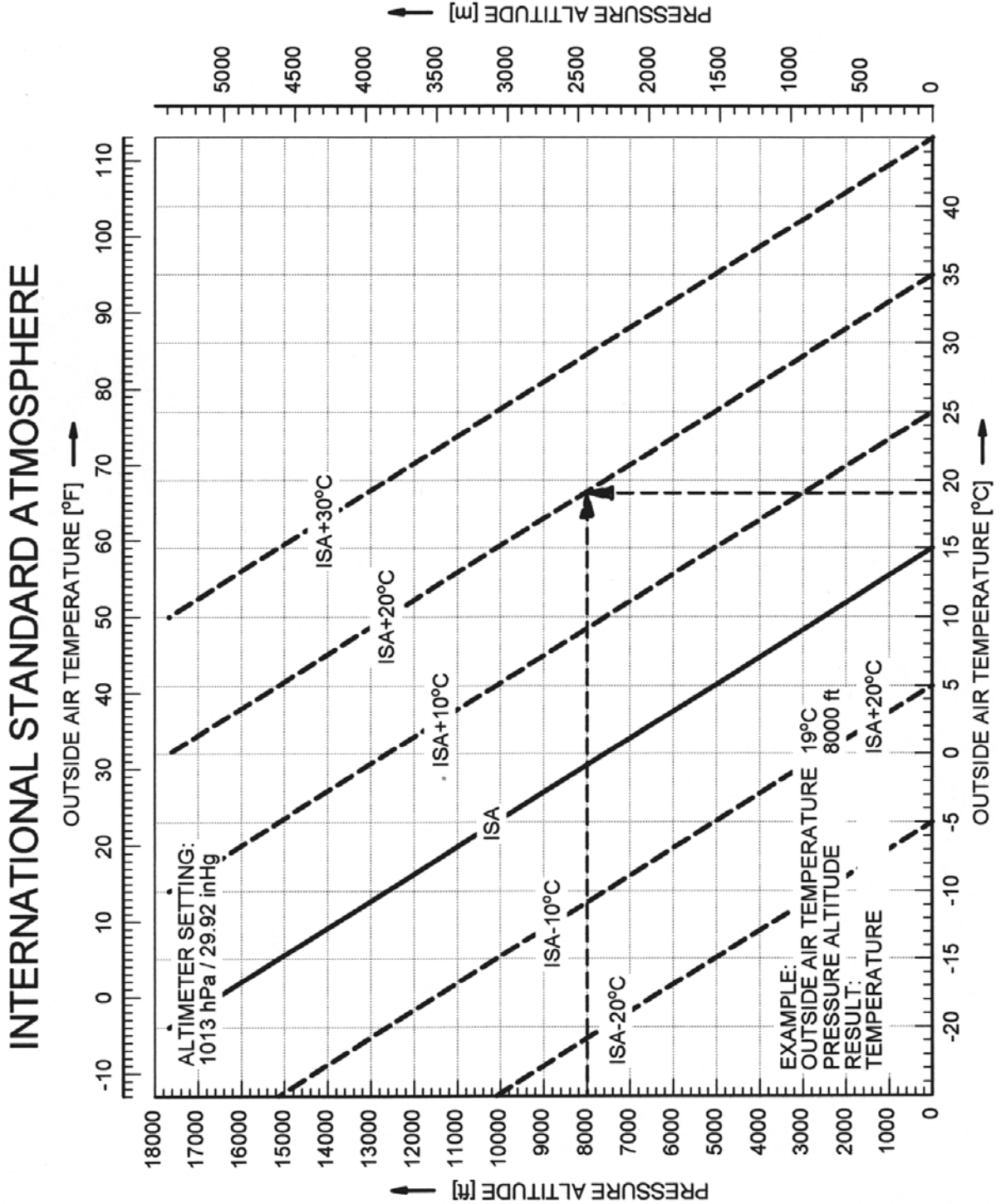

5.3.4 STALLING SPEEDS

CAUTION

The calculated stalling speeds may be higher than the maximum approved / limiting flap-extended and / or maneuvering airspeeds.

Stalling speeds at various flight masses

Airspeeds in KIAS at idle power:

1400 kg (3086 lb)		Bank Angle			
Gear	Flaps	0°	30°	45°	60°
UP	UP	56	60	68	83
DOWN	APP	53	58	65	78
DOWN	LDG	49	53	61	75

1700 kg (3748 lb)		Bank Angle			
Gear	Flaps	0°	30°	45°	60°
UP	UP	62	67	76	92
DOWN	APP	59	64	72	87
DOWN	LDG	55	60	68	84

if MÄM 42-088 is carried out:

1785 kg (3935 lb)		Bank Angle			
Gear	Flaps	0°	30°	45°	60°
UP	UP	64	69	78	95
DOWN	APP	61	66	74	90
DOWN	LDG	57	62	70	86

5.3.5 WIND COMPONENTS

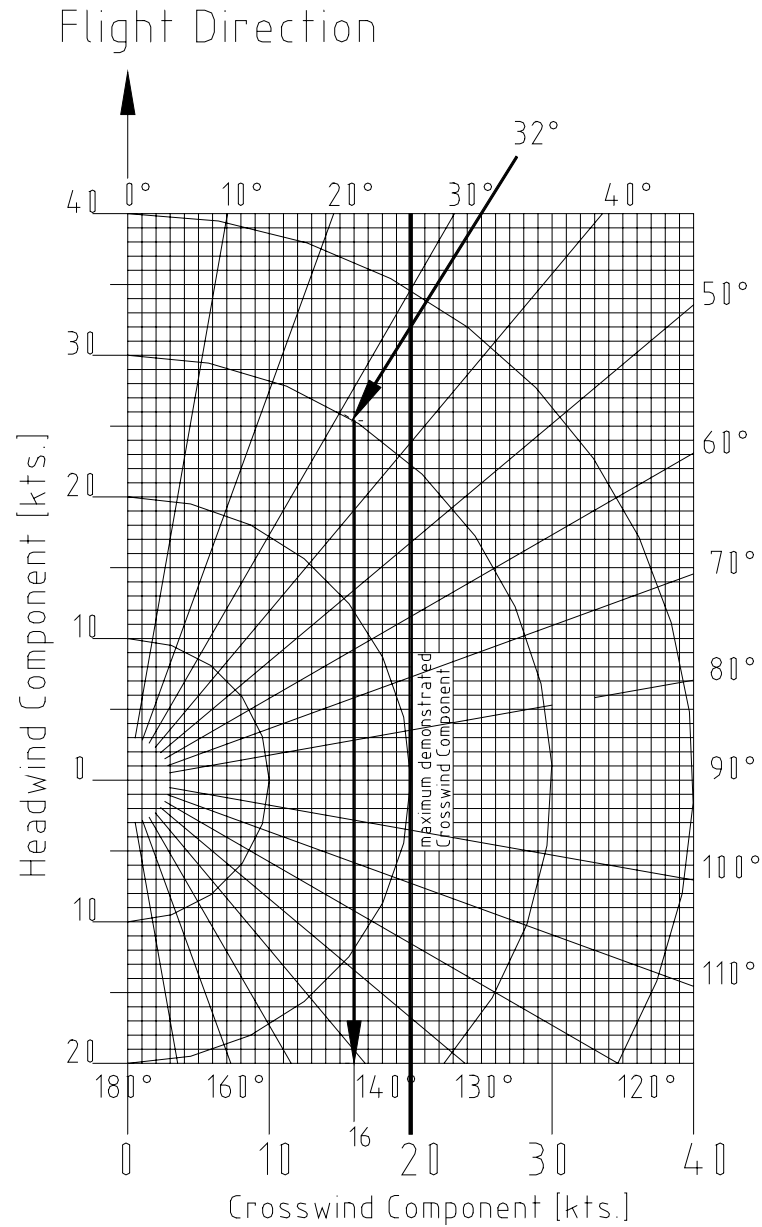

Example: Flight direction : 360°
 Wind : 32°/30 kts
 Result: Crosswind component : 16 kts
 Max. demonstrated crosswind component : 20 kts

5.3.6 TAKE-OFF DISTANCE

Conditions:

- Power lever both MAX @ 2300 RPM
- Flaps UP
- Nose wheel lift-off
 - up to 1700 kg (3748 lb) @ $v_R = 70$ KIAS
 - above 1700 kg (3748 lb) @ $v_R = 72$ KIAS
- Airspeed for initial climb
 - up to 1700 kg (3748 lb) 77 KIAS
 - above 1700 kg (3748 lb) 79 KIAS
- Runway level, hard paved surface
(concrete, asphalt, etc.)

values for ISA and MSL, at 1700 kg (3748 lb)	
Take-off distance over a 50 ft (15 m) obstacle	530 m (1739 ft)
Take-off ground roll	348 m (1142 ft)

if MÄM 42-088 is carried out:

values for ISA and MSL, at 1785 kg (3935 lb)	
Take-off distance over a 50 ft (15 m) obstacle	691 m (2267 ft)
Take-off ground roll	427 m (1401 ft)

WARNING

For a safe take-off the available runway length must be at least equal to the take-off distance over a 50 ft (15 m) obstacle.

WARNING

Poor maintenance condition of the airplane, deviation from the given procedures, uneven runway, as well as unfavorable external factors (high temperature, rain, unfavorable wind conditions, including cross-wind) will increase the take-off distance.

CAUTION

The figures in the following NOTE are typical values. On wet ground or wet soft grass covered runways the take-off roll may become significantly longer than stated below. In any case the pilot must allow for the condition of the runway to ensure a safe take-off.

NOTE

For take-off from dry, short-cut grass covered runways, the following corrections must be taken into account, compared to paved runways (typical values, see CAUTION above):

- grass up to 5 cm (2 in) long: 10 % increase in take-off roll.
- grass 5 to 10 cm (2 to 4 in) long: 15 % increase in take-off roll.
- grass longer than 10 cm (4 in): at least 25 % increase in take-off roll.
- on grass longer than 25 cm (10 in), a take-off should not be attempted.

NOTE

For wet grass, an additional 10 % increase in take-off roll must be expected.

NOTE

An uphill slope of 2 % (2 m per 100 m or 2 ft per 100 ft) results in an increase in the take-off distance of approximately 10 %. The effect on the take-off roll can be greater.

TAKE-OFF DISTANCE OVER 50 ft OBSTACLE

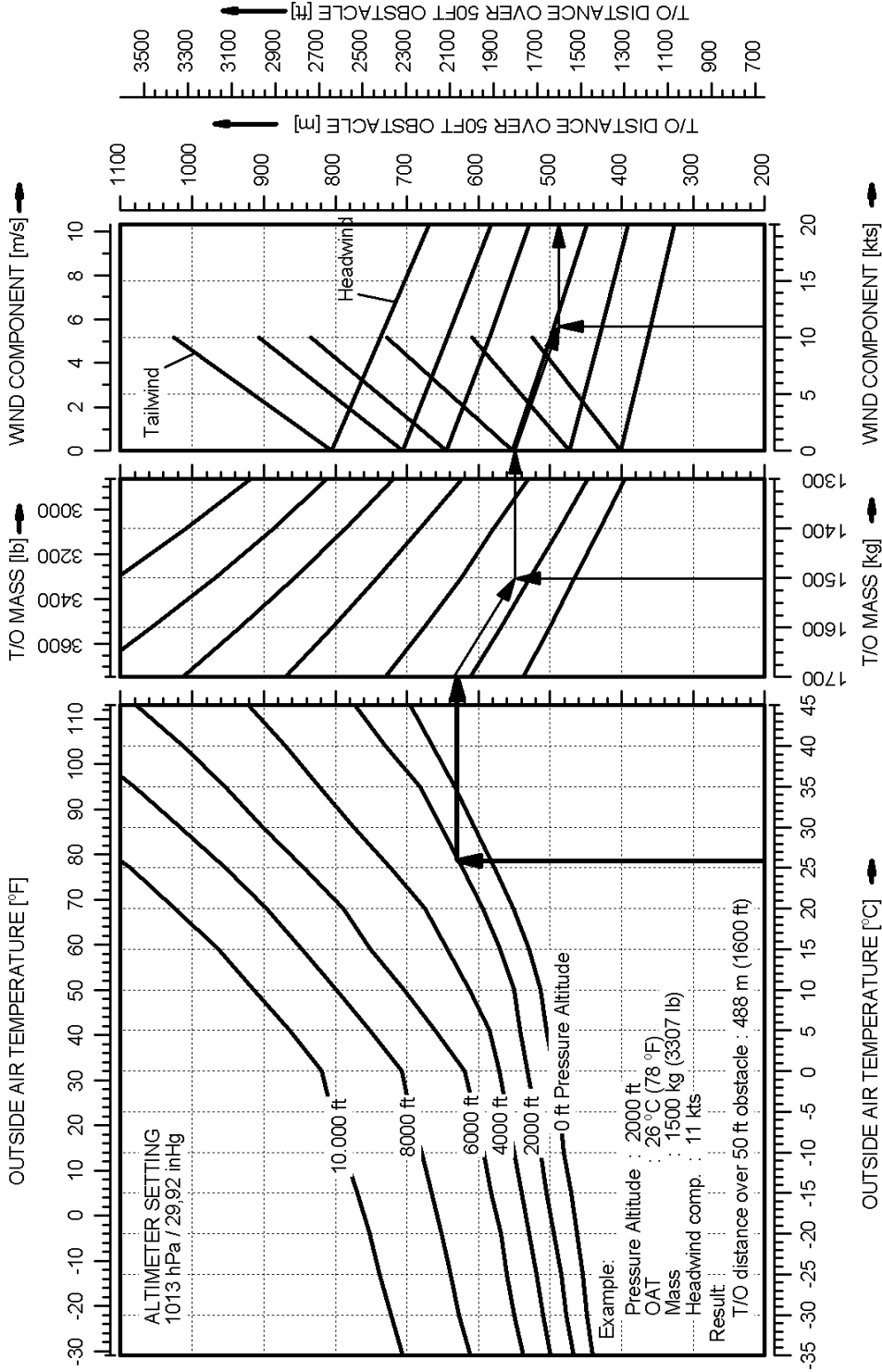

Conditions: Flaps: UP, Power: both MAX @ 2300 RPM, v_R : 70 KIAS, Airspeed: 77 KIAS, Runway: hard, paved

TAKE-OFF DISTANCE OVER 50 ft OBSTACLE (above 1700 kg)

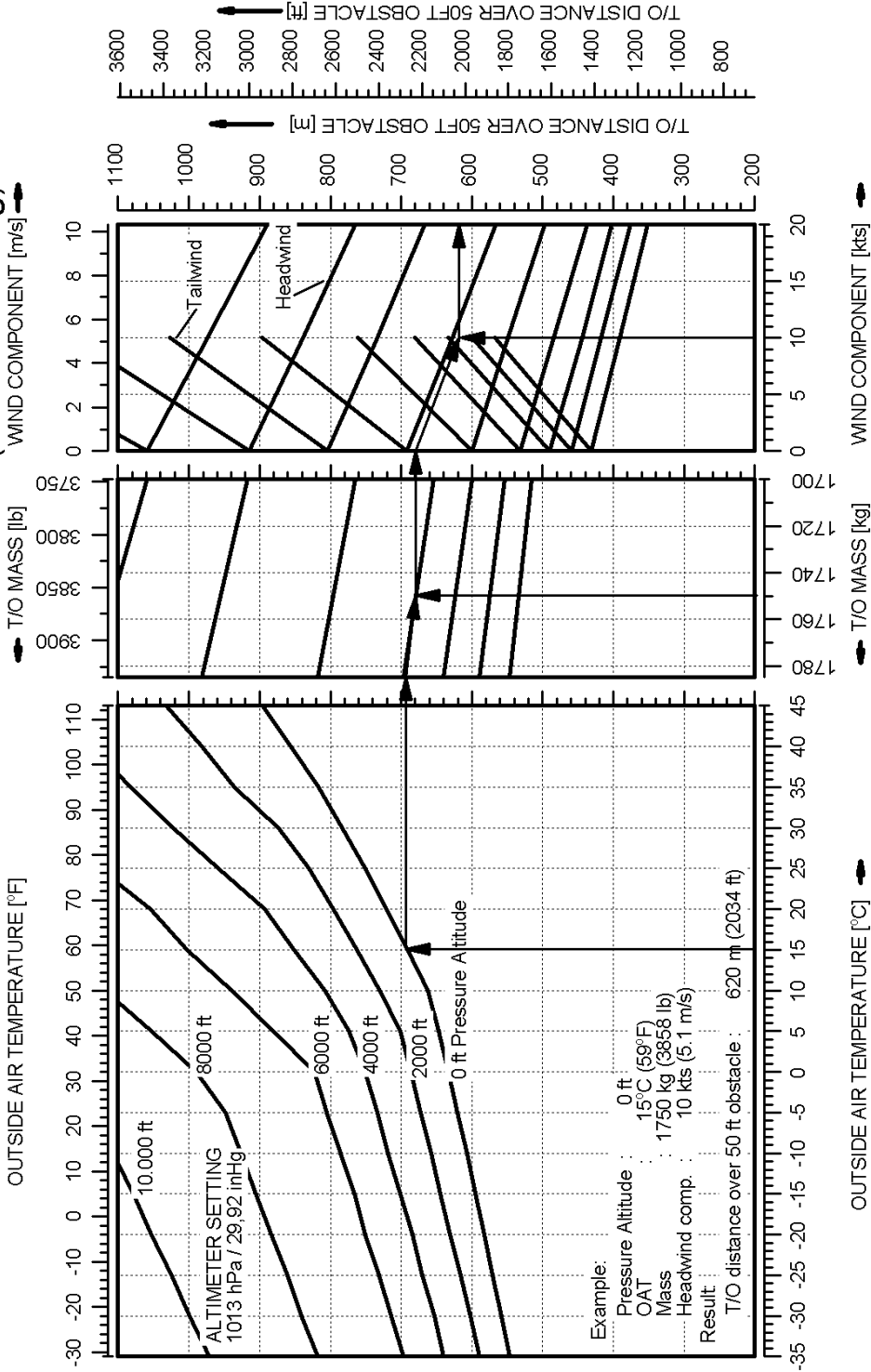

Conditions: Flaps: UP, Power: both MAX @ 2300 RPM, V_R : 72 KIAS, Airspeed: 79 KIAS, Runway: hard, paved

TAKE-OFF GROUND ROLL

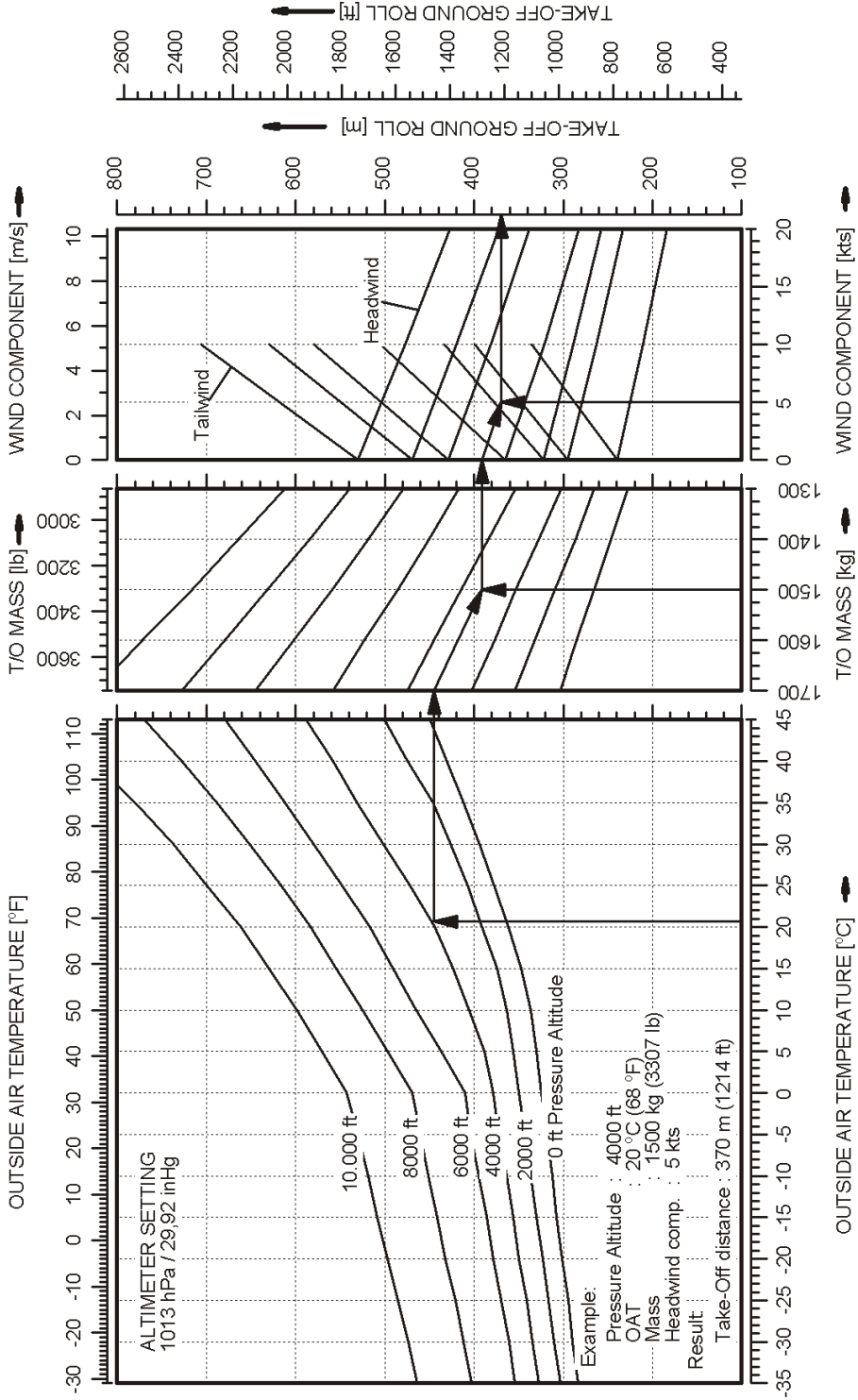

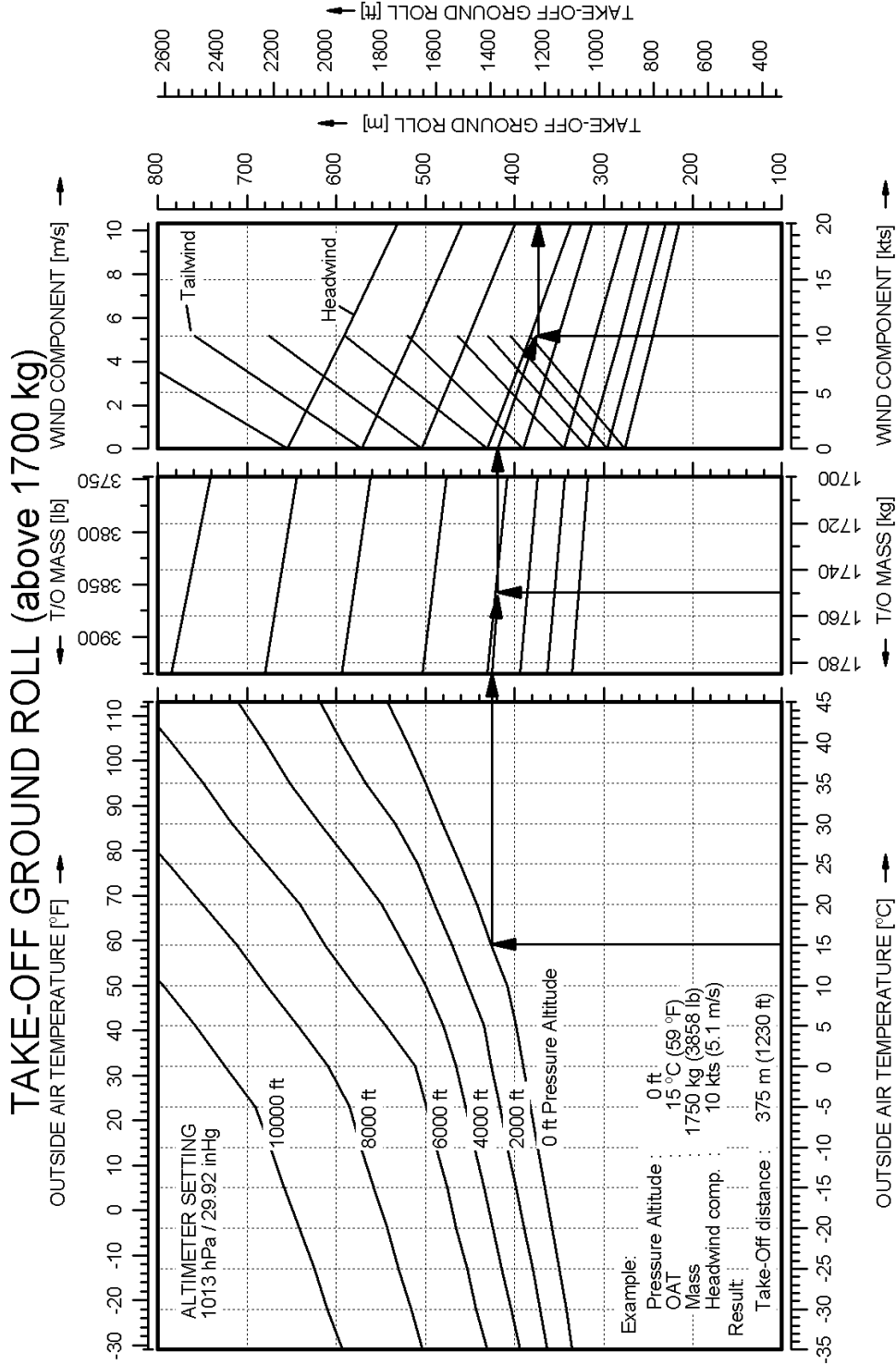

Conditions: Flaps: UP, Power: both MAX @ 2300 RPM, v_R : 72 KIAS, Airspeed: 79 KIAS, Runway: hard, paved

5.3.7 CLIMB PERFORMANCE - TAKE-OFF CLIMB

Conditions:

- Power lever both MAX @ 2300 RPM
- Flaps UP
- Landing Gear retracted
- Airspeed
 - up to 1700 kg (3748 lb) 77 KIAS
 - above 1700 kg (3748 lb) 79 KIAS

NOTE

The charts on the following pages show the *rate* of climb. The *gradient* of climb cannot easily be determined with a chart, but it can be calculated using the following formulae:

$$\text{Gradient [\%]} = \frac{\text{ROC [fpm]}}{\text{TAS [KTAS]}} \cdot 0.95$$

$$\text{Gradient [\%]} = \frac{\text{ROC [m/s]}}{\text{TAS [KTAS]}} \cdot 190$$

CLIMB PERFORMANCE - TAKE-OFF CLIMB

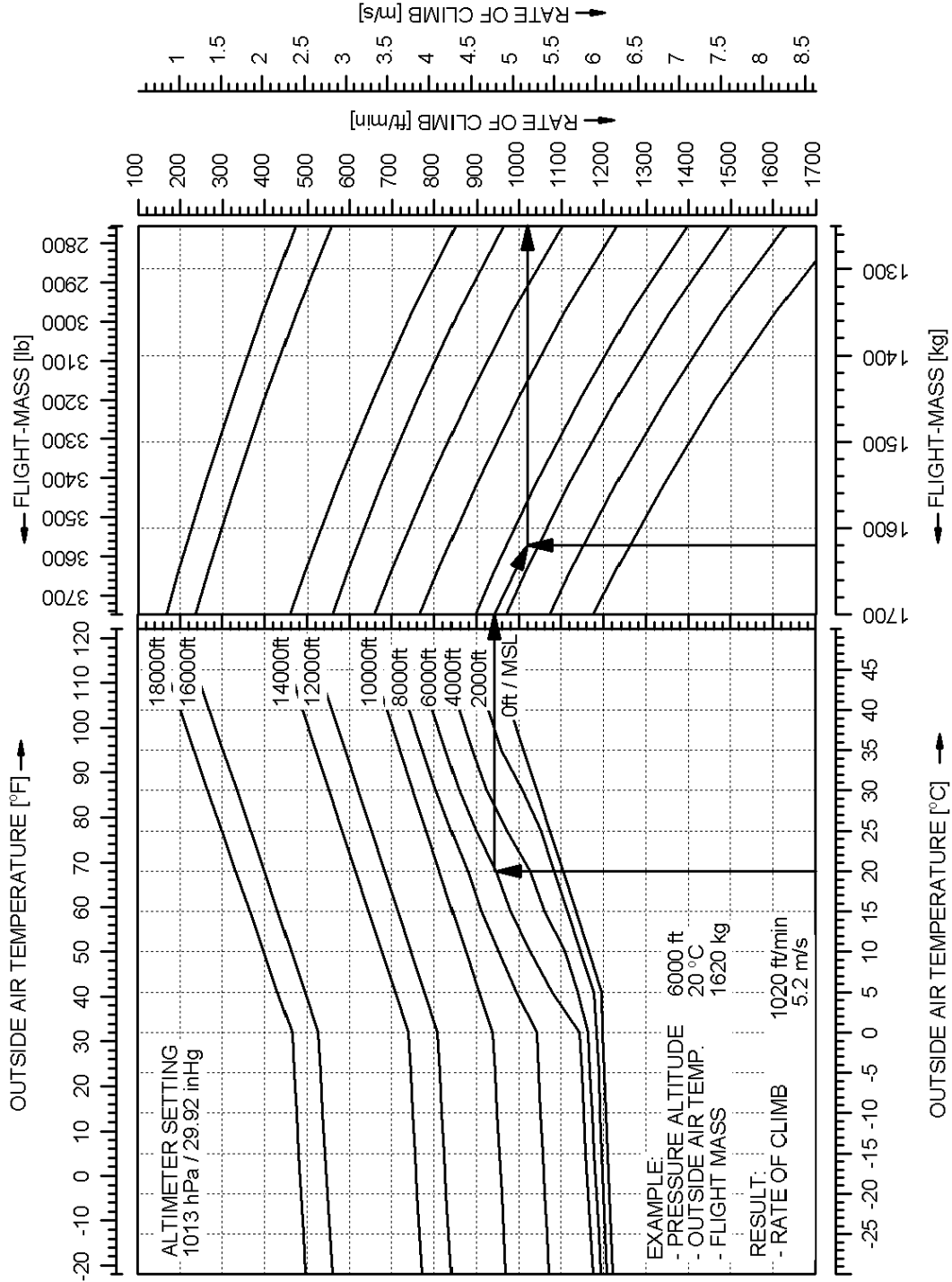

Conditions: Flaps: UP, Power: both MAX @ 2300 RPM, Landing gear: retracted, Airspeed: 77 KIAS

CLIMB PERFORMANCE - TAKE-OFF CLIMB (above 1700 kg)

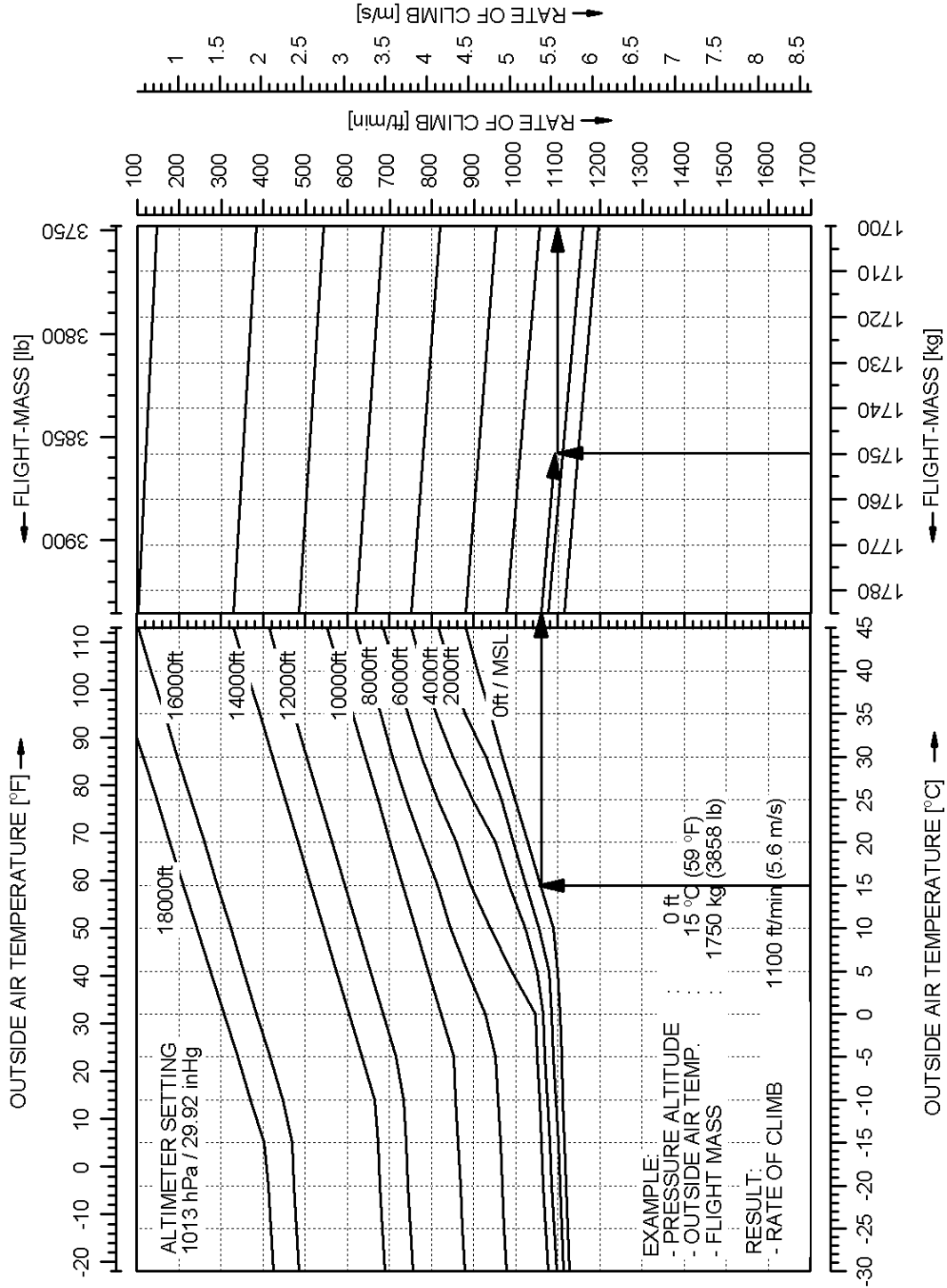

5.3.8 CLIMB PERFORMANCE - CRUISE CLIMB

Conditions:

- Power lever both MAX @ 2300 RPM
- Flaps UP
- Airspeed
 - up to 1700 kg (3748 lb) 85 KIAS
 - above 1700 kg (3748 lb) 86 KIAS

NOTE

The graphs on the following pages show the *rate* of climb. The *gradient* of climb cannot easily be determined with a graph, but it can be calculated using the following formulae:

$$\text{Gradient [\%]} = \frac{\text{ROC [fpm]}}{\text{TAS [KTAS]}} \cdot 0.95$$

$$\text{Gradient [\%]} = \frac{\text{ROC [m/s]}}{\text{TAS [KTAS]}} \cdot 190$$

CLIMB PERFORMANCE - CRUISE CLIMB

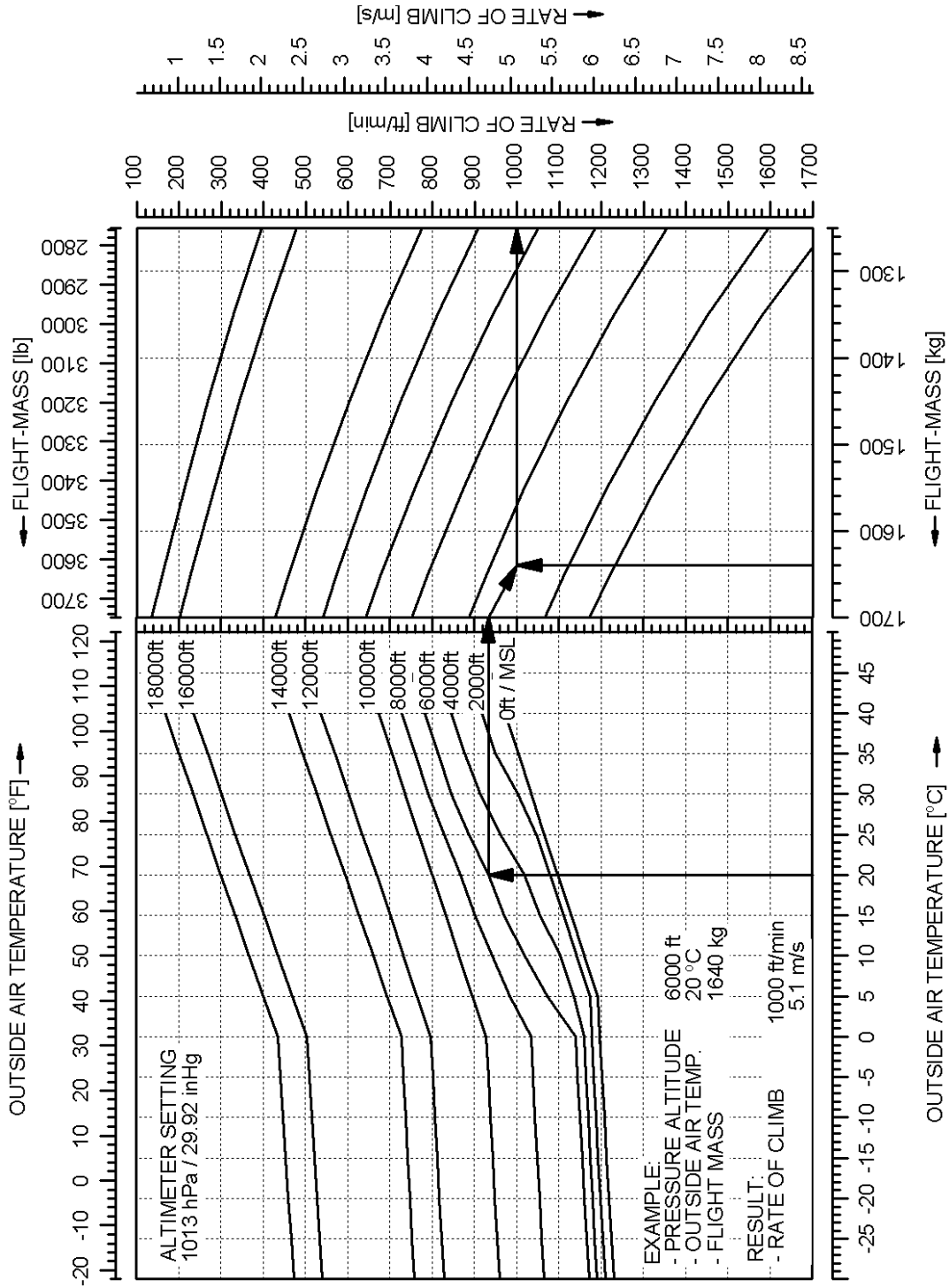

Conditions: Flaps: UP, Power: both MAX @ 2300 RPM, Airspeed: 85 KIAS

CLIMB PERFORMANCE - CRUISE CLIMB (above 1700 kg)

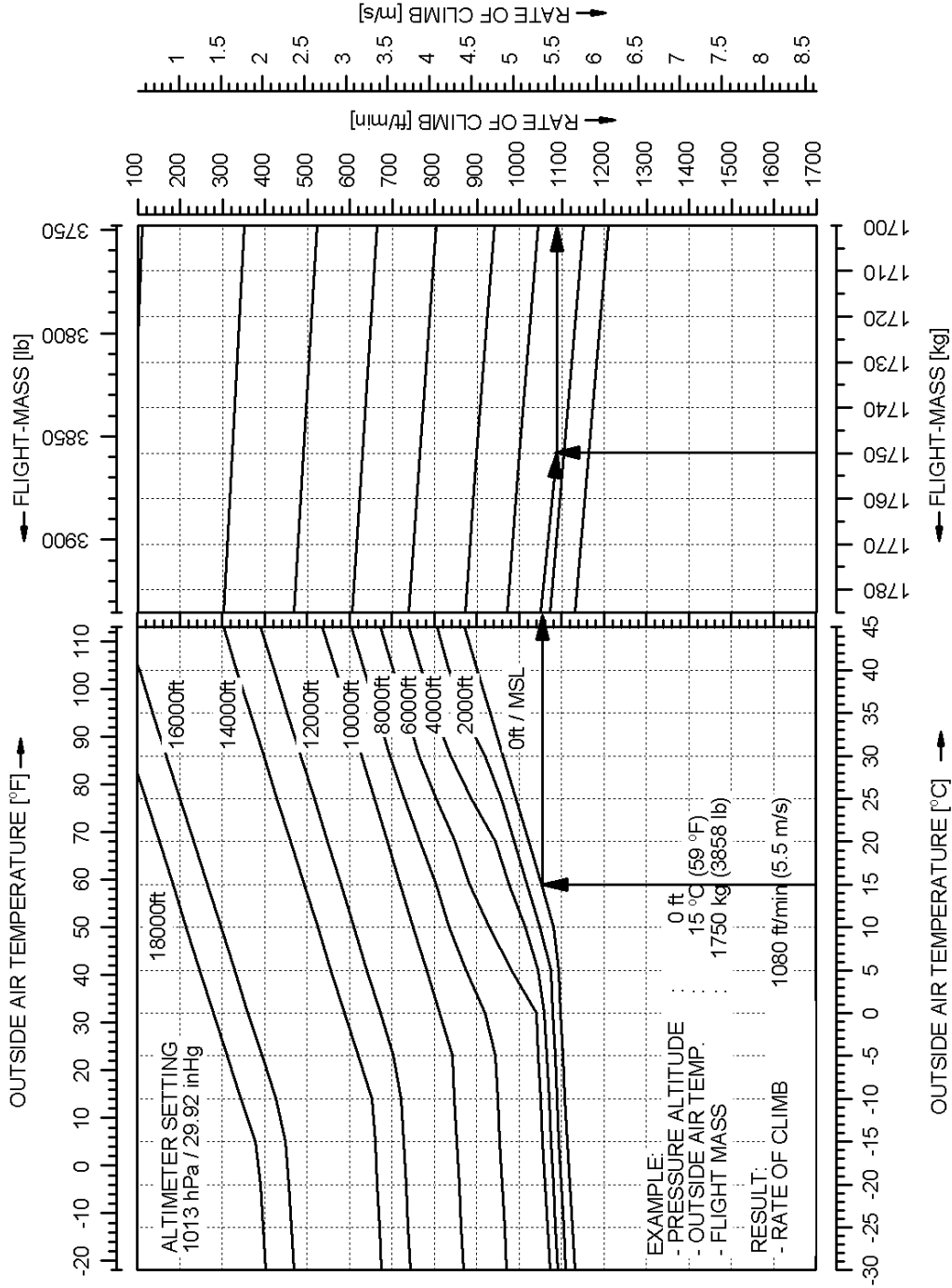

Conditions: Flaps: UP, Power: both MAX @ 2300 RPM, Airspeed: 86 KIAS

5.3.9 ONE ENGINE INOPERATIVE CLIMB PERFORMANCE

Conditions:

- Remaining Engine (RH) MAX @ 2300 RPM
- Dead Engine feathered and secured
- Flaps UP
- Airspeed 82 KIAS
- Landing Gear retracted
- Zero Sideslip established

NOTE

With respect to handling and performance, the left-hand engine (pilots view) is considered the "critical" engine.

NOTE

The graphs on the following pages show the *rate* of climb. The *gradient* of climb cannot easily be determined with a graph, but it can be calculated using the following formulae:

$$\text{Gradient [\%]} = \frac{\text{ROC [fpm]}}{\text{TAS [KTAS]}} \cdot 0.95$$

$$\text{Gradient [\%]} = \frac{\text{ROC [m/s]}}{\text{TAS [KTAS]}} \cdot 190$$

ONE ENGINE INOPERATIVE CLIMB / DESCENT

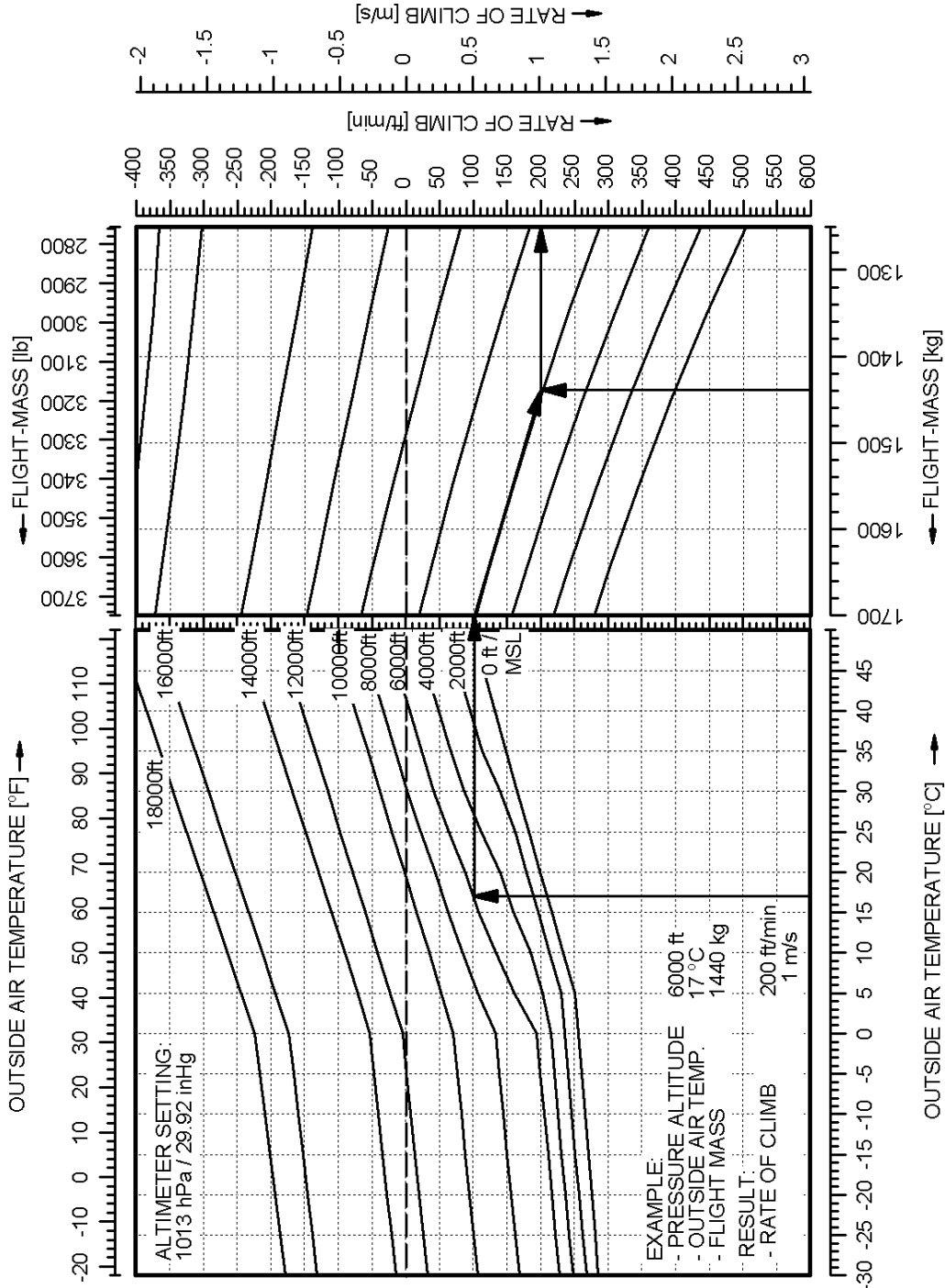

Conditions: Flaps: UP, Power: remaining engine MAX @ 2300 RPM / Dead engine: feathered+secured, Airspeed: 82 KIAS

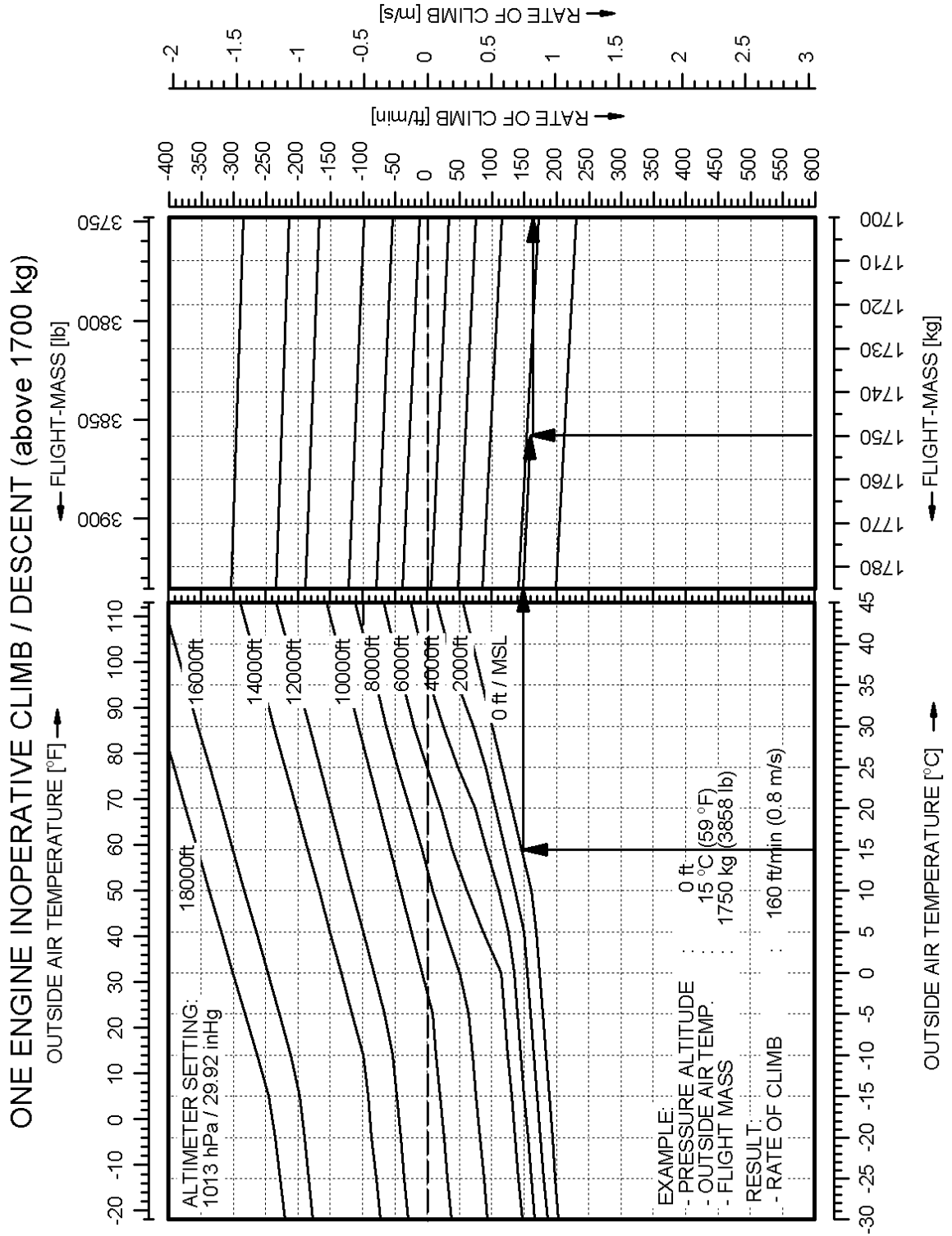

5.3.10 CRUISING (TRUE AIRSPEED TAS)

Conditions:

- Engines all operating
- Power lever as required to adjust selected
displayed LOAD [%]
- Flaps UP
- Landing Gear retracted

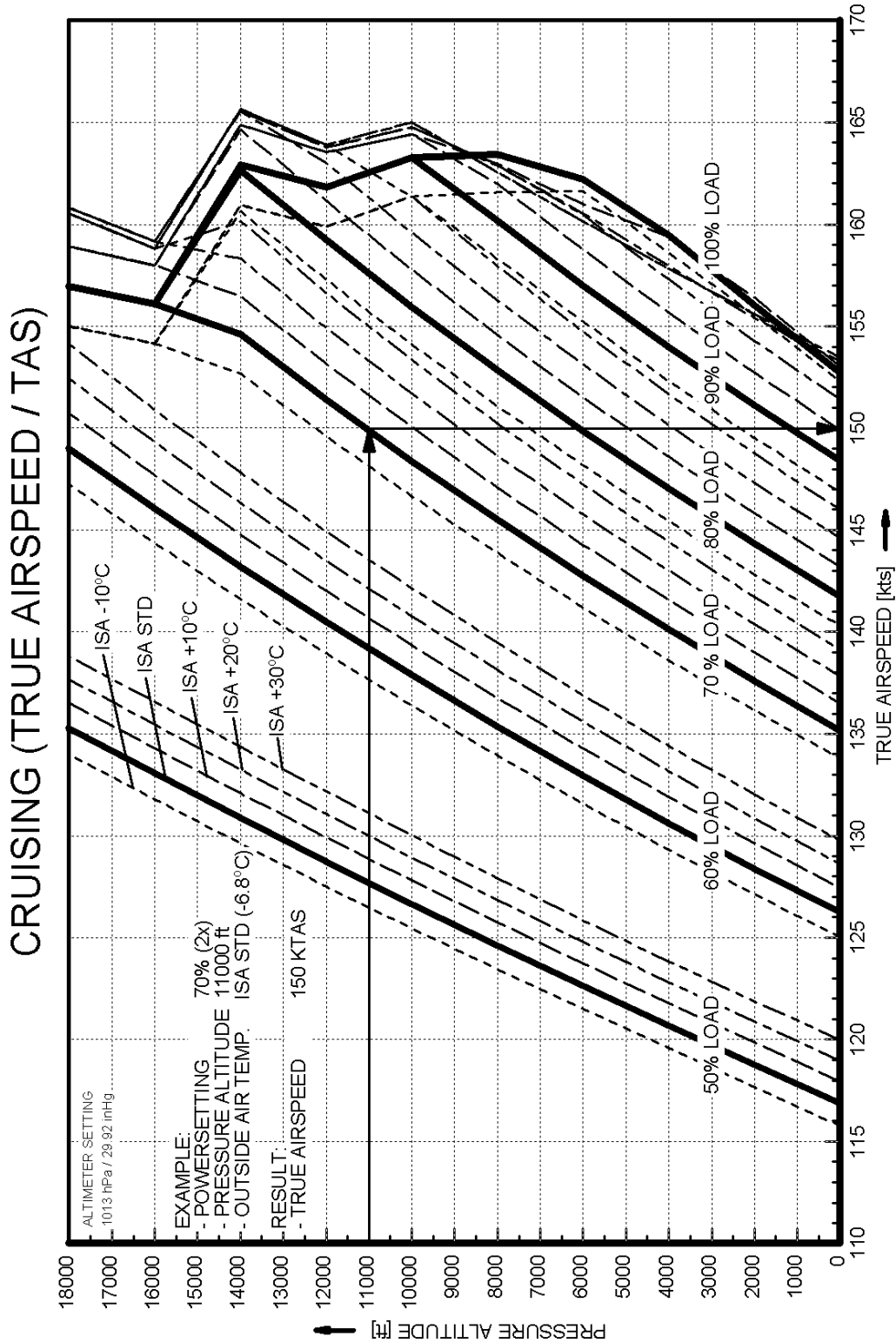

Conditions: Engines: all operating, Power: as required to adjust selected LOAD [%], Flaps: UP, Landing Gear: retracted

5.3.11 LANDING DISTANCE

- Conditions:
- Power lever both IDLE
 - Flaps LDG
 - Runway level, asphalt surface, dry

values for ISA and MSL, at 1700 kg (3748 lb), approach speed 76 KIAS	
Landing distance over a 50 ft (15 m) obstacle	572 m (1877 ft)
Ground roll	323 m (1060 ft)

NOTE

If MÄM 42-088 is carried out, a landing with a mass between 1700 kg (3748 lb) and 1785 kg (3935 lb) is admissible. It constitutes an abnormal operating procedure.

values for ISA and MSL, at 1785 kg (3935 lb), approach speed 78 KIAS	
Landing distance over a 50 ft (15 m) obstacle	710 m (2329 ft)
Ground roll	397 m (1302 ft)

WARNING

For a safe landing the available runway length must be at least equal to the landing distance over a 50 ft (15 m) obstacle.

WARNING

Poor maintenance condition of the airplane, deviation from the given procedures, uneven runway, as well as unfavorable external factors (high temperature, rain, unfavorable wind conditions, including cross-wind) will increase the landing distance.

CAUTION

The figures in the following NOTE are typical values. On wet ground or wet soft grass covered runways the landing distance may become significantly longer than stated below. In any case the pilot must allow for the condition of the runway to ensure a safe landing.

NOTE

For landings on dry, short-cut grass covered runways, the following corrections must be taken into account, compared to paved runways (typical values, see CAUTION above):

- grass up to 5 cm (2 in) long: 5 % increase in landing roll.
- grass 5 to 10 cm (2 to 4 in) long: 15 % increase in landing roll.
- grass longer than 10 cm (4 in): at least 25 % increase in landing roll.

NOTE

For wet grass, an additional 10 % increase in landing roll must be expected.

NOTE

A downhill slope of 2 % (2 m per 100 m or 2 ft per 100 ft) results in an increase in the landing distance of approximately 10 %. The effect on the landing roll can be greater.

LANDING DISTANCE OVER 15 m (50 ft) OBSTACLE

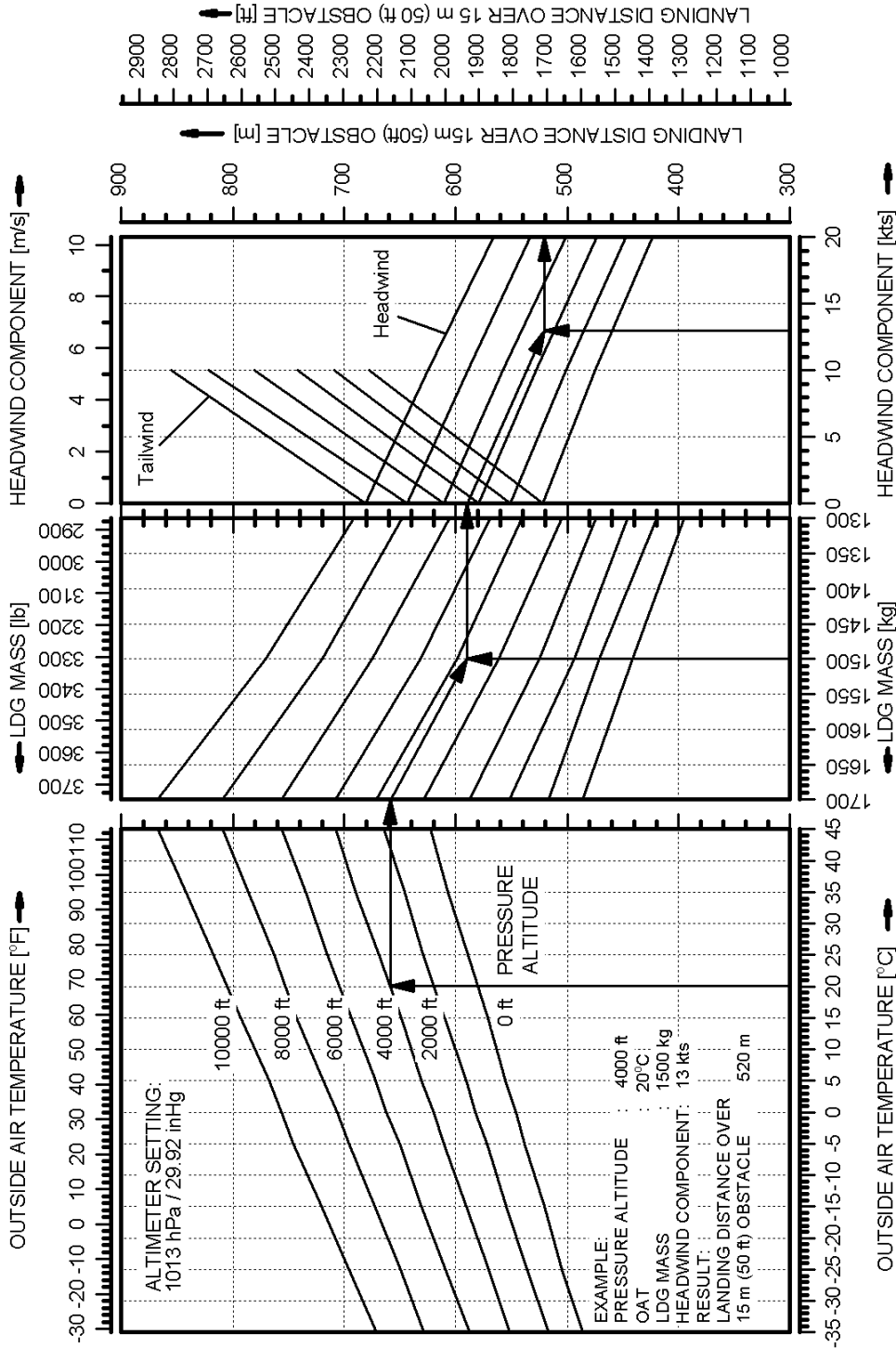

Conditions: Flaps: LDG, Power: both IDLE, Runway: level and hard, dry surface, Approach Speed: 76 KIAS

LANDING DISTANCE OVER 15m (50 ft) OBSTACLE (above 1700 kg)

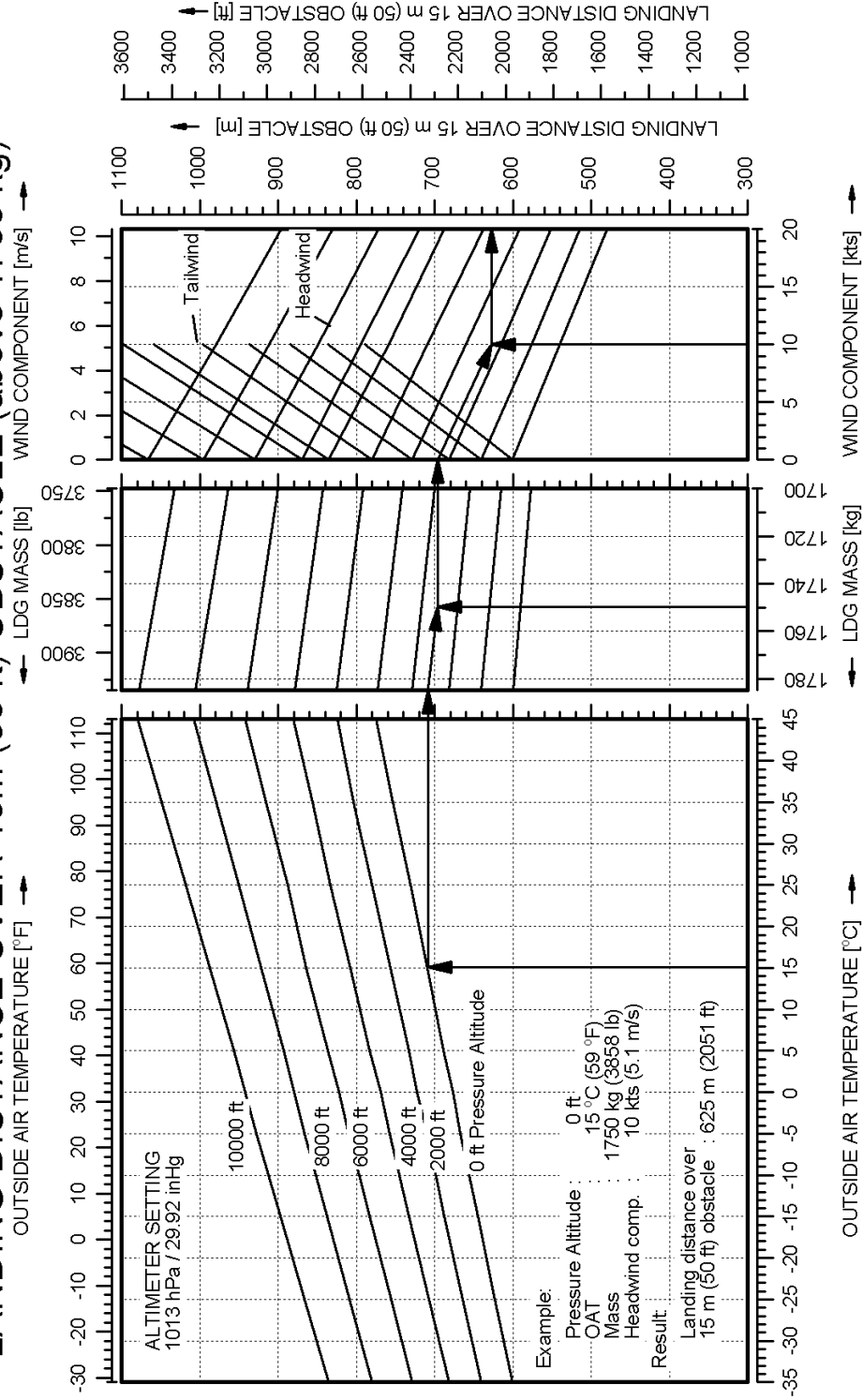

Conditions: Flaps: LDG, Power : both IDLE, Runway: level and hard, dry surface, Approach Speed: 78 KIAS

LANDING DISTANCE GROUND ROLL

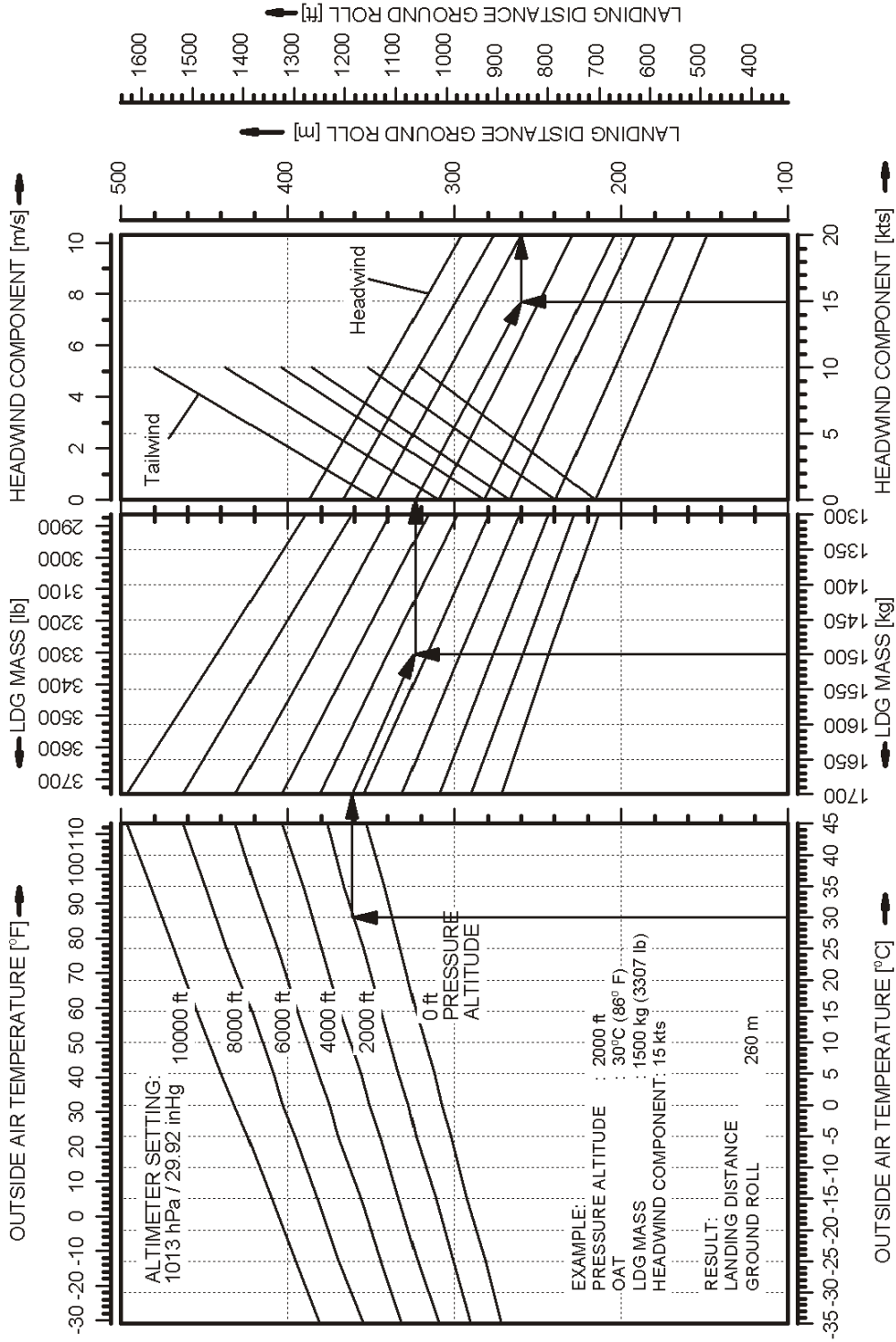

Conditions: Flaps: LDG, Power: both IDLE, Runway: level and hard, dry surface, Approach Speed: 76 KIAS

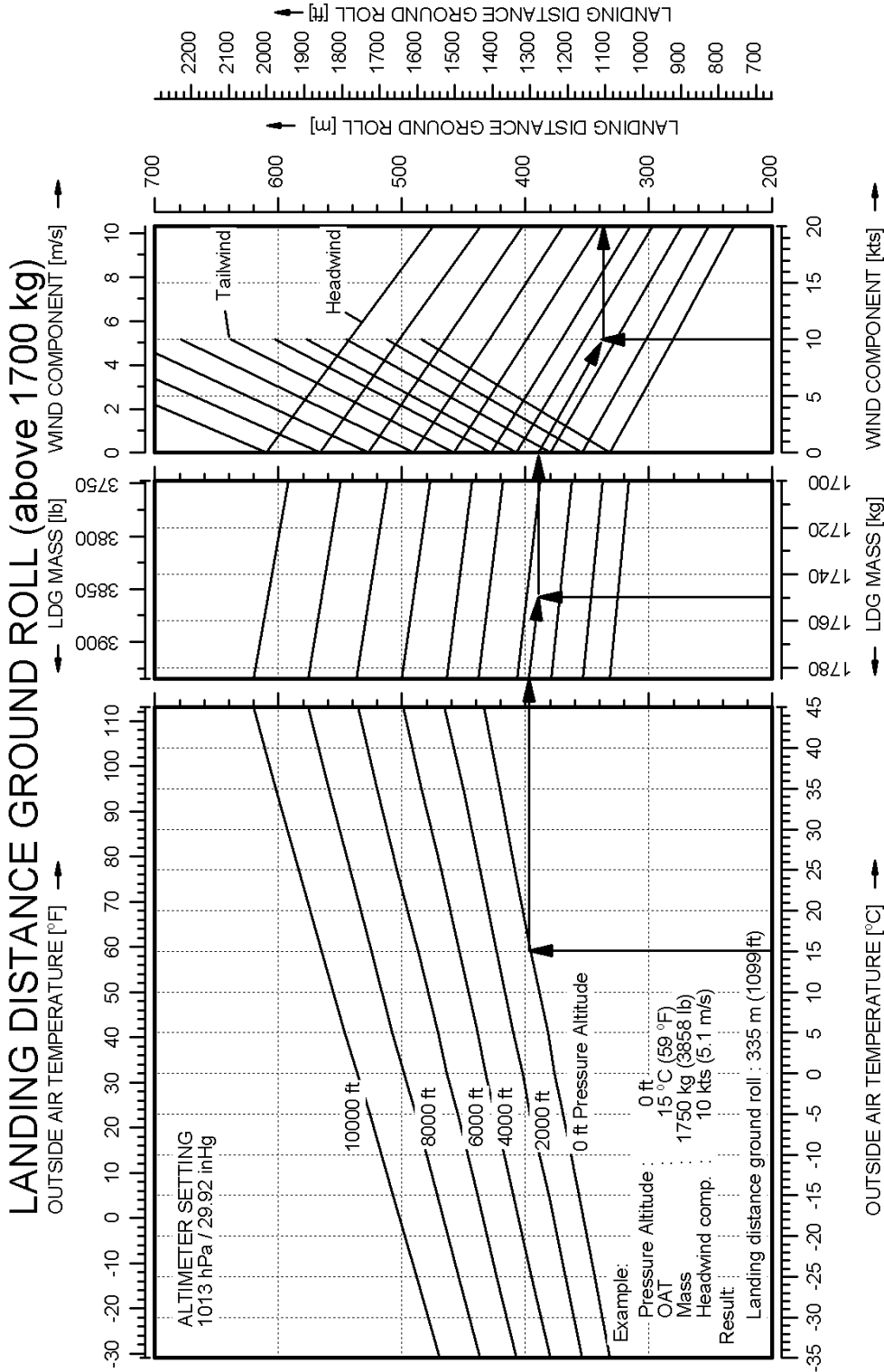

Conditions: Flaps: LDG, Power: both IDLE, Runway: level and hard, dry surface, Approach Speed: 78 KIAS

5.3.12 GRADIENT OF CLIMB ON GO-AROUND

Conditions:

- Power lever both MAX @ 2300 RPM
- Flaps LDG
- Landing gear extended
- Airspeed:
 - up to 1700 kg (3748 lb) 76 KIAS
 - above 1700 kg (3748 lb) 78 KIAS

value for ISA and MSL, at 1700 kg (3748 lb)	
Constant gradient of climb	5.25 % (equals 3.0° climb angle) or 400 ft/min

NOTE

If MÄM 42-088 is carried out, a landing with a mass between 1700 kg (3748 lb) and 1785 kg (3935 lb) is admissible. It constitutes an abnormal operating procedure.

value for ISA and MSL, at 1785 kg (3935 lb)	
Constant gradient of climb	4.30 % (equals 2.5° climb angle) or 340 ft/min

5.3.13 APPROVED NOISE DATA

Max. flight mass 1700 kg (3748 lb)

ICAO Annex 16 Chapter X, App. 6 75.2 dB(A)

JAR-36 Subpart C 75.2 dB(A)

Max. flight mass 1785 kg (3935 lb), if MÄM 42-088 is carried out

ICAO Annex 16 Chapter X, App. 6 76.8 dB(A)

JAR-36 Subpart C 76.8 dB(A)

■ Max. flight mass 1700 kg (3748 lb), if MÄM 42-198 is carried out

■ ICAO Annex 16 Chapter X, App.6 77.6 dB(A)

■ JAR-36 Subpart C 77.6 dB(A)

■ Max. flight mass 1785 kg (3935 lb), if MÄM 42-088 and MÄM 42-198 are carried out

■ ICAO Annex 16 Chapter X, App.6 79.1 dB(A)

■ JAR-36 Subpart C 79.1 dB(A)

Intentionally left blank.

CHAPTER 6

MASS AND BALANCE

	Page
6.1 INTRODUCTION	6-2
6.2 DATUM PLANE	6-3
6.3 MASS AND BALANCE REPORT	6-4
6.4 FLIGHT MASS AND CENTER OF GRAVITY	6-6
6.4.1 MOMENT ARMS	6-8
6.4.2 LOADING DIAGRAM	6-9
6.4.3 CALCULATION OF LOADING CONDITION	6-10
6.4.4 PERMISSIBLE CENTER OF GRAVITY RANGE	6-12
6.4.5 PERMISSIBLE MOMENT RANGE	6-14
6.5 EQUIPMENT LIST AND EQUIPMENT INVENTORY	6-15

6.1 INTRODUCTION

In order to achieve the performance and flight characteristics described in this Airplane Flight Manual and for safe flight operation, the airplane must be operated within the permissible mass and balance envelope.

The pilot is responsible for adhering to the permissible values for loading and center of gravity (CG). In this, he should note the movement of the CG due to fuel consumption. The permissible CG range during flight is given in Chapter 2.

The procedure for determining the flight mass CG position is described in this chapter. Additionally a comprehensive list of the equipment approved for this airplane exists (Equipment List). The set of items marked as 'installed' constitutes the *Equipment Inventory*.

Before the airplane is delivered, the empty mass and the corresponding CG position are determined and entered in Section 6.3 MASS AND BALANCE REPORT.

NOTE

Following equipment changes the new empty mass and the corresponding CG position must be determined by calculation or by weighing.

Following repairs or repainting the new empty mass and the corresponding CG position must be determined by weighing.

Empty mass, empty mass CG position, and the empty mass moment must be certified in the Mass and Balance Report by authorized personnel.

NOTE

Refer to Section 1.6 UNITS OF MEASUREMENT for conversion of SI units to US units and vice versa.

6.2 DATUM PLANE

The Datum Plane (DP) is a plane which is normal to the airplane's longitudinal axis and in front of the airplane as seen from the direction of flight. The airplane's longitudinal axis is parallel with the floor of the nose baggage compartment. When the floor of the nose baggage compartment is aligned horizontally, the Datum Plane is vertical. The Datum Plane is located 2.196 meters (86.46 in) forward of the most forward point of the root rib on the stub wing.

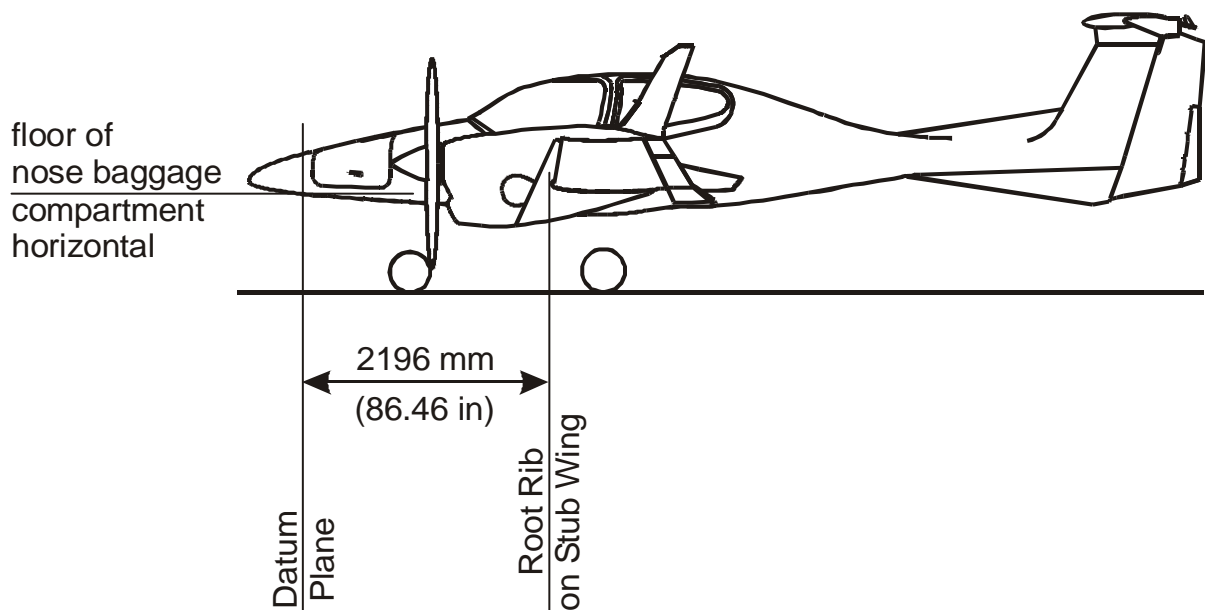

6.3 MASS AND BALANCE REPORT

The empty mass and the corresponding CG position established before delivery are the first entries in the Mass and Balance Report. Every change in permanently installed equipment, and every repair to the airplane which affects the empty mass or the empty mass CG must be recorded in the Mass and Balance Report.

For the calculation of flight mass and corresponding CG position (or moment), the *current* empty mass and the corresponding CG position (or moment) in accordance with the Mass and Balance Report must always be used.

Condition of the airplane for establishing the empty mass:

- Equipment as per Equipment Inventory (see Section 6.5)
- Including the following operating fluids:
 - brake fluid
 - hydraulic fluid (for the retractable gear)
 - engine oil (2 x 6.0 liters = 2 x 6.3 qts)
 - coolant (2 x 6.0 liters = 2 x 6.3 qts)
 - gearbox oil (2 x 0.9 liters = 2 x 0.95 qts)
 - unusable fuel in main fuel tanks (2 x 1.0 US gal = 2 x 3.8 liters)
 - unusable fuel in auxiliary fuel tanks (if installed, 2 x 0.5 US gal = 2 x 1.9 liters)

6.4 FLIGHT MASS AND CENTER OF GRAVITY

The following information enables you to operate your DA 42 within the permissible mass and balance limits. For the calculation of the flight mass and the corresponding CG position the following tables and diagrams are required:

6.4.1 MOMENT ARMS

6.4.2 LOADING DIAGRAM

6.4.3 CALCULATION OF LOADING CONDITION

6.4.4 PERMISSIBLE CENTER OF GRAVITY RANGE

6.4.5 PERMISSIBLE MOMENT RANGE

The diagrams should be used as follows:

1. Take the empty mass and the empty mass moment of your airplane from the Mass and Balance Report, and enter the figures in the appropriate boxes under the column marked 'Your DA 42' in Table 6.4.3 - 'CALCULATION OF LOADING CONDITION'.
2. Read the fuel quantity indicators to determine the fuel quantity in the main fuel tanks.
3. Determine the fuel quantity in the auxiliary fuel tanks (if installed).

To verify an empty auxiliary fuel tank, set the ELECT. MASTER switch and the FUEL TRANSFER switch to ON and check the PFD for the L/R AUX FUEL E caution message.

To verify a full auxiliary fuel tank open the auxiliary fuel tank filler and check fuel level.

If the auxiliary fuel tank quantity is in between empty and full, the exact quantity cannot be determined. If possible transfer all fuel to the main fuel tank by setting the ELECT. MASTER switch and the FUEL TRANSFER switch to ON until the L/R AUX FUEL E caution message appears on the PFD. During this procedure ground power must be used or at least one engine must be running. The fuel transfer will take a maximum of 10 minutes.

CAUTION

If the auxiliary tanks are in use, both tanks must be refueled to the maximum level to provide proper information for the pilot about the fuel quantity in the auxiliary fuel tanks.

If the auxiliary tanks are not in use, the pilot must ensure that they are empty.

4. Multiply the individual masses by the moment arms quoted to obtain the moment for every item of loading and enter these moments in the appropriate boxes in Table 6.4.3 - 'CALCULATION OF LOADING CONDITION'.
5. Add up the masses and moments in the respective columns. The CG position is calculated by dividing the total moment by the total mass (using row 8 for the condition with empty fuel tanks, and row 11 for the pre take-off condition). The resulting CG position must be inside the limits.

As an illustration the total mass and the CG position are entered on Diagram 6.4.4 - 'PERMISSIBLE CENTER OF GRAVITY RANGE'. This checks graphically that the current configuration of the airplane is within the permissible range.

6. Graphical method:

Diagram 6.4.2 - 'LOADING DIAGRAM' is used to determine the moments. The masses and moments for the individual items of loading are added. Then Diagram 6.4.5 - 'PERMISSIBLE MOMENT RANGE' is used to check whether the total moment associated with the total mass is in the permissible range.

The result found with the graphical method is however inaccurate. In doubtful cases the result must be verified using the exact method given above.

6.4.1 MOMENT ARMS

The most important lever arms aft of the Datum Plane:

Item		Lever Arm	
		[m]	[in]
Occupants on front seats		2.30	90.6
Occupants on rear seats		3.25	128.0
Fuel	in main tanks	2.63	103.5
	in auxiliary tanks	3.20	126.0
De-icing Fluid (if equipment installed, OÄM 42-053 or OÄM 42-054)		1.00	39.4
Baggage in Compartments	nose	0.60	23.6
	cabin	3.89	153.1
	extension	4.54	178.7

6.4.2 LOADING DIAGRAM

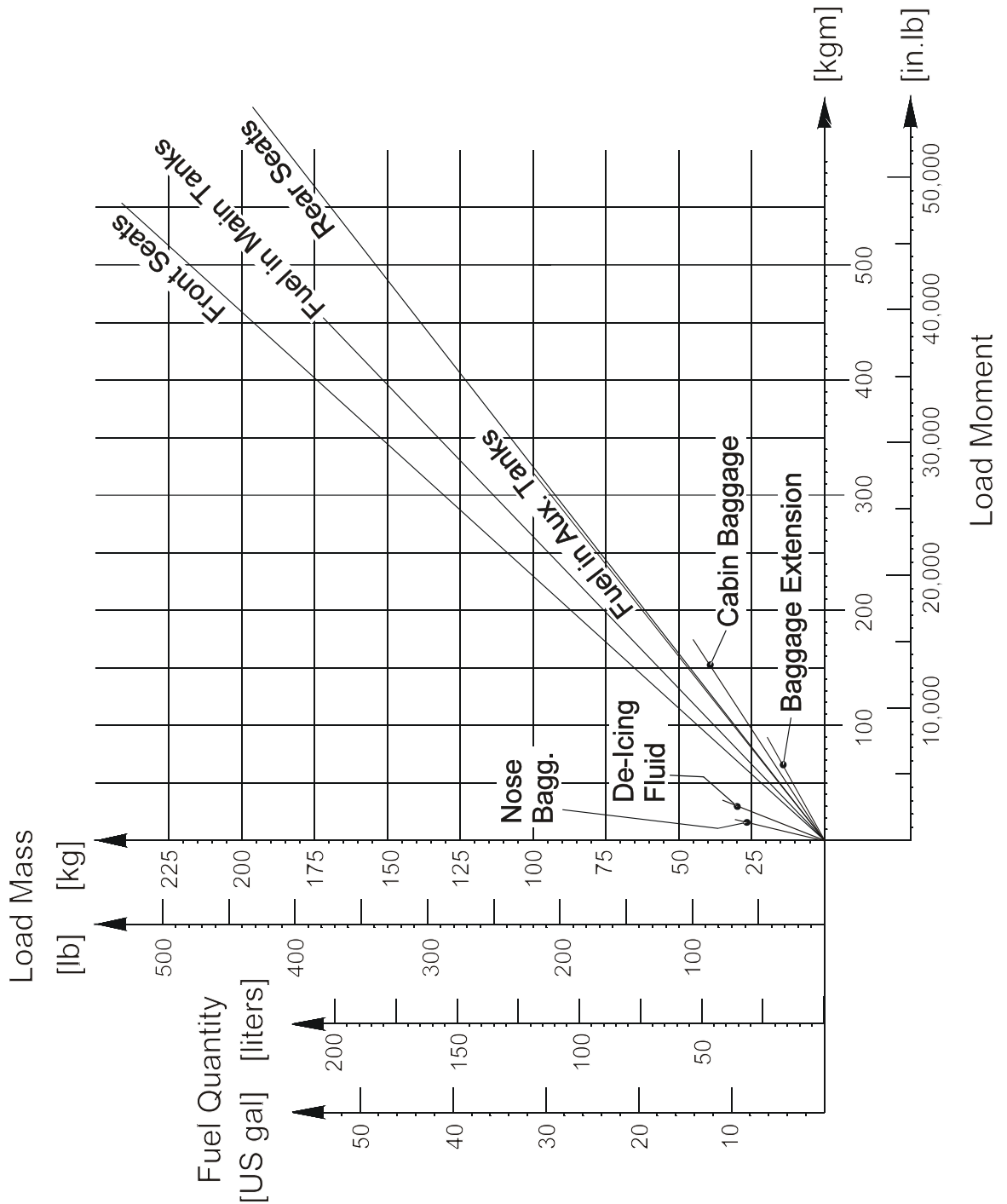

CALCULATION OF LOADING CONDITION	DA 42 (Example)		Your DA 42	
	Mass	Moment	Mass	Moment
	[kg] [lb]	[kgm] [in.lb]	[kg] [lb]	[kgm] [in.lb]
1. Empty mass (from Mass and Balance Report)	1250 2756	2937.5 254,965		
2. Front seats Lever arm: 2.30 m (90.6 in)	160 353	368.0 31,982		
3. Rear seats Lever arm: 3.25 m (128.0 in)	70 154	227.5 19,712		
4. Nose baggage compt. Lever arm: 0.60 m (23.6 in)	5 11	3.0 260		
5. Cabin baggage compt. Lever arm: 3.89 m (153.1 in)	10 22	38.9 3,368		
6. Baggage extension Lever arm: 4.54 m (178.7 in)	5 11	22.7 1,966		
7. De-icing fluid (if installed; see NOTE on previous page) (1.1 kg/liter) (9.2 lb/US gal) Lever arm: 1.00 m (39.4 in)	27.5 61	27.5 2,403		
8. Total mass & total moment with empty fuel tanks (Total of 1. through 7.)	1527.5 3368	3625.1 314,656		
9. Usable fuel, main tanks (0.84 kg/liter) (7.01 lb/US gal) Lever arm: 2.63 m (103.5 in)	159 351	418.2 36,329		
10. Usable fuel, auxiliary tanks (if installed; OAM 42-056) (0.84 kg/liter) (7.01 lb/US gal) Lever arm: 3.20 m (126.0 in)	84 185	268.8 23,310		
11. Total mass & total moment with fuel & de-icing fluid (Total of 8. through 10.)	1770.5 3904	4312.1 374,295		

The CG's shown in the following diagrams are those from the example in Section 6.4.3 'CALCULATION OF LOADING CONDITION', rows 8 and 11.

6.4.4 PERMISSIBLE CENTER OF GRAVITY RANGE

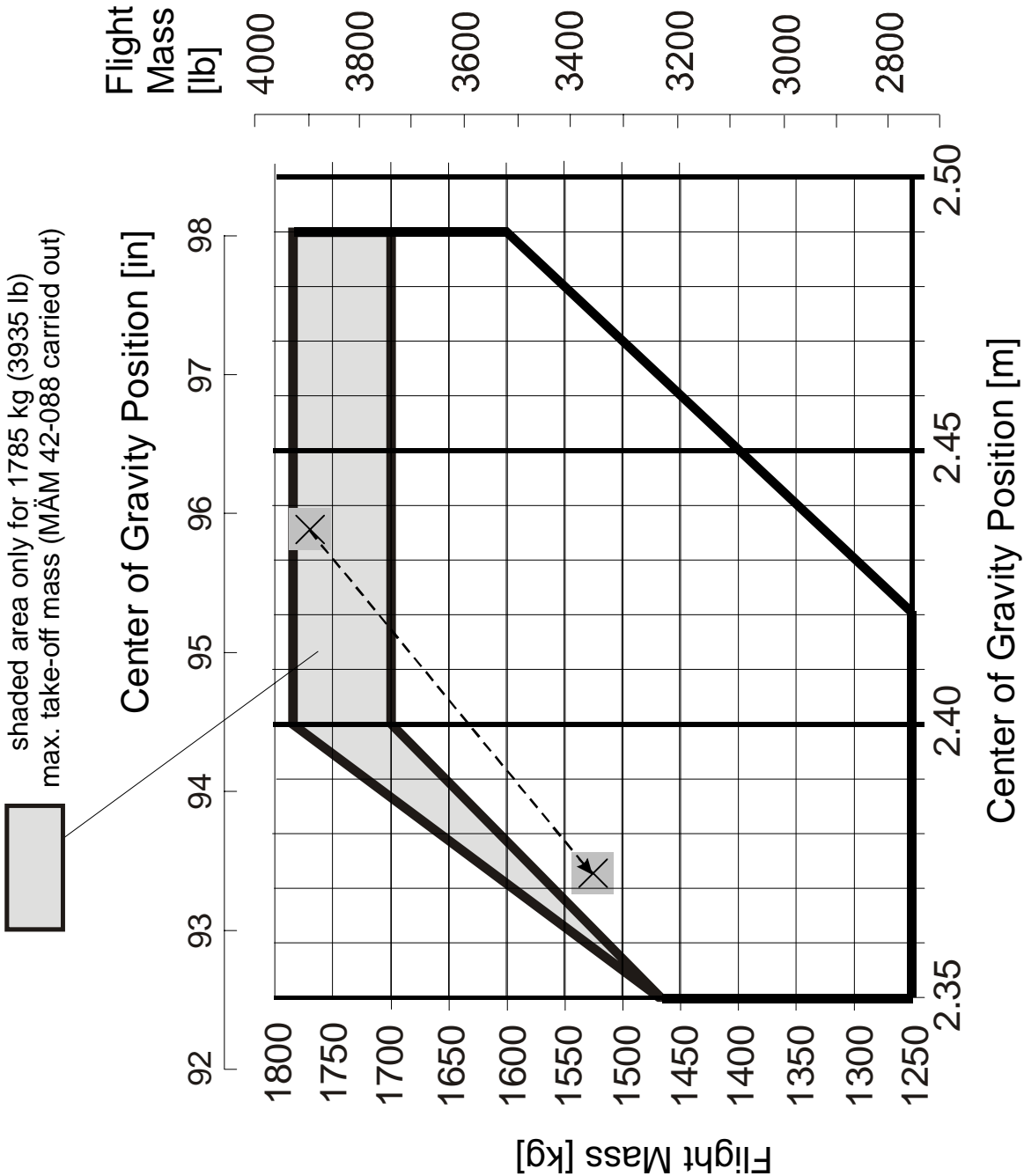

The flight CG position must be within the following limits:

Most forward flight CG:

2.35 m (92.52 in) aft of Datum Plane at 1250 kg (2756 lb)

2.35 m (92.52 in) aft of Datum Plane at 1468 kg (3236 lb)

2.40 m (94.49 in) aft of Datum Plane at max. take off mass (see Section 2.7)
linear variation in between

Most rearward flight CG:

2.42 m (95.28 in) aft of Datum Plane at 1250 kg (2756 lb)

2.49 m (98.03 in) aft of Datum Plane at 1600 kg (3527 lb)

2.49 m (98.03 in) aft of Datum Plane at max. take off mass (see Section 2.7)
linear variation in between

6.4.5 PERMISSIBLE MOMENT RANGE

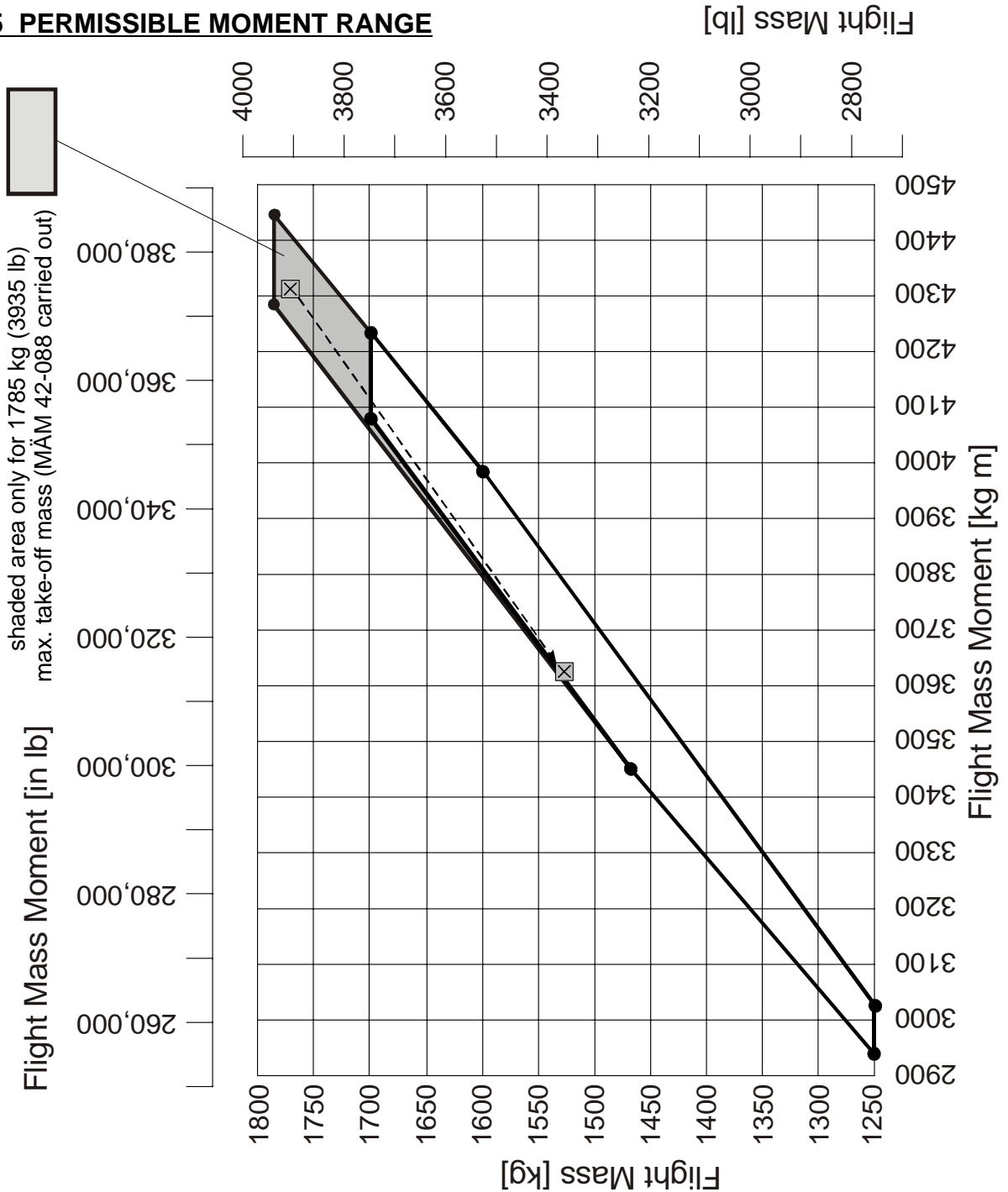

The flight mass moments shown in the diagram are those from the example in Table 6.4.3 (a) 'CALCULATION OF LOADING CONDITION', rows 8 and 11.

6.5 EQUIPMENT LIST AND EQUIPMENT INVENTORY

All equipment that is approved for installation in the DA 42 is shown in the *Equipment List* below.

NOTE

The equipment listed below cannot be installed in any arbitrary combination. The airplane manufacturer must be contacted before removing or installing equipment, with the exception of replacing an unit by an identical unit.

The items of equipment installed in your particular airplane are indicated in the appropriate column. The set of items marked as 'installed' constitutes the *Equipment Inventory*.

Airplane Serial No.:		Registration:		Date:		Mass		Lever Arm	
Description	Type	Part No.	Manufacturer	S/N	inst'd	lbs	kg	in	m
AVIONICS COOLING									
Avionics Cooling Fan	SAFE 328	305 467-00	Sandia Aerospace						
PFD Cooling Fan	SAFE 128	305 468-00	Sandia Aerospace						
MFD Cooling Fan	SAFE 128	305 468-00	Sandia Aerospace						
AUTOPILOT SYSTEM									
	KAP 140								
Flight Computer	KC 140	065-00176-7904	Bendix/King			2.040	0.930	70.080	1.780
Pitch servo	KS 270 C	065-00178-2500	Bendix/King			2.290	1.040	175.400	4.455
Pitch servo mount	KM 275	065-00030-0000	Bendix/King			1.077	0.489	175.400	4.455
Roll servo	KS 271 C	065-00179-0500	Bendix/King			2.290	1.040	124.800	3.170
Roll servo mount	KM 275	065-00030-0000	Bendix/King			1.077	0.489	124.800	3.170
Trim servo	KS 272 C	065-00180-3500	Bendix/King			2.290	1.040	88.190	2.240
Trim servo mount	KM 277	065-00041-0000	Bendix/King			1.097	0.498	88.190	2.240
Configuration module	KCM100	071-00073-5000	Bendix/King						
Sonalert	SC 628		Mallory						
Control slick	DA4-2213-12-90		Diamond Aircraft						
CWS switch	031-00514-0000		Bendix/King						
AP-Disc switch	031-00428-0000		Bendix/King						
Trim switch assy	200-09187-0000		Bendix/King						
ELECTRICAL POWER									
Main Battery	G-243 (CB24-11M)		Gill (Concorde)			28.100	13.060	49.170	1.249
Main Battery	RG24-11M		Concorde			28.000	12.700	49.170	1.249
Main Battery	RG24-15M		Concorde						



Airplane Serial No.:		Registration:		Date:		Mass		Lever Arm	
Description	Type	Part No.	Manufacturer	S/N	inst'd	lbs	kg	in	m
Excitation Battery (2 pcs.)	LC-R121R3P		Panasonic						
Emergency Battery		D60-2560-91-00	Diamond Aircraft						
ECU Backup Battery LH (2 pcs.)	LC-R121R3P		Panasonic						
ECU Backup Battery RH (2 pcs.)	LC-R121R3P		Panasonic						
ECU Backup Battery LH (2 pcs.)	LC-R127R2P		Panasonic						
ECU Backup Battery RH (2 pcs.)	LC-R127R2P		Panasonic						
External Power Connector		DA4-2443-10-00	Diamond Aircraft						
MISSION EQUIPMENT									
DC-DC Converter		AK 551-9M	Ameri King						
EQUIPMENT									
Safety belt, pilot	5-01-0 Series	5-01-1C5710	Schroth			2.110	0.960	92.520	2.350
Safety belt, copilot	5-01-0 Series	5-01-1C0710	Schroth			2.110	0.960	92.520	2.350
Safety belt, LH pax	5-01-0 Series	5-01-1B5710	Schroth			2.250	1.020	126.800	3.220
Safety belt, RH pax	5-01-0 Series	5-01-1B0710	Schroth			2.250	1.020	126.800	3.220
Safety belt, pilot	5-01-0 Series	5-01-2G5710	Schroth			2.110	0.960	92.520	2.350
Safety belt, copilot	5-01-0 Series	5-01-2G0710	Schroth			2.110	0.960	92.520	2.350
Safety belt, LH pax	5-01-0 Series	5-01-2H5710	Schroth			2.250	1.020	126.800	3.220
Safety belt, RH pax	5-01-0 Series	5-01-2H0710	Schroth			2.250	1.020	126.800	3.220
Safety belt, pilot	5-01-0 Series	5-01-2G5701	Schroth			2.110	0.960	92.520	2.350
Safety belt, copilot	5-01-0 Series	5-01-2G0701	Schroth			2.110	0.960	92.520	2.350
Safety belt, LH pax	5-01-0 Series	5-01-2H5701	Schroth			2.250	1.020	126.800	3.220
Safety belt, RH pax	5-01-0 Series	5-01-2H0701	Schroth			2.250	1.020	126.800	3.220



Airplane Serial No.:		Registration:		Date:		Mass		Lever Arm	
Description	Type	Part No.	Manufacturer	S/N	inst'd	lbs	kg	in	m
ELT unit	C406-1	453-5002-	Artex			4.220	2.774	179.700	4.565
ELT unit	ME406	453-6603-	Artex			2.770	1.260	179.700	4.565
ELT remote switch		345-6196-04	Artex						
ELT antenna		110-338	Artex			0.470	0.213	152.800	3.880
Buzzer		130-4004	Artex						
SAFETY EQUIPMENT									
Fire extinguisher		HAL 1	AIR Total						
First aid kit									
FLIGHT CONTROLS									
Flaps actuator assy		43055	Krutz						
Lift detector		C-99701-1	Safe Flight Instr.						
Stall warning buzzer	SC Series	SC 628 ND	Mallory						
Variable elevator stop		D60-2733-12-00	Diamond Aircraft						
HYDRAULIC									
Motor pump unit		X11-0001-00-00.00R0	Hydraulik Mayer						
Hydraulic fluid tank		X11-0002-00-00.00R0	Hydraulik Mayer						
Hydraulic control unit		X11-0003-00-00.00R0	Hydraulik Mayer						
High pressure filter		X11-0004-00-00.00R0	Hydraulik Mayer						
Hydraulic pressure accumulator		X11-0005-00-00.00R0	Hydraulik Mayer						
MLG hydraulic cylinder		X11-0006-00-00.00/1R0	Hydraulik Mayer						
MLG hydraulic cylinder		X11-0006-00-00.00/1R0	Hydraulik Mayer						
NLG hydraulic cylinder		X11-0006-00-00.00/2R0	Hydraulik Mayer						



Airplane Serial No.:		Registration:		Date:		Mass		Lever Arm	
Description	Type	Part No.	Manufacturer	S/N	inst'd	lbs	kg	in	m
Brake master cylinder (2 pcs.)		10-54A	Cleveland						
Parking valve		60-5B	Cleveland						
Brake assembly		30-239A	Cleveland						
INDICATING / REC. SYSTEM									
Primary Flight Display (PFD)	GDU 1040	011-00972-02	Garmin			6.400	2.910	70.080	1.780
Primary Flight Display (PFD)	GDU 1040	011-00972-03	Garmin			6.400	2.910	70.080	1.780
Multi Function Display (MFD)	GDU 1040	011-00972-02	Garmin			6.400	2.910	70.080	1.780
Multi Function Display (MFD)	GDU 1040	011-00972-03	Garmin			6.400	2.910	70.080	1.780
LANDING GEAR									
Main landing gear LH		D60-3217-11-00	Diamond Aircraft						
Main landing gear RH		D60-3217-12-00	Diamond Aircraft						
Nose landing gear		D60-3223-10-00	Diamond Aircraft						
LDG Gear Warning	SC Series	SC 628 NDP	Mallory						
LIGHTS									
Map / Reading light assy crew		W1461.0.010	Rivoret						
Cabin Light		W1461.0.010	Rivoret						
Strobe / Pos. light assy LH	A600-PR-D-28	01-0790006-05	Whelen			1.590	0.719	103.800	2.638
Strobe / Pos. light assy RH	A600-PG-D-28	01-0790006-07	Whelen			1.590	0.719	103.800	2.638
Strobe light power supply LH/RH	A490ATS-CF-14/28	01-0770062-05	Whelen						
Taxi light	Xenon D1S		Aero Vision Int.			0.990	0.449	79.920	2.030
Taxi light power supply	XV1-28		Aero Vision Int.			0.880	0.400	82.290	2.090

Airplane Serial No.:		Registration:		Date:		Mass		Lever Arm	
Description	Type	Part No.	Manufacturer	S/N	inst'd	lbs	kg	in	m
Landing light	Xenon DTS		Aero Vision Int.			0.990	0.449	79.920	2.030
Landing light power supply	XV1-28		Aero Vision Int.			0.880	0.400	82.290	2.090
Glareshield lamp assy		DA4-3311-10-02	Diamond Aircraft						
Glareshield light inverter		APVL328-4-1-L-5QF	Quantaflex						
Placards inverter		APVL328-4-1-L-15QF	Quantaflex						
COMMUNICATION / NAVIGATION									
COMM #1 antenna	DMC63-1/A		DM			0.400	0.180	177.100	4.500
COMM #2 antenna	DMC63-2		DM			0.400	0.180	155.100	3.940
Audio Panel / Marker / ICS	GMA 1347	011-00809-00	Garmin						
Headset, pilot	Echelon 100		Telex						
Headset, pilot	HMEC25-KAP-2	025-230-715	Sennheiser						
Headset, copilot	Echelon 100		Telex						
Headset, copilot	HMEC25-KAP-2	025-230-715	Sennheiser						
Headset, LH pax	Echelon 100		Telex						
Headset, LH pax	HMEC25-KAP-2	025-230-715	Sennheiser						
Headset, RH pax	Echelon 100		Telex						
Headset, RH pax	HMEC25-KAP-2	025-230-715	Sennheiser						
Speaker	FRS8 / 4 Ohms		Visaton						
Handmic	100 TRA	62800-001	Telex						
Pitot/Static probe, heated		DAI-9034-57-00	Diamond Aircraft						
Pitot/Static probe, heated	AN5814-2	PST-305	AeroInstruments						
Alternate static valve		DA4-3111-51-00	Diamond Aircraft						
Backup Altimeter		5934PD-3	United Instruments			0.496	0.225	70.080	1.780
Backup Altimeter	LUN 1128	1128.10B6	Mikrotechna						



Airplane Serial No.:		Registration:			Date:		Mass		Lever Arm	
Description	Type	Part No.	Manufacturer	S/N	inst'd	lbs	kg	in	m	
Backup Altimeter	LUN 1120	1120-23B2X	Mikrotechna							
Backup airspeed indicator	8030	8030-B.864	United Instruments			0.680	0.308	70.080	1.780	
Backup airspeed indicator	LUN 1116	1116.LOB3	Mikrotechna							
Backup artificial horizon	4300	4300-206	Mid Continent Instr.			2.500	1.132	70.080	1.780	
Backup artificial horizon	LUN 1241	1241.G8D0R	Mikrotechna							
Magnetic compass		PG2C-28V	SIRS Navigation							
Turn & Bank indicator	1394T100-(12RZ)		Mid Continent Instr.			1.410	0.640	70.080	1.780	
Turn & Bank indicator	1394T100-(12RA)		Mid Continent Instr.			1.410	0.640	70.080	1.780	
Turn & Bank indicator	1394T100-(12RB)		Mid Continent Instr.			1.410	0.640	70.080	1.780	
OAT probe	GTP 59	011-00978-00	Garmin							
Digital Air Data System	GDC 74A	011-00882-00	Garmin			1.580	0.720	70.080	1.780	
Integrated Avionics #1	GIA 63	011-00781-01	Garmin			5.290	2.400	154.900	3.935	
Integrated Avionics #2	GIA 63	011-00781-01	Garmin			5.290	2.400	154.900	3.935	
Transponder	GTX 33	011-00779-00	Garmin			3.030	1.380	153.100	3.890	
Transponder	GTX 33	011-00779-10	Garmin			3.030	1.380	153.100	3.890	
Altitude / Heading Reference System	GRS 77	011-00868-00	Garmin			2.540	1.150	154.900	3.935	
Altitude / Heading Reference System	GRS 77	011-00868-10	Garmin			2.540	1.150	154.900	3.935	
Magnetometer	GMU 44	011-00870-00	Garmin			0.379	0.172	103.800	2.638	
VOR / LOC / GS antenna	CI 157P		Comant							
dual VOR / dual GS duplexer	CI 1125		Comant							
LH: VOR / LOC / GS antenna	CI120-1		Comant							
RH: VOR / LOC / GS antenna	CI120-1		Comant							
VOR / LOC / GS PWR combiner	CI120-3		Comant							
Transponder antenna	KA 60	071-01591-0001	Bendix/King			0.220	0.100	91.930	2.335	
Transponder antenna	KA 61	071-00221-0010	Bendix/King							

Airplane Serial No.:		Registration:		Date:		Mass		Lever Arm	
Description	Type	Part No.	Manufacturer	S/N	inst'd	lbs	kg	in	m
Marker antenna	CI 102		Comant						
GPS #1 antenna	GA 56	010-10040-01	Garmin			0.400	0.180	104.100	2.645
GPS #2 antenna	GA 56	010-10040-01	Garmin			0.400	0.180	104.100	2.645
DME	KN 63	066-1070-01	Bendix/King			2.480	1.120	141.100	3.580
DME antenna	KA 60	071-01591-0001	Bendix/King			0.220	0.100	91.930	2.335
DME antenna	KA 61	071-00221-0010	Bendix/King						
ADF receiver	RA 3502-(01)	0505.757-912	Becker			2.080	0.940	155.500	3.950
ADF / RMI converter	AC 3504-(01)	0856.010-912	Becker			1.300	0.590	165.400	4.200
ADF antenna	AN 3500	0832.601-912	Becker			3.450	1.560	133.900	3.400
Stormscope	WX-500	805-11500-001	L-3 (Goodrich)			2.290	1.040	140.100	3.560
Stormscope antenna	NY-163	805-10930-001	L-3 (Goodrich)			0.820	0.370	280.700	7.130
TAS Processor	TAS 600	70-2420-x TAS600	Avidyne/Ryan						
TAS Processor	TAS 610	70-2420-x TAS610	Avidyne/Ryan			6.800	3.100	164.300	4.175
TAS Processor	TAS 620	70-2420-x TAS620	Avidyne/Ryan						
TAS Processor	9900BX	70-2420-x	Avidyne/Ryan						
Transponder coupler		70-2040	Avidyne/Ryan			0.500	0.230	197.600	5.020
TAS antenna, top		S72-1750-31L	Sensor Systems			0.660	0.298	164.800	4.188
TAS antenna, bottom		S72-1750-32L	Sensor Systems			0.750	0.340	104.300	2.650
Data link processor	GDL69A	011-00987-00	Garmin			2.490	1.130	159.400	4.050
GDL Antenna	GA 57	011-01032-00	Garmin			0.470	0.210	105.500	2.680
OXYGEN SYSTEM									
Oxygen cylinder (empty)		1270152-2	Aerox			7.400	3.357	32.280	0.820
Single outlet manifold LH		4110-401-2	Aerox			0.230	0.104	69.690	1.770
Single outlet manifold RH		4110-401-2	Aerox			0.230	0.104	69.690	1.770



Airplane Serial No.:		Registration:		Date:		Mass		Lever Arm	
Description	Type	Part No.	Manufacturer	S/N	inst'd	lbs	kg	in	m
Dual outlet manifold		4110-400-2	Aerox			0.420	0.191	109.300	2.775
Oxygen pressure regulator		4110-110	Aerox			0.740	0.336	21.260	0.540
Filling block		4110-405	Aerox			0.540	0.245	28.150	0.715
Pressure gauge		4110-490	Aerox			0.110	0.050	70.080	1.780
ENGINE									
Thielert TAE 125-01 (if installed)									
LH Engine	TAE-125-01	125-01-(017)-()	Thielert						
RH Engine	TAE-125-01	125-01-(017)-()	Thielert						
LH ENGINE CONTROL UNIT	ECU	02-7610-55003R()	Thielert						
	ECU	02-7610-55181R()	Thielert						
	ECU Firmware	TAE-125-m2.7*	Thielert						
	ECU Mapping	R28V270DIA*	Thielert						
RH ENGINE CONTROL UNIT	ECU	02-7610-55003R()	Thielert						
	ECU	02-7610-55181R()	Thielert						
	ECU Firmware	TAE-125-m2.7*	Thielert						
	ECU Mapping	R28V270DIA*	Thielert						
ENGINE STARTING									
Glow Power Control Unit LH/RH		02-7150-55005R1	Thielert						
Starter LH/RH		02-8010-13210R1	Thielert						
ELECTRICAL POWER									
LH Alternator		02-7150-55110R2	Thielert						
LH Alternator		02-7150-55030R1	Thielert						
RH Alternator		02-7150-55110R2	Thielert						

Airplane Serial No.:		Registration:		Date:		Mass		Lever Arm	
Description	Type	Part No.	Manufacturer	S/N	inst'd	lbs	kg	in	m
RH Alternator		02-7150-55030R1	Thielert						
LH Alternator Regulator		02-7150-55112R2	Thielert						
RH Alternator Regulator		02-7150-55112R2	Thielert						
Thielert TAE 125-02-99 (if installed)									
LH Engine	TAE-125-02-99	125-02-99-(0003)-(01)	Thielert						
RH Engine	TAE-125-02-99	125-02-99-(0003)-(01)	Thielert						
LH ENGINE CONTROL UNIT	ECU	05-7610-E000201	Thielert						
	ECU Firmware	TAE 125 m2.7*	Thielert						
	ECU Mapping	O28V271DA42*	Thielert						
	ECU Mapping	O28V272DA42*	Thielert						
RH ENGINE CONTROL UNIT	ECU	05-7610-E000201	Thielert						
	ECU Firmware	TAE 125 m2.7*	Thielert						
	ECU Mapping	O28V271DA42*	Thielert						
	ECU Mapping	O28V272DA42*	Thielert						
ENGINE STARTING									
Glow Plug Control Unit LH/RH		05-7151-E0004 01	Thielert						
Starter LH/RH		05-8010-E0028 01	Thielert						
ELECTRICAL POWER									
LH Alternator		05-7150-E0006 01	Thielert						
RH Alternator		05-7150-E0006 01	Thielert						
LH Alternator Regulator		05-7150-E0007 01	Thielert						
RH Alternator Regulator		05-7150-E0007 01	Thielert						



Airplane Serial No.:		Registration:		Date:		Mass		Lever Arm	
Description	Type	Part No.	Manufacturer	S/N	inst'd	lbs	kg	in	m
ENGINE FIRE WARNING									
LH overheat detector		X 2003-2	Control Products, Inc.	/	/				
RH overheat detector		X 2003-2	Control Products, Inc.	/	/				
ENGINE INDICATING									
Engine / Airframe Unit	GEA 71	011-00831-00	Garmin						
PROPELLER									
Propeller LH	MTV-6-A-C- F/CF187-129		mt-propeller						
Propeller RH	MTV-6-A-C- F/CF187-129		mt-propeller						
Unfeathering accumulator LH		X11-0007-00-00	Hydraulik Mayer	/	/				
Unfeathering accumulator RH		X11-0007-00-00	Hydraulik Mayer	/	/				
Unfeathering accumulator LH		P-893	mt-propeller	/	/				
Unfeathering accumulator RH		P-893	mt-propeller	/	/				
AIRPLANE FLIGHT MANUAL									
	Doc. No. 7.01.05-E	Diamond Aircraft		/	/				
FUEL TANK SYSTEM									
Fuel probe assy., LH inboard		D60-2817-13-00	Diamond Aircraft	/	/				
Fuel probe assy., LH inboard		D60-2817-13-00_1	Diamond Aircraft	/	/				
Fuel probe assy., RH inboard		D60-2817-13-00	Diamond Aircraft	/	/				
Fuel probe assy., RH inboard		D60-2817-13-00_1	Diamond Aircraft	/	/				
Fuel probe assy., LH outboard		D60-2817-14-00	Diamond Aircraft	/	/				
Fuel probe assy., LH outboard		D60-2817-14-00_1	Diamond Aircraft	/	/				



Airplane Serial No.:		Registration:		Date:		Mass		Lever Arm	
Description	Type	Part No.	Manufacturer	S/N	inst'd	lbs	kg	in	m
Fuel probe Assy., RH outboard		D60-2817-14-00	Diamond Aircraft						
Fuel probe Assy., RH outboard		D60-2817-14-00_1	Diamond Aircraft						
Alternate means for fuel qty.		D60-2817-90-00	Diamond Aircraft						
AUX FUEL SYSTEM									
LH auxiliary fuel pump		5100-09	Dukes			1.940	0.878	151.400	3.846
RH auxiliary fuel pump		5100-09	Dukes			1.940	0.878	151.400	3.846
ICE PROTECTION SYSTEM									
Porous panel, outer wing, LH		12102-21	CAV Aerospace						
Porous panel, outer wing, RH		12102-22							
Porous panel, center wing, LH		12102-23							
Porous panel, center wing, RH		12102-24							
Porous panel, horizontal tail, LH		12102-25							
Porous panel, horizontal tail, RH		12102-26							
Porous panel, vertical tail		12102-27							
Inlet strainer		12121-02							
Spray bar		12124-10							
Metering pump 1		9513A-386				4.180	1.896	40.160	1.020
Metering pump 2		9513A-386				4.180	1.896	40.160	1.020
De-icing fluid tank		D60-3013-24-50				8.140	3.692	38.390	0.975
Filter 1		F908				0.680	0.308	40.160	1.020
Filter 2		F908				0.680	0.308	40.160	1.020
Solenoid valve		FV158H-28V				0.870	0.395	40.160	1.020
Solenoid valve		FV158H-28V				0.870	0.395	40.160	1.020



Airplane Serial No.:	Registration:		Date:		Mass		Lever Arm		
	Type	Part No.	Manufacturer	S/N	inst'd	lbs	kg	in	m
High pressure switch		P041ED850	CAV Aerospace						
Proportioning unit, nacelle, LH		PU300DW142	CAV Aerospace						
Proportioning unit, nacelle, RH		PU300DW142	CAV Aerospace						
Tail bracket assembly		12132-03	CAV Aerospace			1.070	0.485	278.700	7.080
Windshield pump 1		WP209A	CAV Aerospace			0.650	0.295	40.160	1.020
Windshield pump 2		WP209A	CAV Aerospace			0.650	0.295	40.160	1.020
De-ice control box		DAI-9030-00-01	Diamond Aircraft						

*) Refer to Service Bulletin SB 42-007 latest effective issue for approved ECU firmware and mapping

Place: _____

Date: _____

Signature: _____



Intentionally left blank.

CHAPTER 7

DESCRIPTION OF THE AIRPLANE AND ITS SYSTEMS

	Page
7.1 INTRODUCTION	3
7.2 AIRFRAME	3
7.3 FLIGHT CONTROLS	4
7.4 INSTRUMENT PANEL	11
7.5 LANDING GEAR	14
7.6 SEATS AND SAFETY HARNESSSES	20
7.7 BAGGAGE COMPARTMENT	22
7.8 CANOPY, REAR DOOR, AND CABIN INTERIOR	22
7.9 POWER PLANT	24
7.9.1 ENGINES, GENERAL	24
7.9.2 PROPELLER	25
7.9.3 OPERATING CONTROLS	28
7.9.4 ENGINE INSTRUMENTS	32
7.9.5 FUEL SYSTEM	34
7.9.6 COOLING SYSTEM	45
7.9.7 OIL SYSTEMS	46
7.9.8 TURBO-CHARGER SYSTEM	47
7.9.9 FIRE DETECTION SYSTEM	48
7.10 ELECTRICAL SYSTEM	49
7.10.1 GENERAL	50
7.10.2 ENGINE CONTROL UNIT / ECU	56
7.10.3 WARNING, CAUTION AND ADVISORY MESSAGES	58
7.11 PITOT-STATIC SYSTEM	64

7.12 STALL WARNING SYSTEM 64

7.13 GARMIN G1000 INTEGRATED AVIONICS SYSTEM 65

 7.13.1 GENERAL 65

 7.13.2 PRIMARY FLIGHT DISPLAY (PFD) 66

 7.13.3 MULTI-FUNCTION DISPLAY (MFD) 68

 7.13.4 AUDIO PANEL 69

 7.13.5 ATTITUDE AND HEADING REFERENCE SYSTEM (AHRS)
 69

 7.13.6 AIR DATA COMPUTER (ADC) 69

7.1 INTRODUCTION

Chapter 7 contains a description of the airplane and its systems, together with operating instructions.

For details about optional equipment see Chapter 9.

7.2 AIRFRAME

Fuselage

The CFRP fuselage is of semi monocoque molded construction. The center wing is attached to the fuselage with bolts. The two main spars and both nacelles are part of the center wing. The two main spars are CFRP items. The engine compartment in each nacelle is separated from the other structure with a firewall. The fire protection on the firewall is of a special fire-resistant matting, which is covered on the engine side by stainless steel cladding.

Wings

The wings have a front and rear spar; each wing has a top shell and a bottom shell; The whole wing is 'fail-safe' design. The wings, as well as the ailerons and flaps, are made of GFRP/CFRP, and are principally of sandwich construction. An aluminum fuel tank is installed in each of the wings.

Empennage

The airplane has a 'T' tail of GFRP/CFRP semi monocoque construction. Both the stabilizers have twin spars. Rudder and elevator are of sandwich construction.

7.3 FLIGHT CONTROLS

The ailerons, elevator and wing flaps are operated through control rods, while the rudder is controlled by cables. The flaps are electrically operated. Elevator forces can be balanced by a trim tab on the elevator, which is operated by a Bowden cable. Rudder forces can be balanced by a trim tab on the rudder, which is also operated by a Bowden cable.

Ailerons

Construction: GFRP/CFRP composite sandwich.

Hinges: There are 4 hinges, which are hinge pins mounted in an aluminum bracket. They are secured in position by a roll pin. The absence of this roll pin can lead to the loss of the hinge pin and a consequent loss of flight safety.

Operation: A rod end bearing is screwed into a steel push rod and locked by means of a jam nut which has locking varnish applied to it. Damage to this varnish can indicate a twisting and thus a change to the adjustment. The connection between the rod end bearing and the control horn is a bolt, the nut of which is likewise sealed with locking varnish.

The aluminum control horn is attached to the aileron with 3 screws.

Flaps

The flaps are a two piece construction. The inner part of the flap is mounted to the center wing and the outer part to the wing. Both parts are connected to each other with a form fit connection.

Construction: GFRP/CFRP composite sandwich.

Hinges: There are 6 hinges at the outer part and 4 hinges at the inner part of the flap. These hinges are hinge pins mounted in an aluminum bracket. They are secured in position by a roll pin. The absence of this roll pin can lead to the loss of the hinge pin and a consequent loss of flight safety.

Operation: Each part is connected with a flap control horn to the push rods of the flap control system. A rod end bearing is screwed into a steel push rod and locked by means of a jam nut which has locking varnish applied to it. Damage to this varnish can indicate a twisting and thus a change to the adjustment. The connection between the rod end bearing and the control horn is a bolt, the nut of which is likewise sealed with locking varnish.

Each flap control horn is attached to the flap part with 3 screws.

The flaps are driven by an electric motor and have 3 settings:

- Cruise (UP), totally retracted
- Approach (APP), and
- Landing (LDG).

The flaps are operated by means of a 3-position flap selector switch on the instrument panel. The positions of the switch correspond to the positions of the flaps, the Cruise position of the switch being at the top. If the switch is moved to another position, the flaps continue to travel automatically until they have reached the position selected on the switch. The UP and LDG positions are additionally protected by a limit switch to guard against over-running the end positions.

The electrical flap drive has an automatic circuit breaker which can also be operated manually.

Flap position indicator:

The current flap position is indicated by means of three lights beside the flap selector switch.

When the upper light (green) is illuminated, the flaps are in the Cruise position (UP);

when the center light (white) is illuminated, the flaps are in Approach position (APP);

when the lower light (white) is illuminated, the flaps are in Landing position (LDG).

When two lights are illuminated simultaneously, the flaps are between the two indicated positions. This is the case only when the flaps are in transition.

Elevator

Construction: GFRP sandwich.

Hinges: 5 hinges.

Operation: Steel pushrods;

Two of the bellcrank bearings are accessible for visual inspection next to the lower hinge of the rudder. The elevator horn and its bearing, as well as the connection to the pushrod, can be visually inspected at the upper end of the rudder.

Variable elevator stop:

The DA 42 is equipped with an electrically operated actuator that limits the elevator-up travel to 13° as soon as the power setting of both engines exceeds approximately 20 % (approach power setting) and the flap selector switch is set to LDG. This is 2.5° less than the 15.5° full deflection.

The linear actuator acts as a movable stop and is controlled by three switches, one for each power lever and one for the flap selector. When the power of one engine is reduced below approximately 20 %, or the flap selector is not in the LDG position, full elevator deflection is regained.

An amber annunciation (CAUTION) on the G1000 display is provided to inform the pilot in case a malfunction occurs. The annunciation illuminates when the variable stop should be in place and is actually not activated (power on condition) or should be retracted and actually limits the elevator travel (power off condition).

Rudder

Construction: GFRP sandwich.

Hinges: Upper hinge: One bolt.

Lower hinge: Bearing bracket including rudder stops, held by 4 screws to the rear web of the vertical stabilizer. The mating part on the rudder is a bracket which is attached to the rudder by 2 bolts. The bolts and nuts are accessible to visual inspection.

Operation: Steel cables, the eyes of which are connected to the bolts on the bracket.

Elevator Trim

The trim control is a black wheel in the center console to the rear of the power lever. To guard against overrotating, the trim wheel incorporates a friction device. A mark on the wheel shows the take-off (T/O) position.

Turn wheel to the front = nose down
Turn wheel to the rear = nose up

Rudder Trim

The trim control is a black wheel in the center console below the instrument panel. A mark on the wheel shows the center position and the direction of movement.

Turn wheel to the right = right turn
Turn wheel to the left = left turn

Pedal Adjustment

NOTE

The pedals may only be adjusted on the ground!

The pedals are unlocked by pulling the black handle which is located behind the rear attachment.

Forward adjustment:

Whilst keeping the handle pulled, push the pedals forward with your feet. Release the handle and allow the pedals to lock into place.

Rearward adjustment:

Using the unlocking handle, pull the pedals back to the desired position. Release the handle and push the pedals forward with your feet until they lock into place.

█ Electrical Pedal Adjustment (optional equipment, OÄM 42-070)

█ **NOTE**

█ The pedals may only be adjusted on the ground!

█ The pedals are adjusted using a rocker switch, located on the rear wall of the leg room.

█ The related circuit breaker is located below the switch.

█ *Forward adjustment:*

█ To move the pedals forward, depress lower side of switch. When pedals are in correct position, release switch.

█ *Rearward adjustment:*

█ To move the pedals in the rearward direction, depress upper side of switch. When pedals are in correct position, release switch.

█ *Locking:*

█ Upon release the switch moves automatically to the 'power off' position, so locking the pedals in the present position.

7.4 INSTRUMENT PANEL

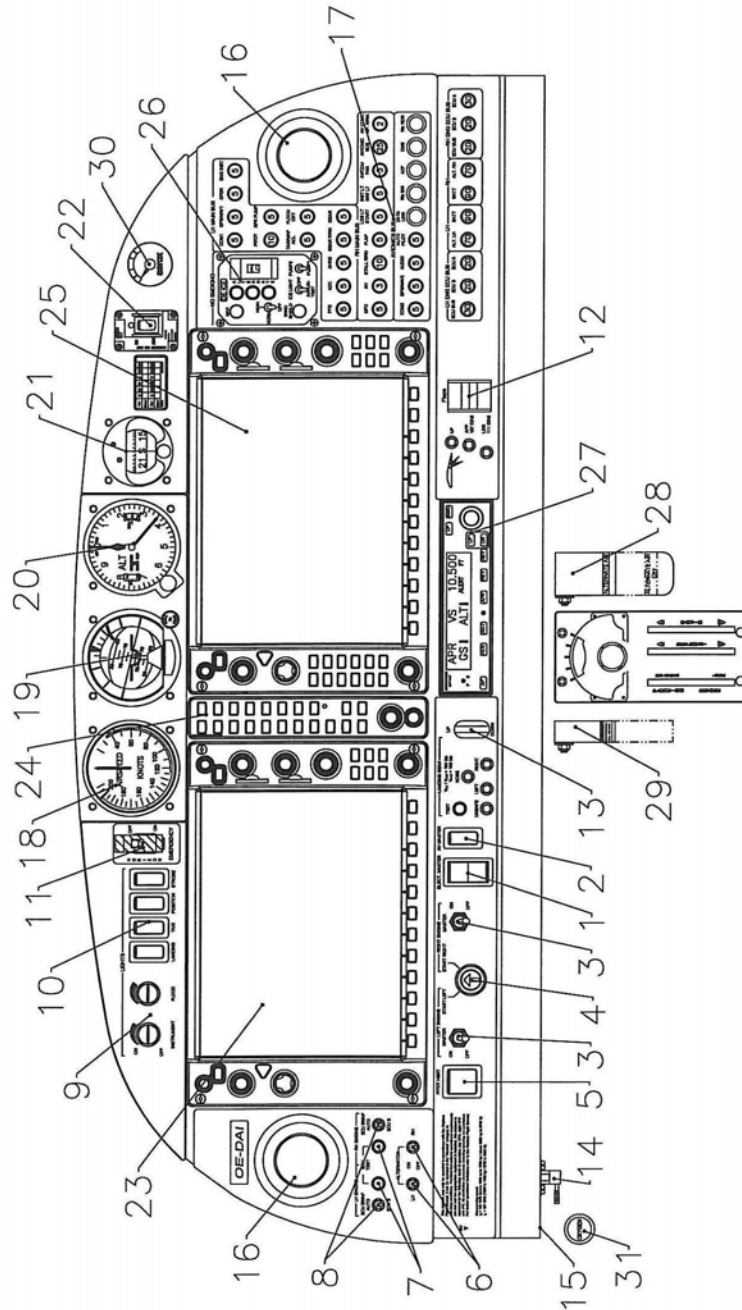

Major instruments and controls			
1	Electric Master switch	17	Circuit breakers*
2	Avionic Master switch	18	Backup airspeed indicator
3	Engine Master switches	19	Backup artificial horizon
4	Start switch	20	Backup altimeter
5	Pitot-/Stall Warning Heat switch	21	Emergency compass
6	Alternator switches	22	ELT control unit
7	ECU Test buttons	23	Primary Flight Display (PFD)
8	ECU Swap switches	24	Audio amplifier / Intercom / Marker beacon receiver
9	Rotary buttons for instrument lighting and flood light	25	Multi Function Display (MFD)
10	Light switches	26	De-Ice control panel
11	Emergency switch	27	Autopilot control unit
12	Flap selector switch	28	Alt air lever
13	Landing gear switch	29	Landing gear emergency extension lever
14	Alternate static valve	30	Oxygen pressure indicator
15	Microphone socket	31	Oxygen control knob
16	Ventilation nozzles		

*) Designations and abbreviations used to identify the circuit breakers are explained in Section 1.5 DEFINITIONS AND ABBREVIATIONS.

NOTE

The figure on the previous page shows the typical DA 42 installation position for the equipment. The actual installation may vary due to the approved equipment version.

Cockpit ventilation

Ventilation in the front is provided by spherical ventilation nozzles (16) in the instrument panel. Furthermore there are spherical nozzles in the roll bar on the left and right side next to the front seats as well as on the central console above the passengers' heads. The spherical nozzles are opened and closed by twisting.

7.5 LANDING GEAR

The landing gear is a fully retractable, hydraulically operated, tricycle landing gear. Struts for the landing gear are air oil assemblies.

The hydraulic pressure for the landing gear operation is provided by an electrically powered hydraulic pump, which is activated by a pressure switch, when the required pressure is too low. Electrically actuated hydraulic valves, which are operated with the gear selector switch, provide the required hydraulic pressure for the movement of the landing gear. The gear selector switch is located on the instrument panel. The switch must be pulled out before it is moved to “UP” or “DOWN” position. Gear extension normally takes 6-10 seconds.

When the landing gear is retracted, the main wheels retract inboard into the center wing and the nose wheel retracts forward into the nose section. Hydraulic pressure on the actuators keeps the landing gear in the retracted position. A pressurized gas container acts as an accumulator which keeps the system pressure constant by replacing the volume lost due to the normal actuator leakages. This prevents a permanent starting of the hydraulic pump in flight.

Springs assist the hydraulic system in gear extension and locking the gear in the down position. After the gears are down and the downlock hooks engage, springs maintain force on each hook to keep it locked until it is released by hydraulic pressure.

The three green lights directly above the landing gear operating switch illuminate to indicate that each gear is in the correct position and locked. If the gear is in neither the full up nor the full down position, a red warning light on the instrument panel illuminates.

- Should one power lever be placed in a position below 25% while the landing gear is retracted, a warning horn sounds to alert the pilot that the gear is retracted. If installed a CHECK GEAR caution is indicated on the PFD additionally. The same warning appears if the flaps move into position LDG (fully extended) while the gear is retracted.

To test the gear warning system (refer to 4A.6.1 - PRE-FLIGHT INSPECTION) push the test button close by the gear selector switch. The aural gear alert should appear.

CAUTION

If the aural alert does not appear, an unscheduled maintenance is necessary.

To prevent inadvertent gear retraction on ground, an electric squat switch prevents the hydraulic valve from switching if the master switch is on and the gear extension switch is placed in the "UP" position.

After take-off, the gear should be retracted before an airspeed of 156 KIAS is exceeded. The landing gear may be extended at any speed up to 194 KIAS.

The landing gear is designed to be manually operated in the event of failure. Since the gear is held in the retracted position by hydraulic pressure, gravity will allow the gear to extend if the system fails for any reason. To extend and lock the gears in the event of failure, it is only necessary to relieve the hydraulic pressure by means of the emergency gear extension lever, which is located under the instrument panel to the left of the center console. Pulling this lever releases the hydraulic pressure and allows the gear to fall free. Before pulling the emergency gear extension lever, place the gear selector switch in the "DOWN" position.

NOTE

If the emergency gear extension has been pulled due to an emergency, the system has to be checked before pushing the lever in again.

The nose gear is steerable by the use of full rudder pedal travel. A gear damping element, incorporated in the nose gear steering system, prevents shimmy tendencies. When the gear is retracted, the nose wheel centers as it enters the wheel well, and the steering linkage disengages to reduce pedal loads in flight.

Hydraulic gear extension system schematic

The main landing gear of the DA 42 is extended with three hydraulic cylinders. The following schematic figures show the system conditions for each operating mode.

In figure 1 the extension of the landing gear is shown. To reduce the amount of pumped hydraulic fluid during this operation, the return flow is partly led into the feeding flow of the system.

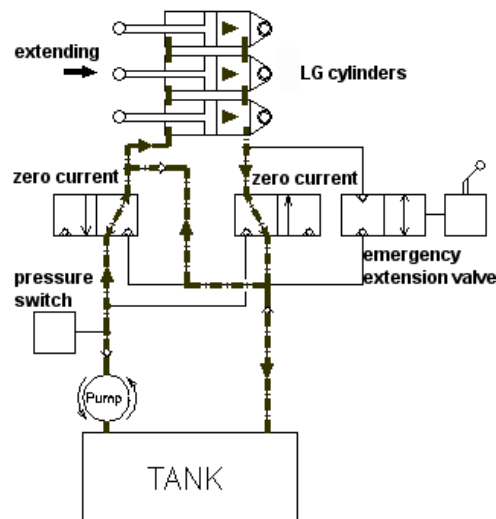

The figure below shows the system status when the landing gear is extended. All hydraulic cylinders are under high pressure.

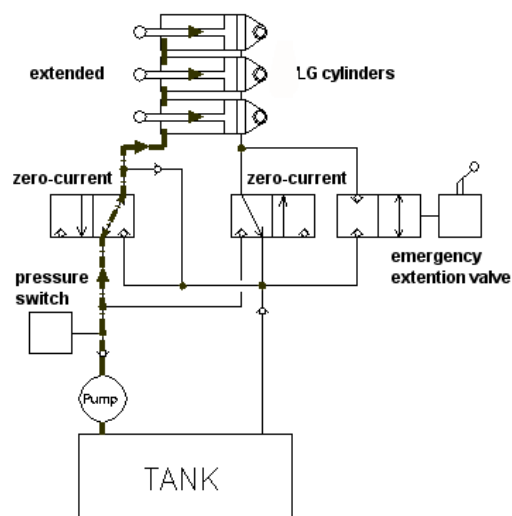

The operating mode for the retraction of the landing gear is shown in the next figure. While energizing the right hydraulic valve, the fluid flow in the hydraulic system is started due to different piston areas of the landing gear cylinders although the pressure on both sides of the system is equal.

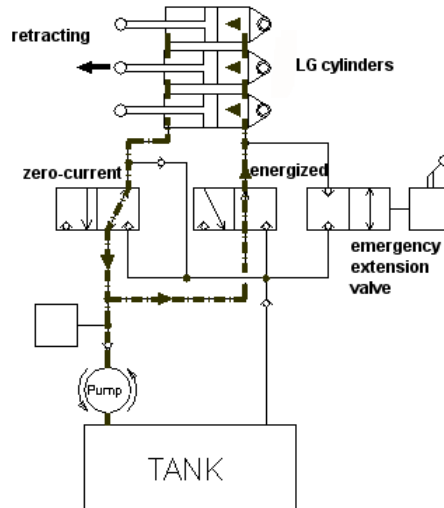

While the landing gear is retracted both valves are energized and excessive hydraulic fluid on one side is drained into the tank. This configuration of the system is shown in the following figure.

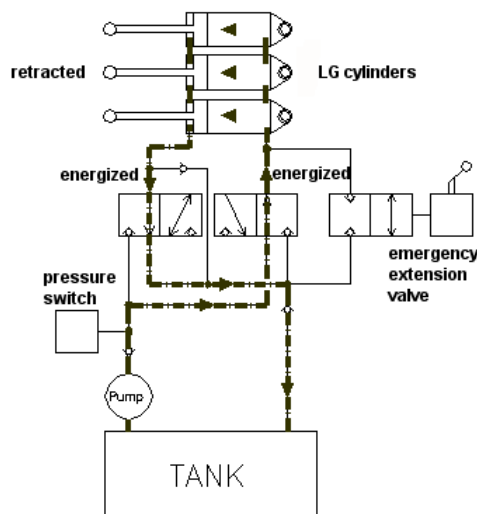

For an emergency extension of the landing gear, the hydraulic fluid can pass through an emergency extension valve so that the gear is extended by gravity. The condition of the system is shown in the figure below.

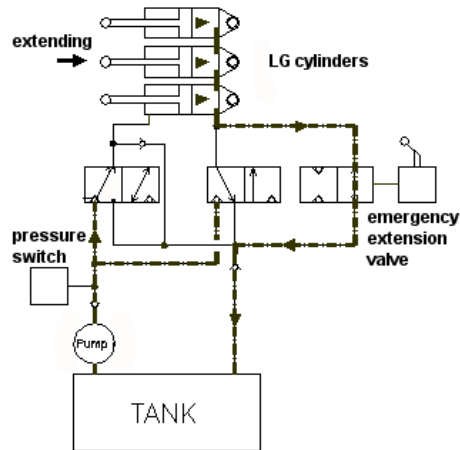

Wheel brakes

Hydraulically operated disk brakes act on the wheels of the main landing gear. The wheel brakes are individually operated by means of toe pedals.

Parking brake

The lever is located on the small center console under the instrument panel and is in the upper position when the brakes are released. To operate the parking brake, pull the lever downwards until it catches. Brake pressure is built up by multiple operation of the toe brake pedals, and is maintained until the parking brake is released. To release, the lever is pushed upwards.

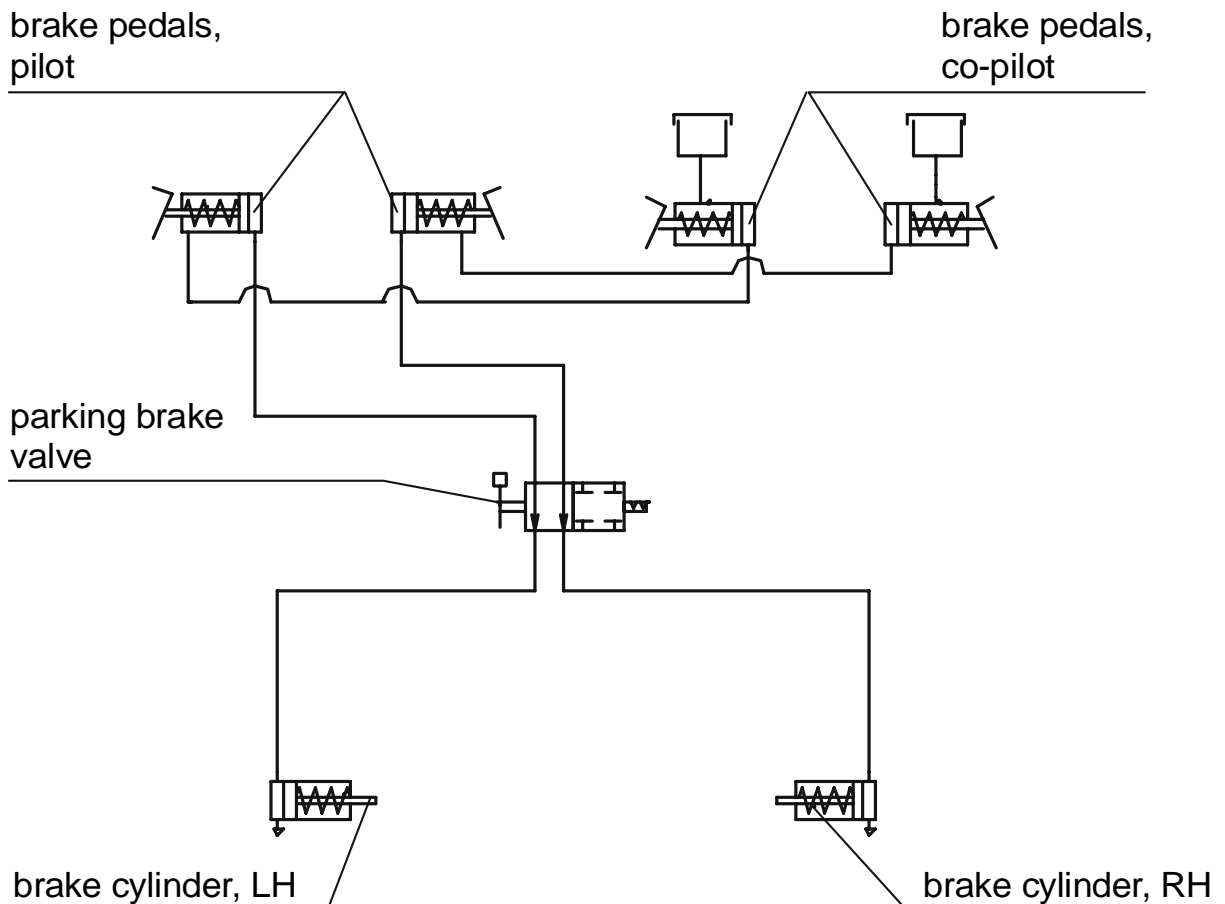

7.6 SEATS AND SAFETY HARNESSSES

To increase passive safety, the seats are constructed using a carbon fiber/Kevlar hybrid material and GFRP. The seats are removable to allow maintenance and inspection of the underlying controls. Covers on the control sticks prevent loose objects from falling into the area of the controls.

The seats have removable furnishings and are equipped with energy-absorbing foam elements.

The seats are fitted with three-part safety harnesses. The harnesses are fastened by inserting the end of the belts in the belt lock, and are opened by pressing the red release on the belt lock.

The backs of the rear seats can be laid forward after pulling upwards on the locking bolt knob.

■ If front seats with adjustable backrests are installed (OAM 42-067), the angle of the
■ backrests can be adjusted for best comfort. The backrest lever is situated on the outboard
■ side of the backrest. However, during take-off, landing and emergency landing the
■ backrests must be fixed in the upright position designated by a placard on the roll-over
■ bar.

CAUTION

■ Before the backrest lever is lifted in order to unlock the
■ backrest, lean back towards the backrest to counteract the
■ spring load; otherwise the backrest may snap forward.

■ For adjustment lift the backrest lever and bend forward or backward to the desired backrest
■ angle. Then lift the backrest lever fully, release and press down to set the friction lock.

In case of a defective adjustment mechanism the outboard friction adjustment screw can be tightened with a 10 mm hexagon nut in clockwise direction in order to fix the backrest in the upright position.

If possible, set the backrest lever to the "locked" position. The mechanism must be repaired at the next scheduled inspection.

The lumbar support can be adjusted by operating the lumbar support lever mounted on the outboard side of the seat pan.

If seats with adjustable backrests are installed (OAM 42-067):

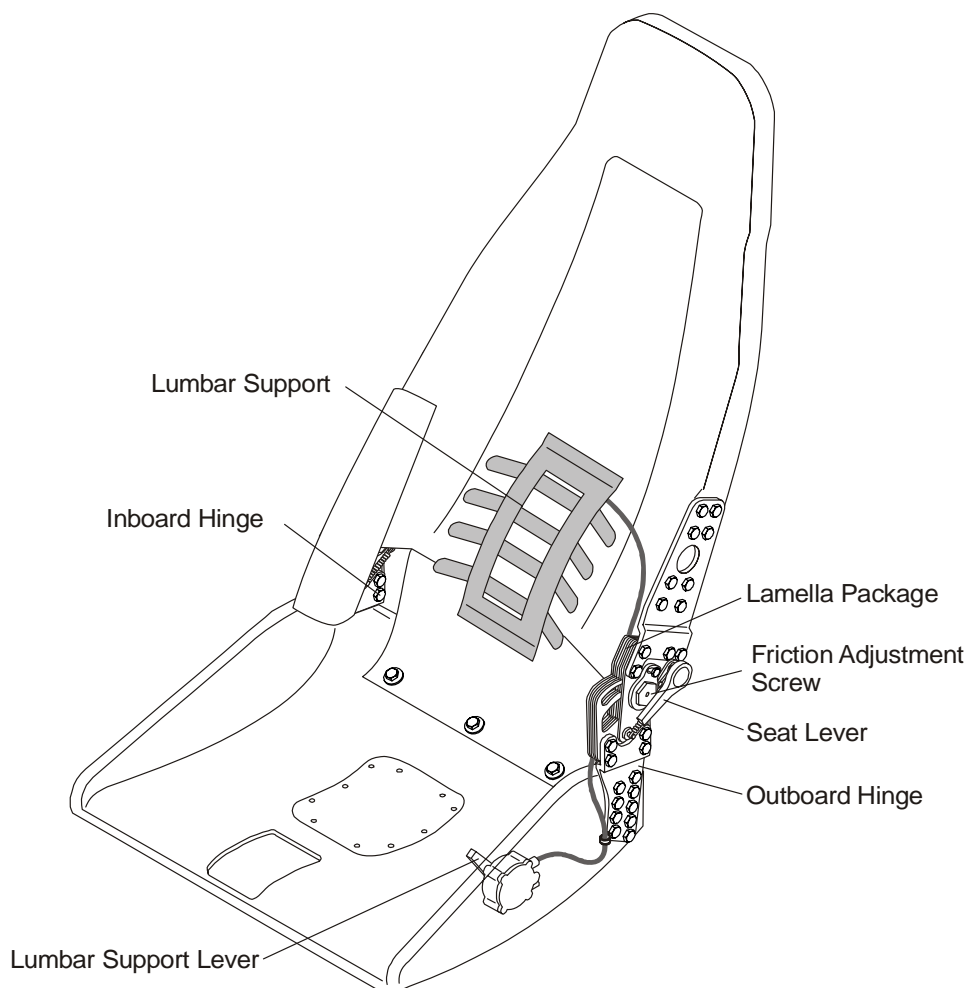

7.7 BAGGAGE COMPARTMENT

There are two baggage compartments. One is located in the nose section and it is accessible through two compartment doors.

The other baggage compartment is behind the seat backs of the rear seats. Baggage may be loaded there provided it is restrained by means of a baggage net.

7.8 CANOPY, REAR DOOR, AND CABIN INTERIOR

Front canopy

The front canopy is closed by pulling down on the canopy frame, following which it is locked by means of a handle on the left hand side of the frame. On locking, steel bolts lock into mating holes in polyethylene blocks.

“Cooling Gap” position: A second setting allows the bolts to lock in, leaving a gap under the forward canopy.

The canopy can be blocked by a locking device on the left side near the canopy opening lever by turning the key clockwise. The closed and blocked canopy can be opened from inside by pulling the lever inside the opening handle.

WARNING

The airplane may be operated with the front canopy in the “cooling gap” position on the ground only. Before take-off the front canopy must be completely closed and locked.

Do not block the front canopy with the locking key before flight in order to assure emergency evacuation from outside.

A window on the left and right hand side of the canopy can be opened for additional ventilation or as an emergency window.

Rear door

The rear door is closed in the same way, by pulling down on the frame and locking it with the handle. A gas pressure damper prevents the door from dropping; in strong winds the assembly must be securely held. The rear door is protected against unintentional opening by an additional lever.

The door can be blocked by a locking device on the left side near the door opening lever by turning the key clockwise. The closed and blocked door can be opened from inside by pulling the lever inside the opening handle.

WARNING

Do not block the door with the locking key before flight in order to assure emergency access from outside.

Heating and ventilation

Heating and ventilation are operated using two levers located on the small center console under the instrument panel.

Right lever:	up	= HEATING ON (Seats, Floor)
	down	= HEATING OFF
Center lever :	up	= DEFROST ON (Airflow to canopy)
	down	= DEFROST OFF

The heat of the RH engine is used for the front seats and floor, the heat of the LH engine is used to defrost the canopy.

The Air inlet for the Ventilation System is placed on the underside of the RH wing, inboard of the engine nacelle. The air is distributed within the cabin via 6 nozzles (2 on the instrument panel LH/RH side, 2 on the overhead panel and 2 on the LH/RH side of the passenger compartment). The jet direction of each cone can be changed easily and the jet intensity can be regulated by rotation of the nozzle.

7.9 POWER PLANT

7.9.1 ENGINES, GENERAL

There are two Thielert Aircraft Engines TAE125 installed, which have the following principal specifications:

- Liquid-cooled four-cylinder four-stroke Diesel-cycle engine with wet sump lubrication
- Inline construction
- Common rail direct injection
- Propeller speed reducing gear 1:1.69
- Digital Engine Control with Integrated Propeller Governor (separate oil system)
- Turbo charger with Intercooler

Displacement:

TAE 125-01 engine:	1689 cm ³ (103 in ³)
TAE 125-02-99 engine (MÄM 42-198 carried out):	1991 cm ³ (121.5 in ³)

Max. power: 99 kW (135 DIN-HP) at 2300 RPM at sea level and ISA

Max. continuous power: 99 kW (135 DIN-HP) at 2300 RPM at sea level and ISA

The indications for monitoring important engine parameters during operation are integrated within the Garmin G1000 display. Each engine can only be operated with the ENGINE MASTER switch ON. Each engine has an own ECU (Engine Control Unit) which receives its electrical power from the generator when at least one engine is running. When both engines are at standstill, the ECU receives its electrical power from the battery.

7.9.2 PROPELLER

Two mt-Propeller MTV-6-A-C-F/CF187-129 hydraulically regulated 3-bladed constant speed feathering propellers are installed. Each propeller has wood composite blades with fiber-reinforced plastic coating and stainless steel edge cladding; in the region of the propeller hub the leading edge is coated with adhesive PU foil. These blades combine the lowest weight whilst minimizing vibration.

Propeller control

The propeller pitch control system is integrated into the engine. The pitch is controlled automatically by the ECU. To change the blade pitch angle gearbox oil is pumped into the propeller hub. The oil pressure is regulated by an electrically operated valve, the governor valve, which is controlled by the ECU. Increasing the oil pressure leads to a decrease of pitch and a higher RPM. Decreasing the pressure leads to higher pitch and a lower RPM.

Depending on the power setting the propeller pitch is adjusted such that the required RPM will be obtained as shown in the following diagram.

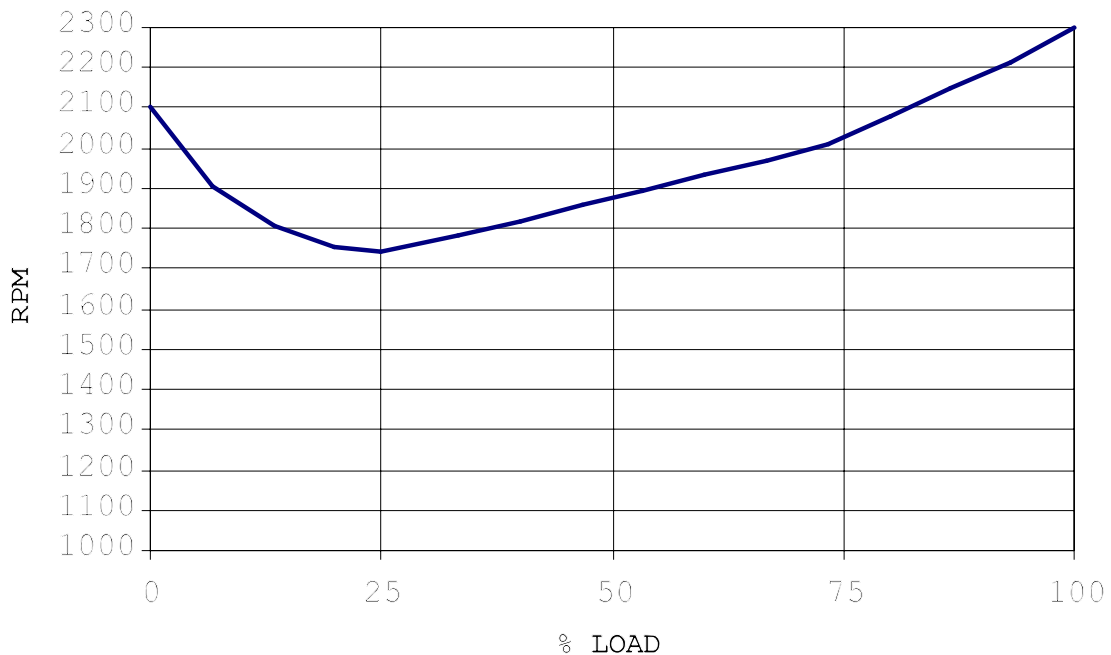

Pressure accumulator:

The pressure accumulator is a nitrogen oil type. It is connected to the gearbox oil circuit via an electric valve at the accumulator, which is operated with the engine master switch.

When the engine master switch is set to ON the valve is opened. When the engine is running, the accumulator is filled with oil at a pressure of approximately 20 bar (290 psi). During engine operation the accumulator makes sure that enough oil pressure is available even if the oil feed by the gearbox oil pump is decreasing due to negative acceleration. The hydraulic pressure keeps the propeller pitch angle below the start lock position, or moves the propeller blades beyond the start lock position.

Feathering:

To feather the propeller the engine must be shut down with the appropriate engine master switch. This will open the electric governor valve. All oil will flow back from the propeller hub, allowing the blades to move into the feathered pitch position. At the same time the electric valve at the pressure accumulator closes, and the oil pressure is restored in the accumulator.

Feathering is only possible at propeller speeds above 1300 RPM.

CAUTION

If the engine is shut down below an RPM of 1300 the propeller pitch remains below the start lock position. In this case the speed must be increased to increase the propeller RPM.

Unfeathering:

To unfeather the propeller, the associated engine master switch must be set to ON. This will open the electric valve at the pressure accumulator. The pressure stored in the accumulator will move the propeller blades into a low pitch position. As soon as the propeller starts turning and the gearbox oil operates, the accumulator will be refilled.

*Ground operation:***CAUTION**

Operation on the ground at high RPM should be avoided as far as possible, as the blades could suffer stone damage. For this reason a suitable site for engine runs should be selected, where there are no loose stones or similar items.

WARNING

Never move the propeller by hand.

7.9.3 OPERATING CONTROLS

Power lever

Engine performance is controlled by a power lever for each engine. Both power levers are situated on the large center console. 'Front' and 'rear' are defined in relation to the direction of flight.

Each power lever is used to set the desired engine power LOAD (%)

Lever forward (MAX) = Full power

Lever to rear (IDLE) = Idle

A separate ECU for each engine controls manifold pressure, injected fuel quantity and propeller speed according to the desired engine power preselected with the power lever. If the power lever is in a low power position - as for a landing approach - while the landing gear is retracted, an aural warning alerts the pilot to the retracted landing gear. If installed a CHECK GEAR caution is indicated on the PFD additionally.

A propeller governor, which is controlled by the ECU, is flanged onto the front of each engine. The propeller governor oil circuit is supplied with oil by the gearbox oil pump (also see Section 7.9.2 - PROPELLER). A loss of oil pressure leads to a feathering of the propeller blades, thus allowing continuation of the flight according to 3.9.3 - DEFECTIVE PROPELLER RPM REGULATING SYSTEM.

CAUTION

Following governor failure the RPM should be adjusted using the power lever. Every effort should be made not to exceed 2300 RPM.

CAUTION

The power lever should be moved slowly, in order to avoid over-speeding and excessively rapid RPM changes. The light wooden propeller blades produce more rapid RPM changes than metal blades.

WARNING

It is possible that the propeller blades remain in the position of highest pitch in case of a malfunction of the engine control unit. In this case the reduced engine performance should be taken into consideration.

ELECT. MASTER

The electric master switch has two positions:

OFF disconnecting battery power

ON connecting battery power to the power distribution system

ENGINE MASTER

Each engine can only be cranked with its ENGINE MASTER switched to ON. When activated, the ENGINE MASTER provides the power supply for the preheat system, the unfeathering accumulator valve and the engine itself. To shut down the engine the appropriate ENGINE MASTER is switched to OFF.

START

Turning START key switch to the left starts the LH engine. Turning it to the right side starts the RH engine.

ECU SWAP

There are two ECU SWAP switches, one for each engine. For normal operation both switches are set to AUTOMATIC. Each engine is controlled by its ECU A. In case of a failure of the active engine control unit (ECU) there should be an automatic switch-over to the appropriate ECU B. If the automatic switch over fails, switch over can be done manually by switching to ECU B. This procedure should only be applied in an emergency.

ECU TEST

There are two ECU TEST buttons, one for each engine. Depending on the position of the power lever and the engine speed, the ECU TEST button has two different functions.

Power lever at IDLE and RPM below approximately 900:

By pushing and holding the button until the end of the procedure, the self-test of each engine control unit is started. The procedure is possible on the ground as well as during flight, but only if the power lever is in the IDLE position. Otherwise the test will not start. During the procedure the ECU performs a switch from ECU A to ECU B with the propeller cycling. The propeller RPM is monitored automatically by the ECU. When switching from one ECU to the other, a slight shake of the engine may occur. Finally the ECU switches back from ECU B to ECU A. After that both caution lights must extinguish and the engine must run without a change.

Power lever above IDLE, or RPM above approximately 900:

If an ECU A or ECU B caution message is displayed, the ECU TEST button can be pressed for more than 2 seconds to reset the message. The reset is possible only once, and only in case of system faults of minor criticality.

Alternate Air

In the event of power loss because of icing or blocking of the air filter, there is the possibility of drawing air from the engine compartment. The ALTERNATE AIR operating lever which serves both engines simultaneously is located under the instrument panel to the right of the center console. To open the alternate air source the lever is pulled to the rear. Normally, the alternate air source is closed with the lever in the forward position.

Placard on the lever, forward position:

ALTERNATE AIR

Placard on the lever, visible when lever is in the rearward position:

**ALTERNATE AIR
ON**

7.9.4 ENGINE INSTRUMENTS

The engine instruments are displayed on the Garmin G1000 MFD. Also refer to Section 7.13.3 - MULTI FUNCTION DISPLAY (MFD). Indications for the LH engine are on the left side, indications for the RH engine are on the right side.

Default page
Engine

Display when pushing
the SYSTEM button

Display when pushing
the FUEL button

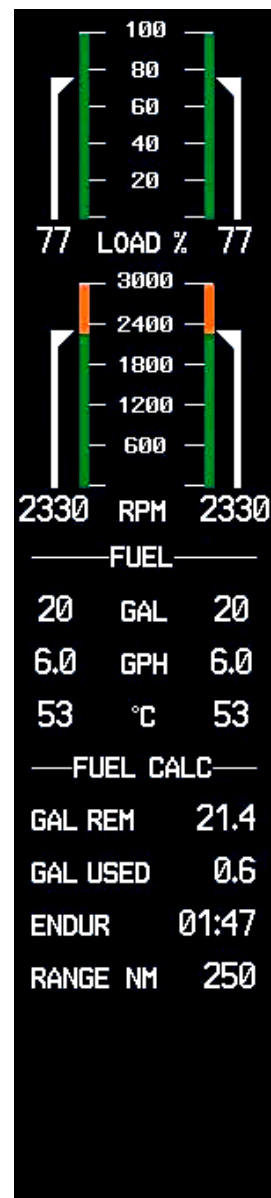
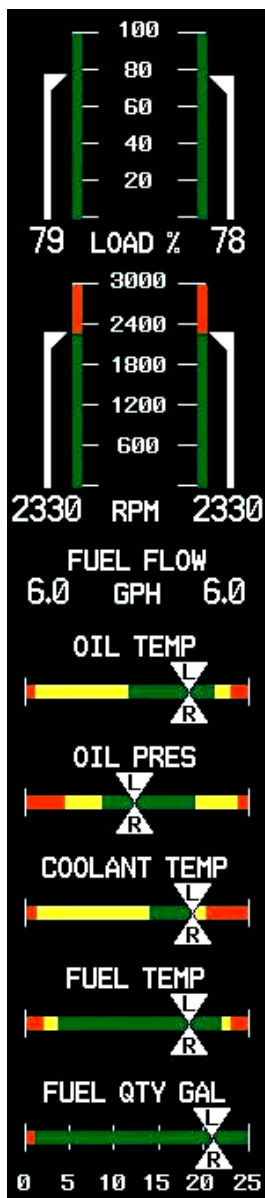

NOTE

The figure on previous page is a general demonstration of a typical G1000 MFD to show the different display modes. The pictured engine instrument markings may not stringently agree with the current engine limitations of the DA 42.

NOTE

The fuel calculations on the FUEL CALC portion do not use the airplane's fuel quantity indicators. The values shown are numbers which are calculated from the last fuel quantity update done by the pilot and actual fuel flow data. Therefore, the endurance and range data is for information only, and must not be used for flight planning.

Designation	Indication	Unit
LOAD %	Available power	%
RPM	Propeller RPM	1/min
FUEL FLOW	Fuel flow	US gal/hr
OIL TEMP	Engine oil temperature	°C
OIL PRES	Oil pressure	bar
COOLANT TEMP	Coolant temperature	°C
FUEL TEMP.	Fuel temperature	°C
FUEL QTY GAL	Fuel quantity	US gal
VOLTS	Volts	V
AMPS	Ampères	A
GEARBOX	Gearbox temperature	°C

7.9.5 FUEL SYSTEM

General

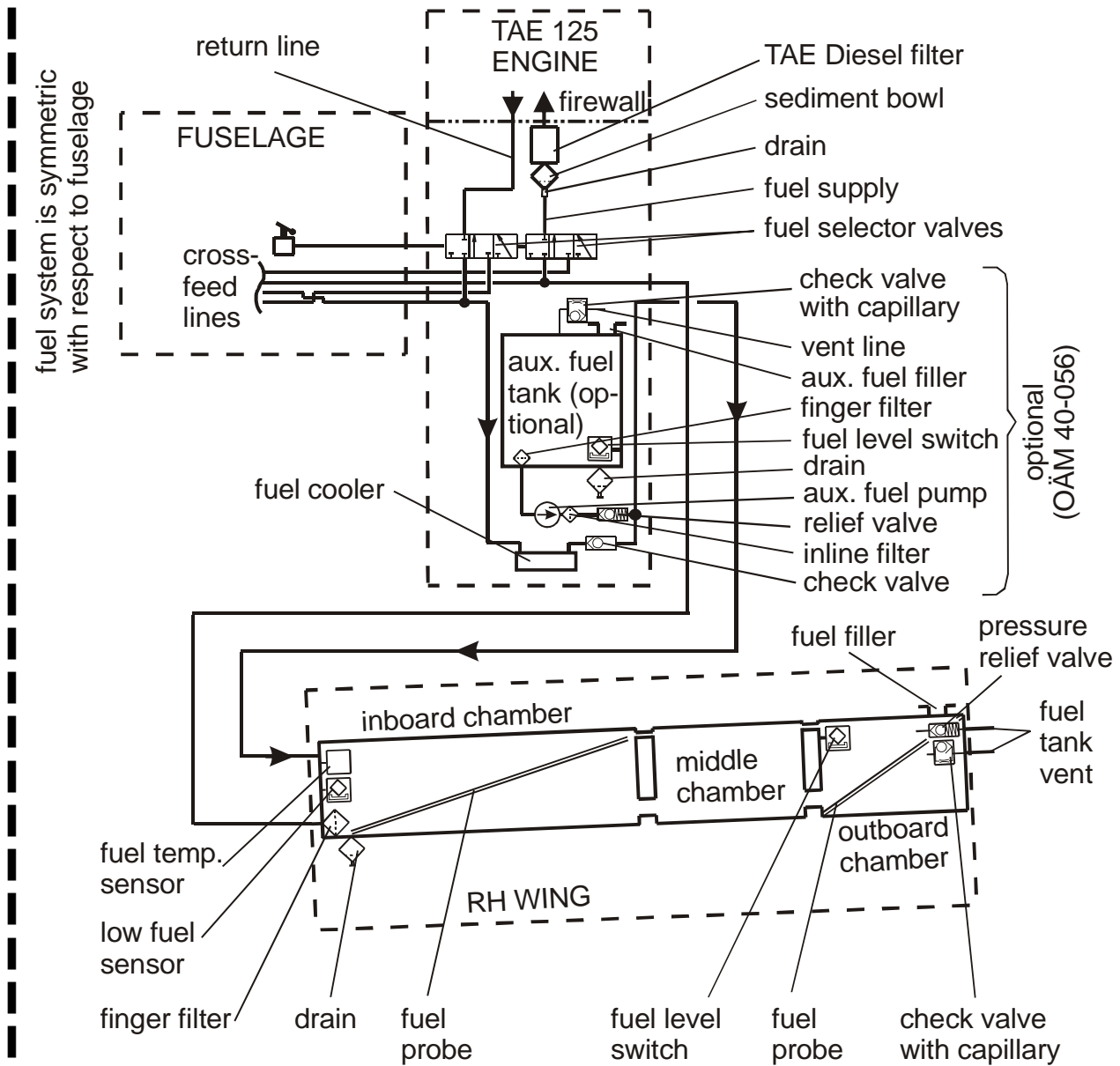

Fuel is stored in the tanks which are located in the wings.

Normally fuel for the right engine is taken from the right wing main tank and for the left engine from the left wing main tank.

On each engine fuel is injected with high pressure directly into the cylinders. The injection nozzles (one per cylinder) are supplied with fuel by the common rail. Pressure inside the rail is generated by a high pressure pump which receives fuel from a low pressure pump. Depending on the power setting the rail pressure is controlled by the ECU through an electric valve. Both pumps are powered mechanically by the engine. Fuel that is not injected is fed back into the appropriate wing tank.

Both sides of the fuel system are interconnected by crossfeed lines.

- In each engine nacelle an auxiliary fuel tank may be installed (OÄM 42-056 carried out).

Fuel selector valves

For each engine one fuel selector valve is provided. The control levers for the fuel selector valves are situated on the center console behind the power levers. The positions are ON, Crossfeed and OFF. During normal operation each engine takes the fuel from the tank on the same side as the engine. When Crossfeed is selected, the engine will draw fuel from the tank on the opposite side in order to extend range and keep fuel weight balanced during single engine operation. With the fuel selector valve both the feeding and the return line are switched.

The desired position is reached by pulling the lever back. To reach the OFF position a safety guard must be twisted. This is to ensure that this selection is not made unintentionally.

NOTE

If one engine is inoperative the fuel selector valve for this engine must be in the OFF position.

CAUTION

Do not operate with both fuel selector valves in Crossfeed Position. Do not take-off with a fuel selector valve in Crossfeed Position.

CAUTION

Do not shut down an engine with the fuel selector valve. The high pressure fuel pump can otherwise be damaged.

Scheme of the fuel selector valve positions:

Possible operating modes of the three fuel selector valve positions are outlined systematically in the following scheme. The figures below show fuel flows for the RH engine (fuel flows LH are alike):

figure 1:
normal
operation

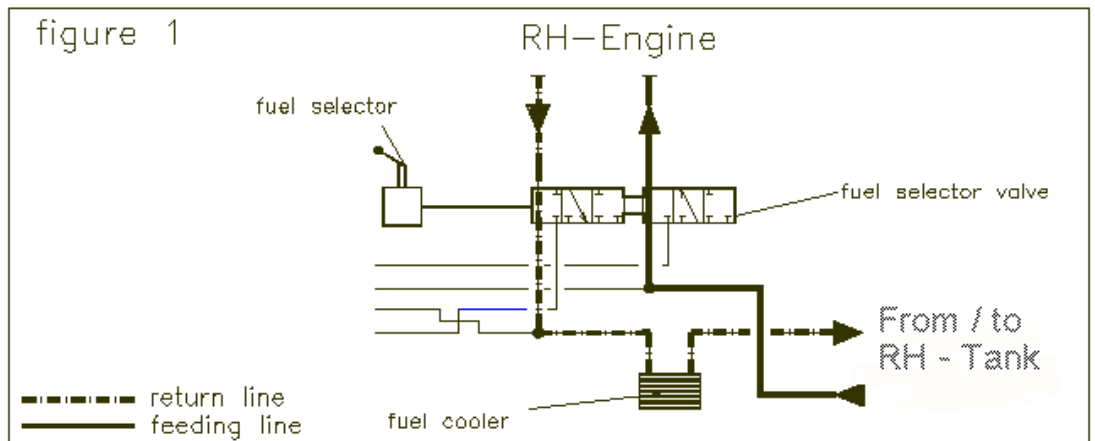

figure 2:
crossfeed
operation

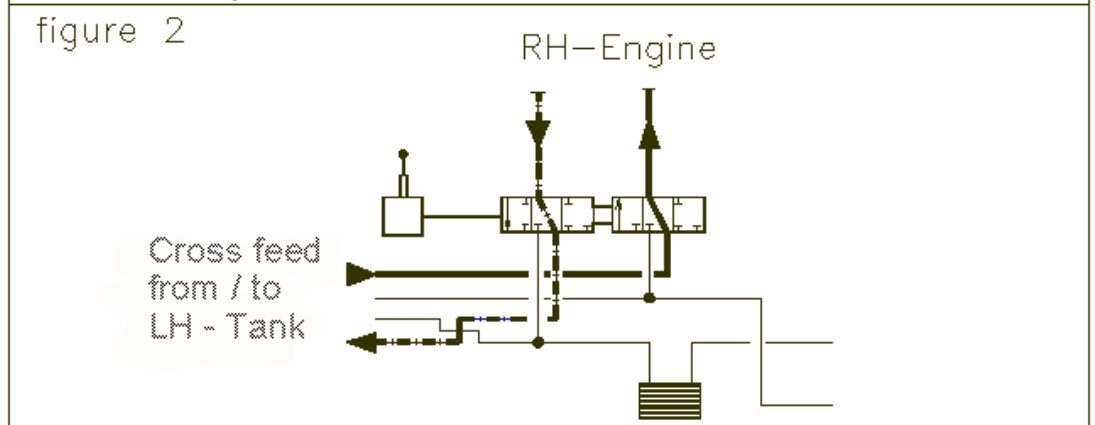
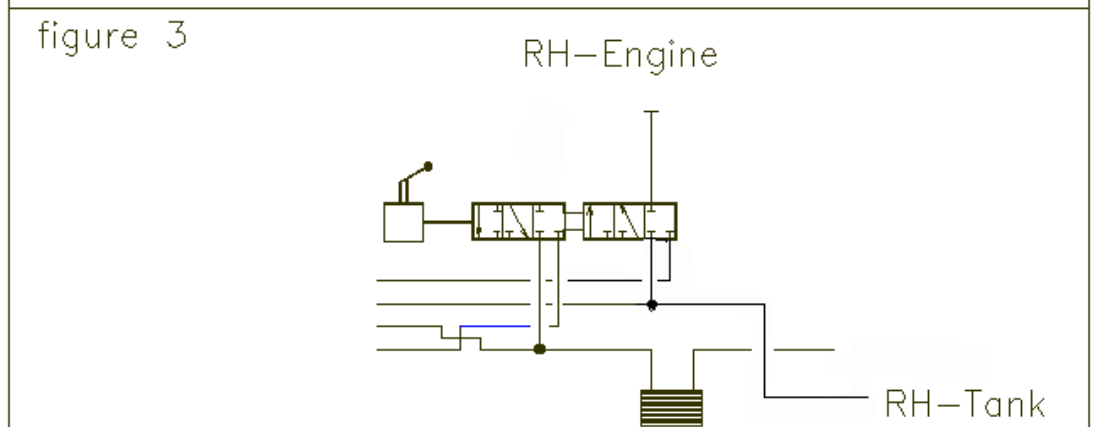

figure 3:
shut-off
position



With the LH fuel selector valve in Crossfeed position, the fuel from the RH tank is transferred to the LH engine. Depending on the position of the RH fuel selector valve, the RH tank then feeds both engines (as shown in figure 4 below) or only the LH engine, when the fuel selector valve of the RH engine is in shut-off position (as shown in figure 5 below).

figure 4: fuel selector valve RH normal operation position, fuel selector valve LH Crossfeed position

figure 5: fuel selector RH valve shut-off position, fuel selector valve LH Crossfeed position

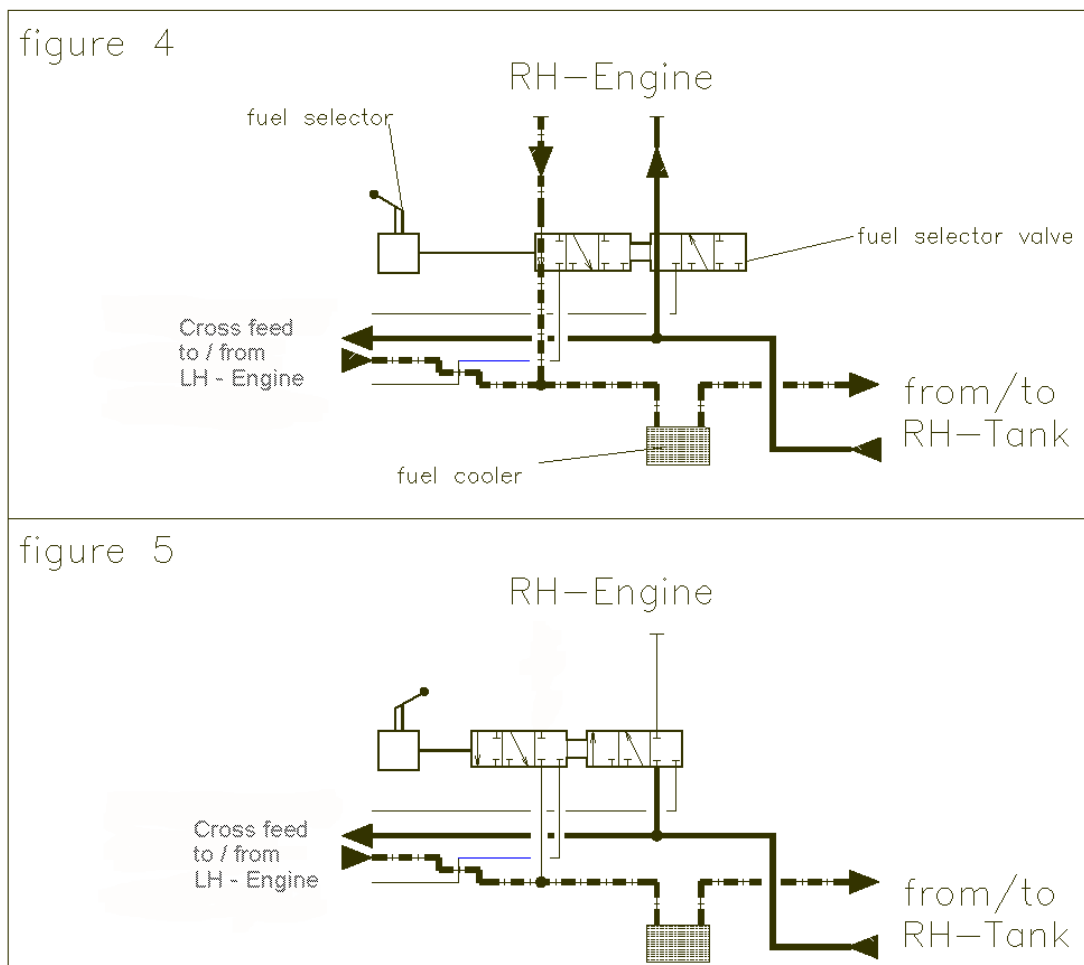

Main fuel tanks

Each tank consists of three aluminum chambers which are connected by a flexible hose. The tank is filled through a filler in the outboard fuel chamber. Only four liters (1 US gal) of fuel in each wing are unusable, so that a total quantity of 96 liters (25.4 US gal) in each wing is usable.

There are two tank vents. One includes a check valve with a capillary and one includes a relief pressure valve, which operates at 150 mbar (2 psi) and allows fuel and air to flow to the outside with higher internal pressure. The relief pressure valve protects the tank against high pressure, if the tank was overfilled in case of an auxiliary fuel transfer failure. The check valve with capillary allows air to enter the tank but prevents flow of fuel to the outside. The capillary equalizes the air pressure during climb. The hose terminals are located on the underside of the wing, approximately 2 meters (7 ft) from the wing tip.

In each tank a coarse filter (finger filter) is fitted before the outlet. To allow draining of the tank, there is an outlet valve at its lowest point.

At the lowest point in each side of the fuel system a fuel filter with a drain valve is installed. This drain valve can be used to remove water and sediment which has collected in the fuel system. The drain valves are fitted in each nacelle behind the firewall, approximately 15 cm (0.56 ft) backward of the wing leading edge.

Fuel quantity indication

Two capacity probes measure the fuel quantity in each main tank. The indication is provided by the G1000 flight display. Information about fuel consumption can be found in Chapter 5 - PERFORMANCE.

Auxiliary fuel tanks (if installed)

The auxiliary fuel tanks are optional equipment (OÄM 42-056).

Description

The auxiliary fuel tanks are installed in the rear section of the engine nacelles, above the wing main spars. Each auxiliary fuel tank has a filler cap located on the top surface of the nacelle. The additional fuel capacity is 13.7 US gallons (52 liters) per side. The total fuel capacity (main fuel tanks and auxiliary fuel tanks) is 39.7 US gallons (150.4 liters) per side.

The fuel supply connection attaches to a finger filter mounted at the rear of the auxiliary fuel tank. Each auxiliary fuel tank has a fuel transfer pump which pumps fuel into the related main fuel tank.

The vent line for the auxiliary fuel tank has a check valve with capillary. It allows air to enter the tank but prevents flow of fuel to the outside. The capillary equalizes the air pressure during climb. A fuel drain valve is located at the rear of each auxiliary tank.

Operation

Two FUEL TRANSFER switches in the cockpit are used to activate the fuel transfer pumps. The switches are located behind the elevator trim wheel on the center console. Both switches are intended to be used simultaneously to prevent the airplane from additional lateral imbalance. The fuel transfer pump pumps the fuel from the auxiliary fuel tank into the related main fuel tank. Fuel level switches shut this pump off automatically when the auxiliary fuel tank is empty or when the main fuel tank is full. During operation of the pumps an advisory alert on the Garmin G1000 indicates that the fuel transfer is in progress.

If the auxiliary fuel tank is empty, a caution alert appears on the Garmin G1000. In this case the fuel pumps must be switched OFF.

When one fuel transfer pump is defective, the fuel stored in the related auxiliary fuel tank is not available. For use of the remaining fuel pump refer to Section 4B.10 - L/R FUEL TRANSFER FAIL. The flight plan must be amended accordingly.

The fuel transfer pumps are electrically connected to the LH Main Bus and protected by a 5A circuit breaker, if no Ice Protection System (OÄM 42-053) is installed.

If the Ice Protection System is installed, both Systems are protected by a 10 A circuit breaker and an additional 7A fuse for the fuel transfer pumps. The circuit breaker is labeled XFER PUMP/DE ICE.

Alternate means for fuel quantity indication for the fuel tank:

The alternate means for fuel quantity indication allows the fuel quantity in the tank to be determined during the preflight inspection. It functions according to the principle of communicating containers. The fuel quantity measuring device has a recess which fits the airfoil of the wing in front of the fuel tank drain, which lies approximately 10 cm (4 in) outboard of the engine nacelle. The metal connector is pressed against the drain of the tank. The amount of fuel in the tank can now be read off from the vertical ascending pipe.

For an exact indication the airplane must stand on level ground and the measuring device must be held vertically.

The designated location for the fuel quantity measuring device is a bag on the rear side of the pilot seat.

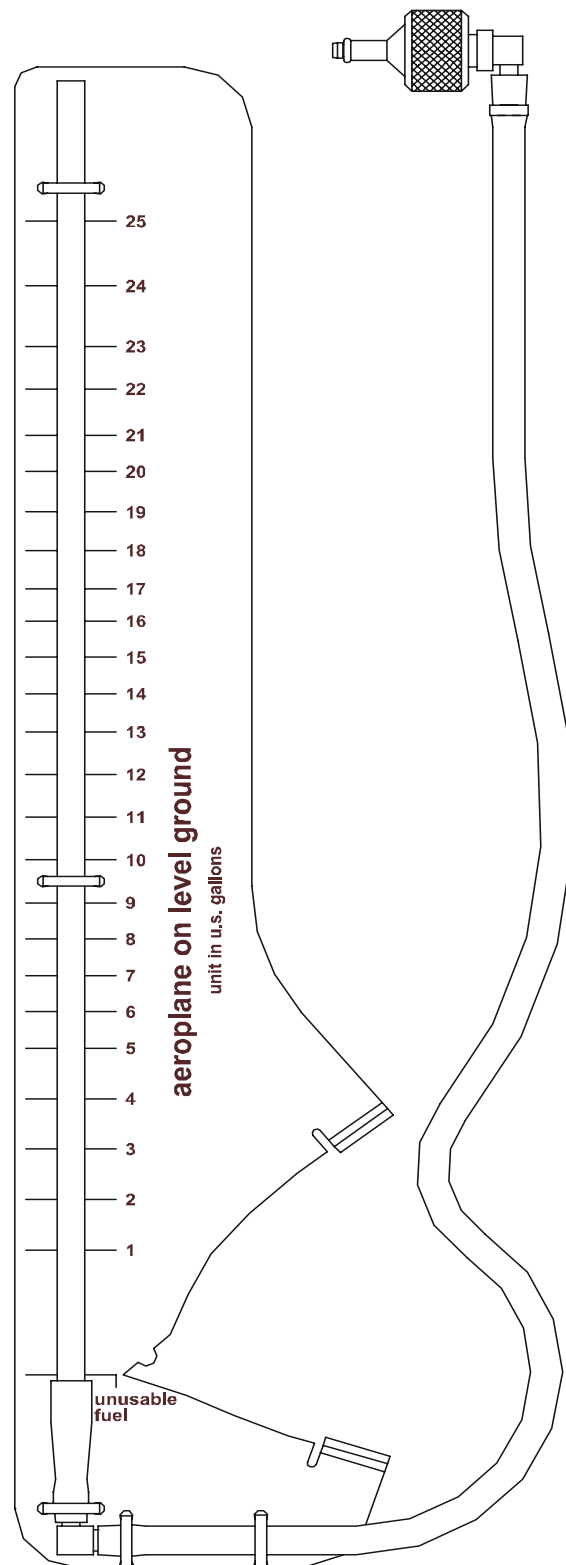

Fuel temperature

A fuel temperature sensor measures the fuel temperature in each main tank. The indication is provided by the G1000 flight display. Information about fuel temperature limitations can be found in Chapter 2 - OPERATING LIMITATIONS.

The lower yellow bar indicates that the airplane is not ready for take-off if Diesel Fuel or a blend of Diesel Fuel with Jet Fuel is used (approved only if MÄM 42-037 is incorporated). If the fuel grade is uncertain, take-off is not allowed in this temperature range either.

In the temperature range below -5 °C (23 °F) the engine must not be started if Diesel Fuel or a blend of Diesel Fuel with Jet Fuel is used. If the fuel blend is uncertain, the engine must not be started in this temperature range either.

If the airplane is being operated with Jet Fuel, operation in the yellow temperature range is permissible.

Fuel grade

Approved fuel grades are listed in Section 2.14. As the fuel grade is important concerning operating temperature limitations, the pilot must be sure about the fuel grade. Cold Diesel Fuel tends to flocculate, which can lead to clogging of the fuel filter. The fuel filter is not heated.

If the airplane is operated in a cold environment, it must be changed from Diesel Fuel operation to Jet Fuel operation. To ensure that no blend of Jet Fuel with Diesel Fuel is in one of the tanks, each tank must be refilled at least twice with more than 65 liters (17.2 US gal) of Jet Fuel. Otherwise both tanks must be drained before refueling with Jet Fuel.

NOTE

In order to provide information about the fuel grade it is recommended to enter the fuel grade in the airplane log each time fuel is refilled.

CAUTION

If the airplane is operated with Diesel Fuel or a blend of Diesel Fuel with Jet Fuel the use of the auxiliary tanks, if installed (OÄM 42-056), is not permitted.

7.9.6 COOLING SYSTEM

Each engine is liquid cooled. The liquid cooling system consists of a radiator and a bypass to this radiator. The bypass is in operation when coolant temperatures are low. It therefore allows the engine to warm-up quickly. Upon reaching a certain temperature (approximately 88 °C or 190 °F) the radiator is activated by a thermostatic valve. Additionally a coolant to air heat exchanger is provided for the cabin heat system. The flow through the heat exchanger is independent of the coolant temperature. An expansion tank helps to adjust the pressure in the system. The system is protected against overpressure by means of a pressure relief valve.

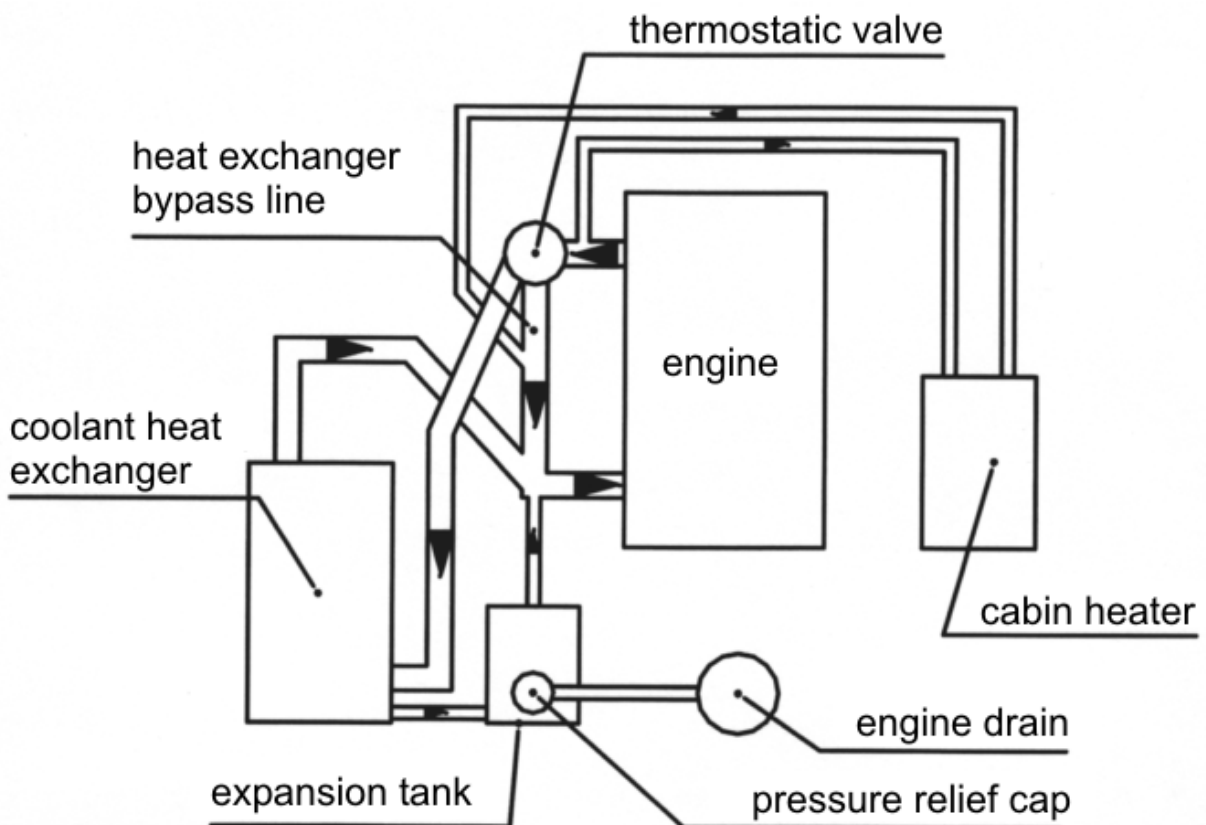

7.9.7 OIL SYSTEMS

Each engine has two separate oil systems.

Lubrication system (engine and turbo-charger)

The engine lubrication is a wet sump lubrication system. The oil is cooled by a separate cooler on the underside of the engine.

A dip-stick is provided to check the oil quantity through an inspection hole in the upper cowling. If required, oil can also be filled in there (for approved oil grades refer to Section 2.4 - POWER-PLANT LIMITATIONS).

Gearbox and propeller governor system

The second oil circuit lubricates the gearbox and serves the governor system and the regulation of the propeller.

The gearbox oil quantity can be checked with the help of an inspection glass which can be reached through an inspection hole on the front side of the lower cowling.

CAUTION

If the gearbox oil quantity is too low, an unscheduled maintenance is necessary (for approved oil grades refer to Section 2.4 - POWER-PLANT LIMITATIONS).

7.9.8 TURBO-CHARGER SYSTEM

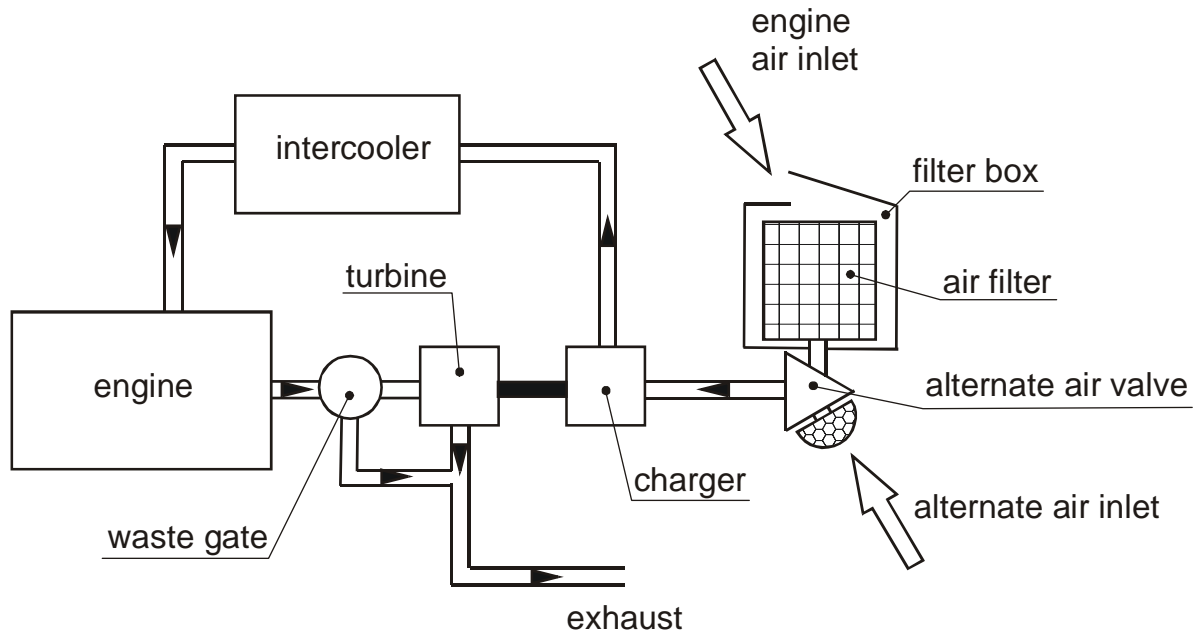

The exhaust system contains a manifold which collects exhaust gases from the outlets of the cylinders and feeds them to the turbine of the turbo charger. Behind the turbine the exhaust gases are guided through the lower cowling to the exterior of the airplane. Excess exhaust gases bypass the turbine. The bypass is controlled by the ECU through the waste gate valve. A manifold pressure sensor behind the compressor allows the ECU to calculate the correct position of the waste gate valve. This prevents excessive manifold pressures at low density altitudes. The intake air is compressed in the compressor which is driven by the turbine, and is subsequently cooled down in the intercooler to increase power. Cooling the air increases efficiency through the higher density of the cooler air.

7.9.9 FIRE DETECTION SYSTEM

The fire detection system in the DA 42 consists of an overheat detector in the hot area of each engine. In case of an increase of the engine compartment temperature above 250 °C (480 °F) the overheat detector closes the electric circuit and a warning message appears in the annunciation window of the G1000 PFD.

To test the fire detectors (refer to Section 4A.6.1 - PREFLIGHT INSPECTION) push the test button located next to the gear selector switch. An aural alert and the fire warning message for the LH and RH engine should appear in the annunciation window of the G1000 PFD.

CAUTION

If the aural alert or the warning does not appear, an unscheduled maintenance is necessary.

7.10 ELECTRICAL SYSTEM

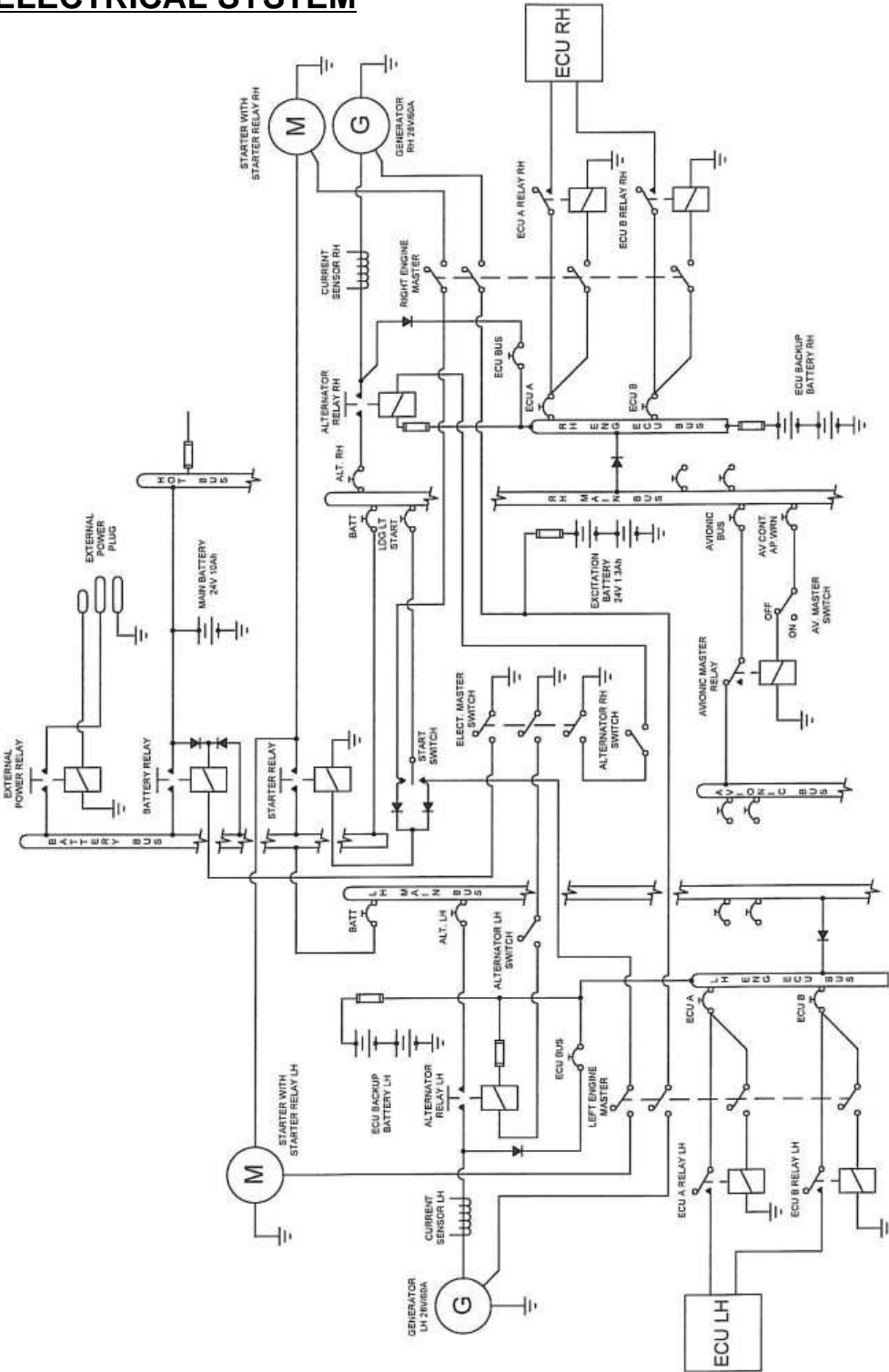

7.10.1 GENERAL

The DA 42 has 28 Volt DC system, which can be sub-divided into:

- Power generation
- Storage
- Distribution
- Consumers

Power generation

Power generation is provided by two 60 Ampère alternators (generators) which are mounted on the bottom left side of each engine. The alternators are driven by a flat belt.

The power output line of the left hand alternator is connected to the 'LH main bus' via the LH alternator relay and a 70 Ampère circuit breaker. The power output line of the RH alternator is connected to the 'RH main bus' via the RH alternator relay and a 70 Ampère circuit breaker. Both 'main busses' are connected to the 'battery bus' via a 90 Ampère circuit breaker.

Both generator power output lines also run through a current sensor for each alternator, which provides an indication of the power being supplied to the electrical system by an alternator including the current for battery charging on the G1000. In the event of a main battery failure the field of each alternator is energized by two 12 V, 1.3 Ah sealed lead acid batteries ('excitation'-battery) connected in series, which are installed in the nose baggage compartment. The 'ENGINE MASTER LH (RH)'-switches connect the 'excitation' battery to the alternator field via a 5 Ampère fuse.

If MÄM 42-240 or OÄM 42-074 or OÄM 42-129 are carried out:

The 'ENGINE MASTER LH (RH)'-switches connect the 'excitation' battery to the alternator field via a 10 Ampère fuse.

Alternator control:

Each alternator has an alternator control unit. It measures the alternator output voltage and controls the current through the alternator field coils via a pulse-width modulated signal. To keep the output voltage stable in all load and speed situations, the alternator field signal is modulated accordingly.

The alternator control unit includes a comprehensive set of diagnostic functions that will warn the operator using a caution message (L/R ALTN FAIL) on the G1000 PFD in case of over- or undervoltage as well as a couple of other internal warning levels.

Load Balancing: The alternator control unit supports load balancing across the two alternators via the internal alternator temperature. The temperature is measured and the alternator control unit slightly decreases alternator voltage output at higher internal alternator temperatures. Thus the load is partly shifted to the alternator with the lower internal temperature. This system is able to balance the actual load within a few amps between the two alternators installed.

Storage

'Main'-battery power is stored in a 24 V, 10 Ah lead-acid battery mounted on the right-aft side of the front baggage compartment. The 'main' battery is connected to the 'hot battery bus' and to the 'battery bus' via the 'battery'-relay which is installed in the relay junction box on the center-aft side of the front baggage compartment.

The 'battery'-relay is controlled with the 'ELECTRIC MASTER'-switch which is located on the left-hand side of the instrument panel.

In addition, a non-rechargeable dry battery is installed as a further source of power for the attitude gyro (artificial horizon) and the flood light. When the EMERGENCY switch is set to ON, these two systems are supplied with power for at least 1.5 hours, independent of all other electrical consumers. During each 100 hour inspection, this battery is checked for proper functioning. Every 2 years or after use (broken seal on the switch) the battery package must be replaced.

Distribution

Electrical power is distributed via the 'hot battery bus', the 'battery bus', the 'LH (RH) ECU-bus', the 'LH (RH) main bus', and the 'avionic bus'.

Hot battery bus:

The 'hot battery bus' is directly connected to the 'main' battery and cannot be disconnected from the 'main'-battery. The 'hot battery bus' provides power to the pilot map/reading light and ELT RCPI unit which are protected by their own fuses.

Battery bus:

The 'battery bus' is connected to the 'main' battery via the 'battery'-relay which can be controlled by the 'ELECTRIC MASTER' switch. The 'battery bus' provides power to the 'LH (RH) main bus' and heavy duty power to both starters.

ECU bus:

The 'LH (RH) ECU bus' is connected to the 'LH (RH) main bus' via a diode and connected to the power output line of the alternator via diode and a 30 Ampère circuit breaker and provides power for the ECU A and ECU B via the 'LH (RH) ECU A (B)'-Relays which are controlled by the 'LH (RH) ENGINE MASTER' switch. The 'LH (RH) ENGINE MASTER'-switch must be set to 'ON' to connect the ECU A and ECU B to the 'ECU bus'.

To support the alternator electrical power supply to the ECU's in case of a malfunction of the main battery, additional sealed-lead-acid batteries (ECU backup battery) are connected to the RH and LH ECU bus.

If OÄM 42-129 is carried out:

These batteries are able to provide 30 minutes of engine operation in case of a complete airplane electrical failure. Both engines may stop if the 30 minutes have elapsed.

Main bus:

The 'LH (RH) main bus' is connected to the 'battery bus' via a 90 Ampère circuit breaker. The 'LH main bus' provides power to the consumers directly connected to the 'LH main bus'. The 'RH main bus' provides power to the consumers directly connected to the 'RH main bus' and the 'avionic bus' via the 'avionics master'-relay.

The 'AVIONIC MASTER'-switch must be set to 'ON' to connect the 'RH main bus' to the 'avionic bus'.

Consumers

The individual consumers (e.g. radio, position lights, etc.) are connected to the appropriate bus via automatic circuit breakers.

Designations and abbreviations used to identify the circuit breakers are explained in Section 1.5 DEFINITIONS AND ABBREVIATIONS.

Voltmeter

The voltmeter displays the voltage of the electrical system. Under normal operating conditions the alternator voltage is shown, otherwise it displays the 'main' battery voltage.

Ammeter

The ammeter displays the intensity of current which is supplied to the electrical system by the LH (RH) alternator.

Landing and taxi lights

Landing and taxi lights are built into the wing center section, and are each operated by means of a switch (LANDING, TAXI) located on the row of switches on the instrument panel.

Position and strobe lights

Combined position and strobe lights (anti collision lights) are installed on both wing tips. Each system is operated by a switch (POSITION, STROBE) located on the row of switches on the instrument panel.

Flood light

A two-dimensional light emitter is mounted above the instrument panel. It illuminates the instrument panel as well as all levers, switches, etc. The flood light is switched on and its brightness is adjusted by means of a rotary button (FLOOD) in the LH section of the instrument panel.

Instrument lighting

With a rotary button (INSTRUMENT) in the LH section of the instrument panel the internal lighting of the instruments is switched on and its brightness is adjusted.

Pitot heating

The Pitot probe, which provides measurement for the Pitot-static system, is electrically heated. The heating is activated with a switch (PITOT HEAT) located on the row of switches on the instrument panel. The temperature is automatically kept constant by means of a thermal switch on the Pitot probe, and as an additional safety measure a thermal fuse is built in. If this thermal fuse is activated, the Pitot heating can no longer be switched on, and the PITOT HT fail will be displayed. In this case the system should be serviced. The PITOT HT OFF is on if the Pitot heating is switched off.

External power socket

The DA 42 has an external 28 Volt DC power socket located on the lower surface of the fuselage nose section. When external power is connected, the control relay is energized and the external power comes online.

The socket itself has three pins:

- a large negative pin
- a large positive pin
- a small positive pin

A diode protects the system from reverse polarity.

7.10.2 ENGINE CONTROL UNIT / ECU

Engine control and regulation

The ECU monitors, controls and regulates all important parameters for engine operation.

Sensors installed are:

- Oil temperature (lubrication system engine) / OIL TEMP
- Oil pressure (lubrication system engine) / OIL PRES
- Coolant temperature / COOLANT TEMP
- Gearbox temperature / GEARBOX
- Camshaft RPM (twice)
- Crankshaft RPM (twice)
- Fuel pressure in the common rail
- Manifold pressure
- Manifold air temperature
- Ambient air pressure
- Propeller governor / oil pressure
- Power lever position (twice)
- Voltage
- Starter switch signal
- Fuel pressure
- 'ECU Swap'-switch signal
- 'ECU Test'-switch signal

In accordance with the received signals and a comparison with the programmed characteristic diagrams the necessary inputs are calculated and transmitted by the following signal lines to the engine:

- Activation of starter (relay)
- Signal for propeller governor pressure valve
- Signal for the rail-pressure regulation valve
- Signal for each of the 4 injection nozzles
- Activation of the glow plugs
- Signal for the waste gate valve

The following alerts are displayed on PFD of the G1000:

- Glow sparks active
- Status ECU A
- Status ECU B

Normally each engine is controlled and regulated by the appropriate ECU A. The ECU B is a backup system to ensure redundancy. In case of an internal error during operation or the loss of a sensor signal the system automatically switches to ECU B. If the loss of the sensor signal was the cause for the error, the system automatically switches back to ECU A.

A fault in one of the ECU's is indicated by a caution message on the PFD (L/R ECU A/B FAIL). In case of minor faults, the annunciation can be reset once by pressing the ECU TEST button for more than 2 seconds. However, the annunciation will re-appear upon the next attempt to start the engine. After the indication of the L/R ECU A/B FAIL caution message, the engine must be serviced, even if the caution message could be reset.

7.10.3 WARNING, CAUTION AND ADVISORY MESSAGES

Crew Alerting System (CAS)

The G1000 Crew Alerting System (CAS) is designed to provide visual and aural alerts to the flight crew. Alerts are divided into three levels as follows:

WARNING

CAUTION

ADVISORY

Crew alerts will appear in the Alerts Window on the PFD. In this window Warnings will appear at the top, followed by Cautions and Advisories, respectively. Within the criticality levels, messages will appear from newest (top) to oldest (bottom).

At the low right corner of the display there is a MSG (Message) soft key. The MSG key provides two functions in the CAS:

1. Pressing the MSG key acknowledges a new master warning / caution / advisory indication.
2. An additional MSG key press with no master alert indication active will open a pop-up Auxiliary Flight Display (AFD) page that contains information for all active alerts.

This structure allows the crew to scroll through all system alerts if the Alerts Window overflows. This approach displays the most critical alerts close to the pilot's primary field of view at all times, with the option of allowing lower criticality alerts to overflow and be accessible from the pop-up AFD page/window.

Alert levels

Level	Text Color	Importance	Audible Tone
Warning	Red	May require immediate corrective action	Warning chime tone which repeats without delay until acknowledged by the crew
Caution	Amber	May require future corrective action	Single warning chime tone
Annunciation Advisory	White		None
Message Advisory	White		None
Safe Operation Annunciation	Green	Lowest	None

Warning alerts on the G1000

Warning alerts	Meaning / Cause
L/R ENG TEMP	The annunciation is active when the engine coolant temperature is greater than 105 °C.
L/R OIL TEMP	The annunciation is active when the engine oil temperature is greater than 140 °C.
L/R OIL PRES	The annunciation is active when the engine oil pressure is less than 1 bar.
L/R FUEL TEMP	The annunciation is active when the fuel temperature is greater than 75 °C.
L/R GBOX TEMP	The annunciation is active when the gearbox oil temperature is greater than 120 °C.
L/R ALTN AMPS	The annunciation is active when the alternator load is greater than 60 amps.
L/R ENG FIRE	The annunciation is active when an engine fire is detected.
L/R STARTER	This annunciation is used to indicate to the pilot that the starter is engaged when it should not be.
DOOR OPEN	The annunciation is used to indicate to the pilot if the baggage-, canopy- or rear door is open.
POSN ERROR	The annunciation is active when the G1000 will no longer provide GPS based navigational guidance.
ATTITUDE FAIL	The annunciation is active when the display system is not receiving attitude reference information from the AHRS.
AIRSPEED FAIL	The annunciation is active when the display system is not receiving airspeed input from the air data computer.
ALTITUDE FAIL	The annunciation is active when the display system is not receiving altitude input from the air data computer.
VERT SPEED FAIL	The annunciation is active when the display system is not receiving vertical speed input from the air data computer.

Warning alerts	Meaning / Cause
HDG	The annunciation is active when the display system is not receiving valid heading input from the AHRS.
WARN	This annunciation constitutes a RAIM position warning. The nav deviation bar is removed.

Audible warning alerts

Warning alerts	Meaning / Cause
Landing Gear Retracted	A warning chime tone which repeats without delay is active when the landing gear is retracted while the flaps move into the LDG position or when the POWER lever is placed in a position below 25 %.

Caution alerts on the G1000

Caution alerts	Meaning / Cause
L/R ECU A FAIL or L/R ECU B FAIL	The annunciation is active when a fault in ECU A or ECU B has occurred. In case of minor faults, the annunciation can be reset once by pressing the ECU TEST button for more than 2 seconds. However, the annunciation will re-appear upon the next attempt to start the engine.
L/R FUEL LOW	The annunciation is active when the fuel quantity is below 4 ± 1 gal usable fuel.
L/R VOLTS LOW	The annunciation is active when bus voltage is less than 25 volts.
L/R ALTN FAIL	The annunciation is active when the alternator has failed.
L/R COOL LVL	The annunciation is active when engine coolant level is low.
PITOT FAIL	The annunciation is active when the Pitot heater is failed.
PITOT HT OFF	The annunciation is active when the Pitot heat is off.
STAL HT FAIL	The annunciation is active when the stall heater is failed.
STAL HT OFF	The annunciation is active when the stall heater is off.
STICK LIMIT	Control stick limiting system (variable elevator stop) has failed.
L/R AUX FUEL E	This annunciation can only occur when the auxiliary fuel tank system (optional) is installed. The annunciation is active when the L/R auxiliary fuel tank is empty and the FUEL TRANSFER pump is ON.
INTEG RAIM not available	The annunciation is active when RAIM (Receiver Autonomous Integrity Monitor) is not available.
AHRS ALIGN: Keep Wings Level	The annunciation is active when the AHRS (Attitude and Heading Reference System) is aligning.
CHECK GEAR (if installed)	Landing gear is not down and locked.

Annunciation advisory alerts on the G1000

Advisory alerts	Meaning / Cause
L/R GLOW ON	The annunciation is active when the glow plugs are powered.
L/R FUEL XFER	The annunciation is active when fuel transfer from auxiliary to main tank is in progress.

Message advisory alerts on the G1000

Advisory alerts	Meaning / Cause
PFD FAN FAIL	The annunciation is active when the PFD fan is inoperative.
MFD FAN FAIL	The annunciation is active when the MFD fan is inoperative.
GIA FAN FAIL	The annunciation is active when the GIA fan is inoperative.

7.11 PITOT-STATIC SYSTEM

Total pressure is measured at the leading edge of a Pitot probe under the left wing. Static pressure is measured at two orifices at the lower and rear edges of the same probe. To protect against dirt and condensation there are filters in the system, which are accessible from the wing root. The Pitot probe is electrically heated.

With the alternate static valve, the static pressure in the cabin can be used as static pressure source in the event of a failure of the Pitot-static system.

■ If an Autopilot System is installed, additional static sources may be installed.

7.12 STALL WARNING SYSTEM

The lift detector of the DA 42 is located on the front edge of the left wing below the wing chord line. It is supplied electrically and provides a stall warning, before the angle of attack becomes critical. The stall status is announced to the pilot by a continuous sound in the cockpit.

The lift detector vane, the mounting plate and the complete housing are heated to prevent icing. Heating is engaged together with the Pitot heating.

7.13 GARMIN G1000 INTEGRATED AVIONICS SYSTEM

7.13.1 GENERAL

The Gamin G1000 is a fully integrated flight, engine, communication, navigation and surveillance instrumentation system. This Integrated Avionics System consists of a Primary Flight Display (PFD), a Multifunction Display (MFD), an Audio Panel, an Attitude and Heading Reference System (AHRS), an Air Data Computer (ADC) and the sensors and computers to process flight and engine information for display to the pilot. The system contains dual GPS receivers, dual VOR/ILS receivers, dual VHF communications transceivers, a transponder, and an integrated annunciation system to alert the pilot of certain abnormal conditions.

A remote avionic box is located behind the aft baggage compartment frame. A push-to-talk (PTT) button for the COM portion of the G1000 is mounted on the end of each control stick. There are connection facilities for up to 4 headsets between the front seats.

Refer to the Garmin G1000 Cockpit Reference Guide, Garmin P/N 190-00406-00, dated September, 2004, and Pilot's Guide, P/N K00-00138-00, dated September, 2004, for complete descriptions of the G1000 system and operating procedures.

NOTE

Near the DME ground station, it can happen under certain adverse conditions that the Bendix/King KN 63 DME loses the direct signal from the ground station and locks onto an "echo". This will result in an inaccurate indication of the distance.

NOTE

During retraction and extension of the landing gear the ADF-indication may be inaccurate.

7.13.2 PRIMARY FLIGHT DISPLAY (PFD)

The Primary Flight Display (PFD; see figure below) typically displays airspeed, attitude, altitude, and heading information in a traditional format. Slip information is shown as a trapezoid under the bank pointer. One width of the trapezoid is equal to a one ball width slip. Rate of turn information is shown on the scale above the compass rose; full scale deflection is equal to a standard rate turn. The following controls are available on the PFD (clockwise from top right):

- * Communications frequency volume and squelch knob
- * Communications frequency set knobs
- * Communications frequency transfer button
- * Altimeter setting knob (baro set)
- * Course knob
- * Map range knob and cursor control
- * FMS control buttons and knob
- * PFD softkey buttons, including master warning/caution acknowledgment
- * Altitude reference set knob
- * Heading bug control
- * Navigation frequency transfer button
- * Navigation frequency set knobs
- * Navigation frequency volume and Identifier knob



The PFD displays the crew alerting (annunciator) system. When a warning or caution message is received, a warning or caution annunciator will flash on the PFD, accompanied by an aural tone. A warning is accompanied by a repeating tone, and a caution is accompanied by a single tone. Acknowledging the alert will cancel the flashing and provide a text description of the message. Refer to Chapter 3 - EMERGENCY PROCEDURES, Chapter 4B - ABNORMAL OPERATING PROCEDURES, and Section 7.10.3 - WARNING, CAUTION AND ADVISORY LIGHTS.

Advisory messages related to G1000 system status are shown in white and are accompanied by a white flashing ADVISORY alert. Refer to the G1000 Pilot's Guide and Cockpit Reference Guide for descriptions of the messages and recommended actions (if applicable).

Trend vectors are shown on the airspeed and altimeter displays as a magenta line predicting 6 seconds at the current rate. The turn rate indicator also functions as a trend indicator on the compass scale.

The PFD can be displayed in a composite format for emergency use by pressing the DISPLAY BACKUP button on the audio panel. In the composite mode, the full crew alerting function remains, but no map functions are available.

7.13.3 MULTI-FUNCTION DISPLAY (MFD)

The Multi-Function Display (MFD) typically displays engine data, maps, terrain, traffic and topography displays, and flight planning and progress information. The display unit is identical to the PFD and contains the same controls as previously listed.

Engine instruments are displayed on the MFD. Discrete engine sensor information is processed by the Garmin Engine Airframe (GEA) sub-system. When an engine sensor indicates a value outside the normal operating range, the legend will turn yellow for caution range, and turn red and flash for warning range.

Also refer to Section 7.9.4 - ENGINE INSTRUMENTS.

7.13.4 AUDIO PANEL

The audio panel contains traditional transmitter and receiver selectors, as well as an integral intercom and marker beacon system. The marker beacon lights appear on the PFD. In addition, a clearance recorder records the last 2 ½ minutes of received audio. Lights above the selections indicate what selections are active. Pressing the red DISPLAY BACKUP button on the audio panel causes both the PFD and MFD to display a composite mode.

7.13.5 ATTITUDE AND HEADING REFERENCE SYSTEM (AHRS)

The Attitude and Heading Reference System (AHRS) uses GPS, rate sensors, air data, and magnetic variation to determine pitch and roll attitude, sideslip and heading. Operation is possible in a degraded mode if the system loses any of these inputs. Status messages alert the crew of the loss of any of these inputs. The AHRS will align while the airplane is in motion, but will align quicker if the wings are kept level during the alignment process.

7.13.6 AIR DATA COMPUTER (ADC)

The Air Data Computer (ADC) provides airspeed, altitude, vertical speed, and air temperature to the display system. In addition to the primary displays, this information is used by the FMS and TIS systems.

Intentionally left blank.

CHAPTER 8

AIRPLANE HANDLING, CARE AND MAINTENANCE

	Page
8.1 INTRODUCTION	2
8.2 AIRPLANE INSPECTION INTERVALS	2
8.3 AIRPLANE ALTERATIONS OR REPAIRS	3
8.4 SERVICING	3
8.4.1 REFUELING	3
8.4.2 ENGINE OIL LEVEL CHECK	4
8.4.3 GEARBOX OIL LEVEL CHECK	4
8.4.4 TIRE INFLATION PRESSURE CHECK	5
8.5 GROUND HANDLING / ROAD TRANSPORT	6
8.5.1 GROUND HANDLING	6
8.5.2 PARKING	7
8.5.3 MOORING	9
8.5.4 JACKING	9
8.6 CLEANING AND CARE	10
8.6.1 PAINTED SURFACES	10
8.6.2 CANOPY AND REAR DOOR	11
8.6.3 PROPELLER	11
8.6.4 ENGINE	11
8.6.5 INTERIOR SURFACES	11
8.7 GROUND DE-ICING	12

8.1 INTRODUCTION

Chapter 8 contains the manufacturer's recommended procedures for proper ground handling and servicing of the airplane. The Airplane Maintenance Manual (Doc. No. 7.02.01) lists certain inspection and maintenance requirements which must be followed if the airplane is to retain a new plane performance and reliability.

8.2 AIRPLANE INSPECTION INTERVALS

Inspections are scheduled every 100, 200, 1000 and 2000 hours. Independent of the flight hours an annual inspection must be performed every year. A non-recurring engine inspection must be performed on new engines after 3 to 6 hours. The respective inspection checklists are prescribed in the Airplane Maintenance Manual, Chapter 05.

For maintenance work on engine and propeller, the currently effective Operator's Manuals, Service Instructions, Service Letters and Service Bulletins of TAE and mt-Propeller must be followed. For airframe inspections, the currently effective checklists/manuals, Service Bulletins and Service Instructions of the manufacturer must be followed.

CAUTION

Unscheduled maintenance checks are required after:

- hard landings
- propeller strike
- engine fire
- lightning strike
- occurrence of other malfunctions and damage

Unscheduled maintenance checks are described in the Airplane Maintenance Manual (Doc. No. 7.02.01; Section 05-50).

8.3 AIRPLANE ALTERATIONS OR REPAIRS

Alterations or repairs to the airplane may be carried out only according to the Airplane Maintenance Manual, Doc. No. 7.02.01, and only by authorized personnel.

8.4 SERVICING

8.4.1 REFUELING

WARNING

Do not allow fire, sparks or heat near fuel. Fuel burns violently and can cause injury to persons and damage to the airplane.

WARNING

Do not get fuel on your skin. Fuel can cause skin disease.

WARNING

Connect the airplane and the fuel supply vehicle to electrical ground before refueling. If you do not ground the airplane, static electricity can cause fire during refueling.

WARNING

Make sure that a suitable fire extinguisher is available at all times during refueling.

WARNING

Turn off all ground equipment in the refueling area.

WARNING

Do not operate electrical switches in the airplane during refueling.

CAUTION

Use only approved fuel types given in Chapter 2.

1. Ground the airplane and the fuel supply vehicle electrically.
2. Remove the fuel filler cap (located on top of the outer wing). Check cap retaining cable for damage.
3. Refuel the airplane.
4. Install the fuel filler cap.
5. Repeat steps 2 to 4 for the other wing.
6. Remove the ground cable from the airplane and the fuel supply vehicle.

8.4.2 ENGINE OIL LEVEL CHECK

1. Open the inspection door on top of the upper left cowling.
2. Remove the filler cap.
3. Clean the oil dip-stick.
4. Install the filler cap.
5. Remove the filler cap again.
6. Read the oil level from the dip-stick.
7. If necessary, add engine oil and repeat steps 3 to 6.
8. Install the filler cap.
9. Close the inspection door.
10. Repeat steps 1 to 9 for the other engine.

8.4.3 GEARBOX OIL LEVEL CHECK

1. Open the inspection door on the forward left side of the lower cowling.
2. Check gearbox oil level in inspection window.
3. Close the inspection door.
4. Repeat steps 1 to 3 for the other engine.

8.4.4 TIRE INFLATION PRESSURE CHECK

1. Remove dust cap from valve stem by turning counterclockwise.
2. Connect tire gauge to valve stem, read pressure.
3. Correct pressure if necessary (nose tire 6.0 bar/87 psi, main tires 4.5 bar/65 psi).
4. Install dust cap on valve stem by turning clockwise.

8.5 GROUND HANDLING / ROAD TRANSPORT

8.5.1 GROUND HANDLING

For pushing or pulling the airplane on the ground, it is recommended to use the tow bar which is available from the manufacturer. The tow bar is engaged in the appropriate hole in the nose wheel as shown on the picture.



Tow bar

WARNING

The tow bar must be removed before starting the engine.

CAUTION

The tow bar may only be used for moving the airplane on the ground by hand. After moving the airplane, the tow bar must be removed.

CAUTION

Towing with towing vehicles is not approved.

8.5.2 PARKING

For short term parking, the airplane must be positioned into the wind, the parking brake must be engaged and the wing flaps must be in the retracted position. For extended and unattended parking, as well as in unpredictable wind conditions, the airplane must be anchored to the ground or placed in a hangar. Parking in a hangar is recommended.

Control surfaces gust lock

The manufacturer offers a control surfaces gust lock which can be used to block the primary controls. It is recommended that the control surfaces gust lock be used when parking outdoors, because otherwise the control surfaces can hit the stops in strong tail wind. This can lead to excessive wear or damage.

WARNING

The control surfaces gust lock must be removed before flight.

The control surfaces gust lock is installed as follows:

1. Move the rudder pedals fully forward.
2. Engage the control surfaces gustlock with the pedals.
3. Engage the stick, wrap straps around stick once.
4. Attach the locks and tighten the straps.

For removal reverse the sequence.



8.5.3 MOORING

Near the lower end of the tail fin of the airplane there is a hole which can be used to tie down the airplane to the ground. Also on each wing near the wing tip, an eyelet with a metric M8 thread can be installed and used as tie-down points.

8.5.4 JACKING

The airplane can be jacked at the two jackpoints located on the lower side of the center wing's LH and RH root ribs as well as at the tail fin.

8.6 CLEANING AND CARE

CAUTION

The airplane must be kept clean. The bright surface prevents the structure from overheating.

CAUTION

Excessive dirt deteriorates the flight performance.

8.6.1 PAINTED SURFACES

The entire surface of the airplane is painted with a white weatherproof two component paint. Nevertheless, it is recommended to protect the airplane against moisture and dampness. It is also recommended not to store the airplane outside for long periods of time.

Dirt, insects, etc. can be removed with water alone and if necessary with a mild detergent. An automotive paint cleaner can be used for stubborn spots. For best results, clean the airplane after the day's flying is ended, so that the dirt will not become ingrained.

Oil stains, exhaust stains, etc. on the lower fuselage skin can be removed with a cold detergent. Before starting, ensure that the detergent does not affect the surface finish. Use commercial automotive preservatives without silicone additives to conserve the paint finish.

8.6.2 CANOPY AND REAR DOOR

The canopy, rear door and rear window should be cleaned with 'Plexiklar' or any other acrylic glass detergent if available; otherwise use lukewarm water. Final cleaning should be carried out with a clean piece of chamois leather or soft cloth. Never rub or polish dry acrylic glass.

8.6.3 PROPELLER

Damage and malfunctions during operation must be inspected by authorized personnel.

Surface

The manufacturer uses PU paint or acrylic paint which is resistant to almost any solvent. The blades may be treated with commercial automotive cleaning agents or preservatives. The penetration of moisture into the wooden core must be avoided by all means. Should doubts arise, an appropriately rated inspector must be consulted.

8.6.4 ENGINE

Engine cleaning is part of the scheduled inspections.

8.6.5 INTERIOR SURFACES

The interior should be cleaned using a vacuum cleaner. All loose items (pens, bags etc.) should be removed or properly stored and secured.

All instruments can be cleaned using a soft dry cloth. Plastic surfaces should be wiped clean using a damp cloth without any cleaning agents.

The leather interior should be treated with leather sealer within 3 months since new, and then at intervals of 3 to 6 months. Clean the leather interior with an appropriate mild leather cleaning agent and a soft cleaning brush for leather.

Note that the acrylic glass windows transmit the ultraviolet radiation from the sun.

8.7 GROUND DE-ICING

Approved deicing fluids are:

Manufacturer	Name
Kilfrost	TKS 80
Aeroshell	Compound 07
	AL-5 (DTD 406B)

1. Remove any snow from the airplane using a soft brush.
2. Spray deicing fluid onto ice-covered surfaces using a suitable spray bottle.
3. Use a soft piece of cloth to wipe the airplane dry.

CHAPTER 9

SUPPLEMENTS

	Page
9.1 INTRODUCTION	9-2
9.2 LIST OF SUPPLEMENTS	9-2

9.1 INTRODUCTION

Chapter 9 contains information concerning additional (optional) equipment of the DA 42.

Unless otherwise stated, the procedures given in the Supplements must be applied in addition to the procedures given in the main part of the Airplane Flight Manual.

All approved supplements are listed in the List of Supplements in this Chapter.

The Airplane Flight Manual contains exactly those Supplements which correspond to the installed equipment according to the Equipment Inventory of Section 6.5.

9.2 LIST OF SUPPLEMENTS

Airplane S/N:		Registration:		Date:	
Sup. No.	Title	Rev. No.	Date	applicable	
				YES	NO
A13	Autopilot System, Bendix/King KAP 140	0	01-Dec-2004	<input type="checkbox"/>	<input type="checkbox"/>
S02	Ice Protection System	2	06-Dec-2005	<input type="checkbox"/>	<input type="checkbox"/>
S03	Ice Protection System (Known Icing)	1	12-Jan-2006	<input type="checkbox"/>	<input type="checkbox"/>
S04	Continuous Flow Oxygen System	2	06-Jun-2006	<input type="checkbox"/>	<input type="checkbox"/>
S05	Mission Power Supply System	0	24-Jan-2007	<input type="checkbox"/>	<input type="checkbox"/>