

**GARMIN**®



**G1000**® Integrated Flight Deck  
Pilot's Guide

**Diamond DA40NG**





**SYSTEM OVERVIEW**

**FLIGHT INSTRUMENTS**

**EIS**

**AUDIO PANEL & CNS**

**FLIGHT MANAGEMENT**

**HAZARD AVOIDANCE**

**AFCS**

**ADDITIONAL FEATURES**

**APPENDICES**

**INDEX**

Copyright © 2010-2012 Garmin Ltd. or its subsidiaries. All rights reserved.

This manual reflects the operation of System Software version 0915.04 or later for the Diamond DA40NG. Some differences in operation may be observed when comparing the information in this manual to earlier or later software versions.

Garmin International, Inc., 1200 East 151st Street, Olathe, Kansas 66062, U.S.A.  
Tel: 913/397.8200 Fax: 913/397.8282

Garmin AT, Inc., 2345 Turner Road SE, Salem, OR 97302, U.S.A.  
Tel: 503/391.3411 Fax: 503/364.2138

Garmin (Europe) Ltd., Liberty House, Bulls Copse Road, Hounslow Business Park, Southampton, SO40 9RB, U.K  
Tel: 44/0870.8501241 Fax: 44/0870.8501251

Garmin Corporation, No. 68, Jangshu 2nd Road, Shijr, Taipei County, Taiwan  
Tel: 886/02.2642.9199 Fax: 886/02.2642.9099

For after-hours emergency, aircraft on ground (AOG) technical support for Garmin panel mount and integrated avionics systems, please contact Garmin's AOG Hotline at 913.397.0836.

Website Address: [www.garmin.com](http://www.garmin.com)

Except as expressly provided herein, no part of this manual may be reproduced, copied, transmitted, disseminated, downloaded or stored in any storage medium, for any purpose without the express written permission of Garmin. Garmin hereby grants permission to download a single copy of this manual and of any revision to this manual onto a hard drive or other electronic storage medium to be viewed for personal use, provided that such electronic or printed copy of this manual or revision must contain the complete text of this copyright notice and provided further that any unauthorized commercial distribution of this manual or any revision hereto is strictly prohibited.

Garmin® and G1000® are registered trademarks of Garmin Ltd. or its subsidiaries. FliteCharts®, and SafeTaxi® are trademarks of Garmin Ltd. or its subsidiaries. These trademarks may not be used without the express permission of Garmin.

Honeywell® is a registered trademark of Honeywell International, Inc. Stormscope® is a registered trademark of L-3 Communications. Avidyne® is a registered trademark of Avidyne Corporation. Sirius, XM, and all related marks and logos are trademarks of Sirius XM Radio, Inc. and its subsidiaries.

AOPA Membership Publications, Inc. and its related organizations (hereinafter collectively "AOPA") expressly disclaim all warranties, with respect to the AOPA information included in this data, express or implied, including, but not limited to, the implied warranties of merchantability and fitness for a particular purpose. The information is provided "as is" and AOPA does not warrant or make any representations regarding its accuracy, reliability, or otherwise. Under no circumstances including negligence, shall AOPA be liable for any incidental, special or consequential damages that result from the use or inability to use the software or related documentation, even if AOPA or an AOPA authorized representative has been advised of the possibility of such damages. User agrees not to sue AOPA and, to the maximum extent allowed by law, to release and hold harmless AOPA from any causes of action, claims or losses related to any actual or alleged inaccuracies in the information. Some jurisdictions do not allow the limitation or exclusion of implied warranties or liability for incidental or consequential damages so the above limitations or exclusions may not apply to you.

**LIMITED WARRANTY**

This Garmin product is warranted to be free from defects in materials or workmanship for two years from the date of purchase. Within this period, Garmin will, at its sole option, repair or replace any components that fail in normal use. Such repairs or replacement will be made at no charge to the customer for parts and labor, provided that the customer shall be responsible for any transportation cost. This warranty does not cover failures due to abuse, misuse, accident, or unauthorized alterations or repairs.

THE WARRANTIES AND REMEDIES CONTAINED HEREIN ARE EXCLUSIVE AND IN LIEU OF ALL OTHER WARRANTIES EXPRESS OR IMPLIED OR STATUTORY, INCLUDING ANY LIABILITY ARISING UNDER ANY WARRANTY OF MERCHANTABILITY OR FITNESS FOR A PARTICULAR PURPOSE, STATUTORY OR OTHERWISE. THIS WARRANTY GIVES YOU SPECIFIC LEGAL RIGHTS, WHICH MAY VARY FROM STATE TO STATE.

IN NO EVENT SHALL GARMIN BE LIABLE FOR ANY INCIDENTAL, SPECIAL, INDIRECT OR CONSEQUENTIAL DAMAGES, WHETHER RESULTING FROM THE USE, MISUSE, OR INABILITY TO USE THIS PRODUCT OR FROM DEFECTS IN THE PRODUCT. Some states do not allow the exclusion of incidental or consequential damages, so the above limitations may not apply to you.

Garmin retains the exclusive right to repair or replace the unit or software, or to offer a full refund of the purchase price, at its sole discretion. SUCH REMEDY SHALL BE YOUR SOLE AND EXCLUSIVE REMEDY FOR ANY BREACH OF WARRANTY.

To obtain warranty service, contact your local Garmin Authorized Service Center. For assistance in locating a Service Center near you, visit the Garmin Website at "<http://www.garmin.com>" or contact Garmin Customer Service at 800-800-1020.

Products sold through online auctions are not eligible for warranty coverage or rebates or other special offers from Garmin. Online auction confirmations are not accepted for warranty verification. To obtain warranty service, an original or copy of the sales receipt from the original retailer is required. Garmin will not replace missing components from any package purchased through an online auction.

---

 **WARNING:** Navigation and terrain separation must NOT be predicated upon the use of the terrain avoidance feature. The terrain avoidance feature is NOT intended to be used as a primary reference for terrain avoidance and does not relieve the pilot from the responsibility of being aware of surroundings during flight. The terrain avoidance feature is only to be used as an aid for terrain avoidance. Terrain data is obtained from third party sources. Garmin is not able to independently verify the accuracy of the terrain data.

---

 **WARNING:** The displayed minimum safe altitudes (MSAs) are only advisory in nature and should not be relied upon as the sole source of obstacle and terrain avoidance information. Always refer to current aeronautical charts for appropriate minimum clearance altitudes.

---

 **WARNING:** The altitude calculated by G1000 GPS receivers is geometric height above Mean Sea Level and could vary significantly from the altitude displayed by pressure altimeters, such as the Air Data Computer, or other altimeters in aircraft. GPS altitude should never be used for vertical navigation. Always use pressure altitude displayed by the G1000 PFD or other pressure altimeters in aircraft.

---

 **WARNING:** Do not use outdated database information. Databases used in the G1000 system must be updated regularly in order to ensure that the information remains current. Pilots using any outdated database do so entirely at their own risk.

---

 **WARNING:** Do not use basemap (land and water data) information for primary navigation. Basemap data is intended only to supplement other approved navigation data sources and should be considered as an aid to enhance situational awareness.

---

 **WARNING:** Traffic information shown on the G1000 is provided as an aid in visually acquiring traffic. Pilots must maneuver the aircraft based only upon ATC guidance or positive visual acquisition of conflicting traffic.

---

 **WARNING:** Use of the Stormscope is not intended for hazardous weather penetration (thunderstorm penetration). Stormscope information, as displayed on the G1000, is to be used only for weather avoidance, not penetration.

---

 **WARNING:** Do not use data link weather products (e.g. XM WX Satellite Weather, GFDS Worldwide Weather, or FIS-B) for hazardous weather penetration. Weather information provided by these products is aged by up to several minutes and may not depict actual weather conditions as they currently appear.

---

 **WARNING:** NEXRAD weather data is to be used for long-range planning purposes only. Due to inherent delays in data transmission and the relative age of the data, NEXRAD weather data should not be used for short-range weather avoidance.

---





**WARNING:** The Garmin G1000, as installed in this aircraft, has a very high degree of functional integrity. However, the pilot must recognize that providing monitoring and/or self-test capability for all conceivable system failures is not practical. Although unlikely, it may be possible for erroneous operation to occur without a fault indication shown by the G1000. It is thus the responsibility of the pilot to detect such an occurrence by means of cross-checking with all redundant or correlated information available in the cockpit.



**WARNING:** For safety reasons, G1000 operational procedures must be learned on the ground.



**WARNING:** The United States government operates the Global Positioning System and is solely responsible for its accuracy and maintenance. The GPS system is subject to changes which could affect the accuracy and performance of all GPS equipment. Portions of the Garmin G1000 utilize GPS as a precision electronic NAVigation AID (NAVAID). Therefore, as with all NAVAIDs, information presented by the G1000 can be misused or misinterpreted and, therefore, become unsafe.



**WARNING:** To reduce the risk of unsafe operation, carefully review and understand all aspects of the G1000 Pilot's Guide documentation and the Airplane Flight Manual. Thoroughly practice basic operation prior to actual use. During flight operations, carefully compare indications from the G1000 to all available navigation sources, including the information from other NAVAIDs, visual sightings, charts, etc. For safety purposes, always resolve any discrepancies before continuing navigation.



**WARNING:** The illustrations in this guide are only examples. Never use the G1000 to attempt to penetrate a thunderstorm. Both the FAA Advisory Circular, Subject: Thunderstorms, and the Aeronautical Information Manual (AIM) recommend avoiding "by at least 20 miles any thunderstorm identified as severe or giving an intense radar echo."



**WARNING:** Lamp(s) inside this product may contain mercury (HG) and must be recycled or disposed of according to local, state, or federal laws. For more information, refer to our website at [www.garmin.com/aboutGarmin/environment/disposal.jsp](http://www.garmin.com/aboutGarmin/environment/disposal.jsp).



**WARNING:** Because of variation in the earth's magnetic field, operating the G1000 within the following areas could result in loss of reliable attitude and heading indications. North of 72° North latitude at all longitudes; South of 70° South latitude at all longitudes; North of 65° North latitude between longitude 75° W and 120° W. (Northern Canada); North of 70° North latitude between longitude 70° W and 128° W. (Northern Canada); North of 70° North latitude between longitude 85° E and 114° E. (Northern Russia); South of 55° South latitude between longitude 120° E and 165° E. (Region south of Australia and New Zealand)



**WARNING:** Do not use GPS to navigate to any active waypoint identified as a 'NON WGS84 WPT' by a system message. 'NON WGS84 WPT' waypoints are derived from an unknown map reference datum that may be incompatible with the map reference datum used by GPS (known as WGS84) and may be positioned in error as displayed.



**CAUTION:** The PFD and MFD displays use a lens coated with a special anti-reflective coating that is very sensitive to skin oils, waxes, and abrasive cleaners. **CLEANERS CONTAINING AMMONIA WILL HARM THE ANTI-REFLECTIVE COATING.** It is very important to clean the lens using a clean, lint-free cloth and an eyeglass lens cleaner that is specified as safe for anti-reflective coatings.



**CAUTION:** The Garmin G1000 does not contain any user-serviceable parts. Repairs should only be made by an authorized Garmin service center. Unauthorized repairs or modifications could void both the warranty and the pilot's authority to operate this device under FAA/FCC regulations.



**NOTE:** When using Stormscope, there are several atmospheric phenomena in addition to nearby thunderstorms that can cause isolated discharge points in the strike display mode. However, clusters of two or more discharge points in the strike display mode do indicate thunderstorm activity if these points reappear after the screen has been cleared.



**NOTE:** All visual depictions contained within this document, including screen images of the G1000 panel and displays, are subject to change and may not reflect the most current G1000 system. Depictions of equipment may differ slightly from the actual equipment.



**NOTE:** This device complies with part 15 of the FCC Rules. Operation is subject to the following two conditions: (1) this device may not cause harmful interference, and (2) this device must accept any interference received, including interference that may cause undesired operation.



**NOTE:** Interference from GPS repeaters operating inside nearby hangars can cause an intermittent loss of attitude and heading displays while the aircraft is on the ground. Moving the aircraft more than 100 feet away from the source of the interference should alleviate the condition.



**NOTE:** Use of polarized eyewear may cause the flight displays to appear dim or blank.



**NOTE:** This product, its packaging, and its components contain chemicals known to the State of California to cause cancer, birth defects, or reproductive harm. This notice is being provided in accordance with California's Proposition 65. If you have any questions or would like additional information, please refer to our web site at [www.garmin.com/prop65](http://www.garmin.com/prop65).

Record of Revisions				
Part Number	Revision	Date	Page Range	Description
190-00952-00	A	3/4/10	All	Initial release
190-00952-01	A	3/31/11	All	Changed Oil Pressure warning annunciation description. Changed system software number from 0915.01 to 0915.03
190-00952-02	A	1/13/12	All	Added GDU 11.12 parameters

**SECTION 1 SYSTEM OVERVIEW**

- 1.1 Line Replaceable Units** ..... 2
- 1.2 Secure Digital (SD) Cards** ..... 7
- 1.3 System Power-up** ..... 8
- 1.4 System Operation**..... 9
  - Display Operation ..... 9
  - G1000 System Annunciations ..... 10
  - System Status..... 11
  - AHRS Operation ..... 13
  - GPS Receiver Operation ..... 14
- 1.5 G1000 Controls**..... 18
  - PFD/MFD Controls ..... 18
  - Softkey Function ..... 20
- 1.6 Accessing G1000 Functionality**..... 27
  - Menus ..... 27
  - Data Entry..... 27
  - Page Groups ..... 29
  - System Settings ..... 33
  - Timers ..... 39
- 1.7 Display Backlighting** ..... 42

**SECTION 2 FLIGHT INSTRUMENTS**

- 2.1 Flight Instruments** ..... 46
  - Airspeed Indicator ..... 46
  - Attitude Indicator ..... 48
  - Altimeter ..... 49
  - Vertical Speed Indicator (VSI)..... 51
  - Vertical Deviation ..... 52
  - Horizontal Situation Indicator (HSI) ..... 53
  - Course Deviation Indicator (CDI) ..... 58
- 2.2 Supplemental Flight Data** ..... 65
  - Outside Air Temperature ..... 65
  - Wind Data ..... 67
  - Vertical Navigation (VNV) Indications ..... 68
- 2.3 PFD Annunciations and Alerting Functions** ..... 69
  - System Alerting ..... 69
  - Marker Beacon Annunciations..... 70
  - Traffic Annunciation ..... 70
  - Terrain Annunciations ..... 71
  - Altitude Alerting ..... 72
  - Low Altitude Annunciation ..... 72
  - Minimum Descent Altitude/Decision Height Alerting ..... 73
- 2.4 Abnormal Operations** ..... 74
  - Abnormal GPS Conditions ..... 74

- Unusual Attitudes ..... 75

**SECTION 3 ENGINE INDICATION SYSTEM**

- 3.1 Engine Display** ..... 78
- 3.2 System Display** ..... 80
- 3.3 Fuel Display**..... 82
- 3.4 EIS Display In Reversionary Mode** ..... 84

**SECTION 4 AUDIO PANEL AND CNS**

- 4.1 Overview** ..... 87
  - MFD/PFD Controls and Frequency Display ..... 88
  - Audio Panel Controls ..... 90
- 4.2 COM Operation**..... 92
  - COM Transceiver Selection and Activation ..... 92
  - COM Transceiver Manual Tuning ..... 93
  - Quick-Tuning and Activating 121.500 MHz ..... 94
  - Auto-Tuning the COM Frequency ..... 95
  - Frequency Spacing ..... 99
  - Automatic Squelch ..... 100
  - Volume ..... 100
- 4.3 NAV Operation**..... 101
  - NAV Radio Selection and Activation ..... 101
  - NAV Receiver Manual Tuning ..... 102
  - Auto-Tuning a NAV Frequency from the MFD..... 104
  - Marker Beacon Receiver ..... 109
  - ADF/DME Tuning ..... 110
- 4.4 GTX 33 Mode S Transponder**..... 114
  - Transponder Controls ..... 114
  - Transponder Mode Selection..... 115
  - Entering a Transponder Code ..... 117
  - IDENT Function ..... 118
- 4.5 Additional Audio Panel Functions** ..... 119
  - Power-Up..... 119
  - Mono/Stereo Headsets ..... 119
  - Speaker ..... 119
  - Intercom ..... 120
  - Clearance Recorder and Player..... 122
  - Split COM ..... 123
- 4.6 Audio Panel Preflight Procedure** ..... 125
- 4.7 Abnormal Operation** ..... 126
  - Stuck Microphone..... 126
  - COM Tuning Failure..... 126
  - Audio Panel Fail-Safe Operation ..... 126
  - Reversionary Mode ..... 126



<b>SECTION 5 FLIGHT MANAGEMENT</b>	
<b>5.1 Introduction</b> .....	127
Navigation Status Box .....	128
<b>5.2 Using Map Displays</b> .....	130
Map Orientation .....	130
Map Range .....	132
Map Panning .....	134
Measuring Bearing and Distance .....	139
Topography .....	140
Map Symbols .....	143
Airways .....	149
Track Vector .....	151
Wind Vector .....	152
Nav Range Ring .....	153
Fuel Range Ring .....	154
Field of View (SVS) .....	155
Selected Altitude Intercept Arc .....	156
<b>5.3 Waypoints</b> .....	157
Airports .....	158
Intersections .....	165
NDBs .....	167
VORs .....	169
User Waypoints .....	171
<b>5.4 Airspaces</b> .....	177
<b>5.5 Direct-to-Navigation</b> .....	181
<b>5.6 Flight Planning</b> .....	187
Flight Plan Creation .....	188
Adding Waypoints to an Existing Flight Plan .....	193
Adding Airways to a Flight Plan .....	195
Adding Procedures to a Stored Flight Plan .....	197
Flight Plan Storage .....	204
Flight Plan Editing .....	206
Along Track Offsets .....	209
Parallel Track .....	211
Activating a Flight Plan Leg .....	214
Inverting a Flight Plan .....	215
Flight Plan Views .....	216
Closest Point of FPL .....	218
<b>5.7 Vertical Navigation</b> .....	219
Altitude Constraints .....	221
<b>5.8 Procedures</b> .....	225
Departures .....	225
Arrivals .....	228
Approaches .....	230
<b>5.9 Trip Planning</b> .....	236
Trip Planning .....	236
<b>5.10 RAIM Prediction</b> .....	240
<b>5.11 Navigating a Flight Plan</b> .....	243
<b>5.12 Abnormal Operation</b> .....	271
<b>SECTION 6 HAZARD AVOIDANCE</b>	
<b>6.1 XM WX Satellite Weather</b> .....	274
Activating Services .....	274
Using XM WX Satellite Weather Products .....	275
<b>6.2 WX-500 Stormscope</b> .....	308
Setting Up Stormscope on the Navigation Map .....	308
Selecting the Stormscope Page .....	312
<b>6.3 Terrain Proximity</b> .....	313
Displaying Terrain Proximity Data .....	313
Terrain Proximity Page .....	316
<b>6.4 Profile View Terrain</b> .....	318
Profile View Display .....	319
<b>6.5 Terrain-SVS</b> .....	322
Displaying Terrain-SVS Data .....	323
Terrain-SVS Page .....	325
Terrain-SVS Alerts .....	327
System Status .....	330
<b>6.6 Traffic Information Service (TIS)</b> .....	331
Displaying TRAFFIC Data .....	332
Traffic Map Page .....	334
TIS Alerts .....	335
System Status .....	337
<b>6.7 Avidyne TAS600 Traffic</b> .....	339
TAS Symbolology .....	339
Displaying Traffic Data .....	340
Altitude Display .....	341
Traffic Map Page Display Range .....	342
TAS Alerts .....	343
System Status .....	344
<b>SECTION 7 AUTOMATIC FLIGHT CONTROL SYSTEM (OPTIONAL)</b>	
<b>7.1 AFCS Controls</b> .....	348
<b>7.2 Flight Director Operation</b> .....	350
Activating the Flight Director .....	350
AFCS Status Box .....	351
Command Bars .....	352

Flight Director Modes..... 352

**7.3 Vertical Modes** ..... 353

    Pitch Hold Mode (PIT) ..... 354

    Selected Altitude Capture Mode (ALTS) ..... 355

    Altitude Hold Mode (ALT) ..... 356

    Vertical Speed Mode (VS) ..... 357

    Flight Level Change Mode (FLC) ..... 358

    Vertical Navigation Modes (VPTH, ALTV) ..... 360

    Glidepath Mode (GP) (SBAS only)..... 365

    Glideslope Mode (GS) ..... 367

    Go Around Mode (GA) ..... 368

**7.4 Lateral Modes** ..... 369

    Roll Hold Mode (ROL) ..... 370

    Heading Select Mode (HDG) ..... 371

    Navigation Modes (GPS, VOR, LOC, BC) ..... 372

    Approach Modes (GPS, VAPP, LOC) ..... 374

**7.5 Autopilot Operation**..... 376

    Engaging the Autopilot ..... 376

    Control Wheel Steering ..... 377

    Disengaging the Autopilot..... 377

**7.6 Example Flight Plan** ..... 378

    Departure ..... 379

    Intercepting a VOR Radial..... 381

    Flying a Flight Plan/GPS Course ..... 382

    Descent ..... 383

    Approach..... 387

    Go Around/Missed Approach ..... 389

**7.7 AFCS Annunciations and Alerts** ..... 391

    AFCS Status Alerts ..... 391

    Overspeed Protection..... 392

    Annunciations for KAP 140 Autopilot System ..... 392

**SECTION 8 ADDITIONAL FEATURES**

**8.1 Synthetic Vision System (SVS) (Optional)**..... 394

    SVS Operation ..... 395

    SVS Features ..... 397

    Field of View ..... 405

**8.2 SafeTaxi** ..... 407

**8.3 ChartView**..... 412

    ChartView Softkeys..... 412

    Terminal Procedures Charts ..... 413

    Chart Options..... 421

    Day/Night View ..... 427

ChartView Cycle Number and Expiration Date ..... 429

**8.4 FliteCharts** ..... 432

    FliteCharts Softkeys ..... 432

    Terminal Procedures Charts ..... 433

    Chart Options..... 440

    Day/Night View ..... 444

    FliteCharts Cycle Number and Expiration Date..... 446

**8.5 AOPA Airport Directory**..... 449

    AOPA Database Cycle Number and Revision ..... 450

**8.6 SiriusXM Satellite Radio (Optional)** ..... 452

    Activating SiriusXM Satellite Radio Services ..... 452

    Using SiriusXM Satellite Radio ..... 454

**8.7 Scheduler**..... 457

**8.8 Electronic Checklists (Optional)** ..... 459

**8.9 Flight Data Logging** ..... 462

**8.10 Auxiliary Video (Optional)** ..... 464

    Video Setup ..... 465

    Display Selection ..... 465

    Zoom/Range ..... 466

**8.11 Abnormal Operation** ..... 467

    SVS Troubleshooting ..... 467

    Reversionary Mode..... 467

    Unusual Attitudes ..... 468

**APPENDICES**

**Annunciations and Alerts** ..... 471

    TERRAIN-SVS Alerts ..... 489

    TERRAIN-SVS Status Annunciations ..... 489

**Database Management** ..... 490

    Jeppesen Databases..... 490

    Garmin Databases ..... 492

**Glossary**..... 499

**Frequently Asked Questions** ..... 505

**General TIS Information** ..... 509

**Map Symbols** ..... 511

**INDEX**

Index ..... |-1

## SECTION 1 SYSTEM OVERVIEW



**NOTE:** Refer to the *Automatic Flight Control System (AFCS)* Section for details on the *GFC 700 AFCS*.

The G1000 Integrated Flight Deck System presents flight instrumentation, position, navigation, communication, and identification information using flat-panel color displays. The system is distributed across the following Line Replaceable Units (LRUs):

- **GDU 1040** Primary Flight Display (PFD)
- **GDU 1040/1044** Multi Function Display (MFD)
- **GMA 1347** Audio Panel with Integrated Marker Beacon Receiver
- **GIA 63/63W** Integrated Avionics Units (IAU)
- **GDC 74A** Air Data Computer (ADC)
- **GEA 71** Engine/Airframe Unit
- **GTX 33** Mode S Transponder
- **GRS 77** Attitude and Heading Reference System (AHRS)
- **GMU 44** Magnetometer
- **GDL 69/69A** Data Link Receiver
- **GSA 81** AFCS Servos
- **GSM 85 (or GSM 86)** Servo Mounts

Figure 1-1 shows interactions between the LRUs. Additional/optional equipment are shown in Figure 1-2.

The Diamond DA40NG may be optionally equipped with a GFC 700 Automated Flight Control System (AFCS), providing flight director (FD), autopilot (AP), and manual electric trim (MET) functions of the G1000 System.

## 1.1 LINE REPLACEABLE UNITS

- **GDU 1040/1044** (2) – A GDU 1040 is configured as the Primary Flight Display (PFD) and a GDU 1040 or 1044 (1044 for airframes equipped with the GFC 700) as a Multi Function Display (MFD). Both displays feature 10.4-inch LCD screens with 1024 x 768 resolution. The displays communicate with each other through a High-speed Data Bus (HSDB) Ethernet connection. Each display is also paired with an Ethernet connection to an IAU. The three GDU models are distinguished by three individual configurations of bezel controls and are made available to accommodate a variety optional system installations.



- **GMA 1347** – The Audio Panel integrates navigation/communication radio (NAV/COM) digital audio, intercom, and marker beacon controls, and is installed between the displays. This unit also provides manual control of display Reversionary Mode (red **DISPLAY BACKUP** button; see Section 1.4, System Operation) and communicates with both IAUs using an RS-232 digital interface.



- **GIA 63/63W** (2) – The Integrated Avionics Units (IAU) function as the main communications hub, linking all LRUs with the PFD. Each IAU contains a GPS receiver, a very high frequency (VHF) communication/navigation/glideslope (COM/NAV/GS) receiver, and system integration microprocessors, and is paired with the on-side display via an HSDB connection. The GIA 63W contains a GPS SBAS receiver. The IAUs are not paired together and do not communicate with each other directly.





**GDC 74A** – The Air Data Computer (ADC) processes data from the pitot/static system and outside air temperature (OAT) sensor. The ADC provides pressure altitude, airspeed, vertical speed, and OAT information to the G1000 System, and it communicates with the primary IAU, displays, and AHRS using an ARINC 429 digital interface.



- **GEA 71** – The Engine Airframe Unit receives and processes signals from the engine and airframe sensors. This unit communicates with both IAUs using an RS-485 digital interface.



- **GTX 33** – The solid-state Transponder provides Modes A, C, and S capability and communicates with both IAUs through an RS-232 digital interface.



- **GRS 77** – The Attitude and Heading Reference System (AHRS) provides aircraft attitude and heading information via ARINC 429 to both the PFD and the primary IAU. The AHRS contains advanced sensors (including accelerometers and rate sensors) and interfaces with the Magnetometer to obtain magnetic field information, with the ADC to obtain air data, and with both IAUs to obtain GPS information. AHRS operation is discussed in Section 1.4, System Operation.



- **GMU 44** – The Magnetometer measures local magnetic field and sends data to the AHRS for processing to determine aircraft magnetic heading. This unit receives power directly from the AHRS and communicates with it via an RS-485 digital interface.



- **GDL 69/69A** – The Data Link Satellite Radio Receiver provides real-time weather information to MFD maps and the PFD Inset Map. The GDL 69A model is also capable of providing digital audio entertainment. The Data Link Receiver communicates with the MFD via an HSDB connection. A subscription to XM Satellite Radio Service is required to enable Data Link Receiver capability.



- **GSA 81** and **GSM 85 (or GSM 86)** – The GSA 81 servos are used for automatic control of pitch, pitch trim, and roll. These units interface with each IAU.

The GSM 85 (or GSM 86) servo mounts are responsible for transferring the output torque of the servo actuators to the mechanical flight-control surface linkages.



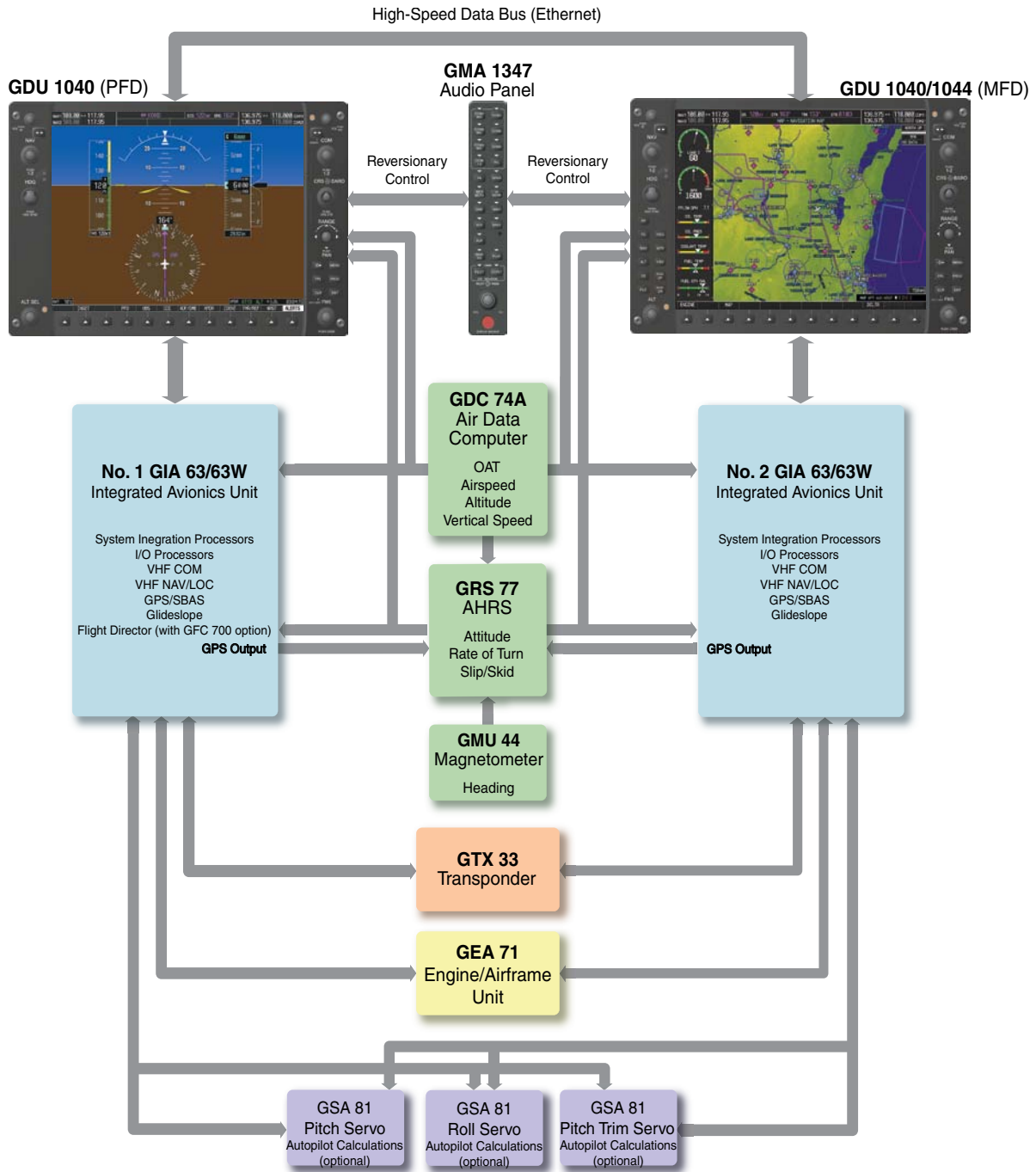

Figure 1-1 G1000 System Block Diagram



**NOTE:** The GDU 1044 is equipped with additional bezel controls and is available for use in systems equipped with the Garmin GFC 700 Automatic Flight Control System.

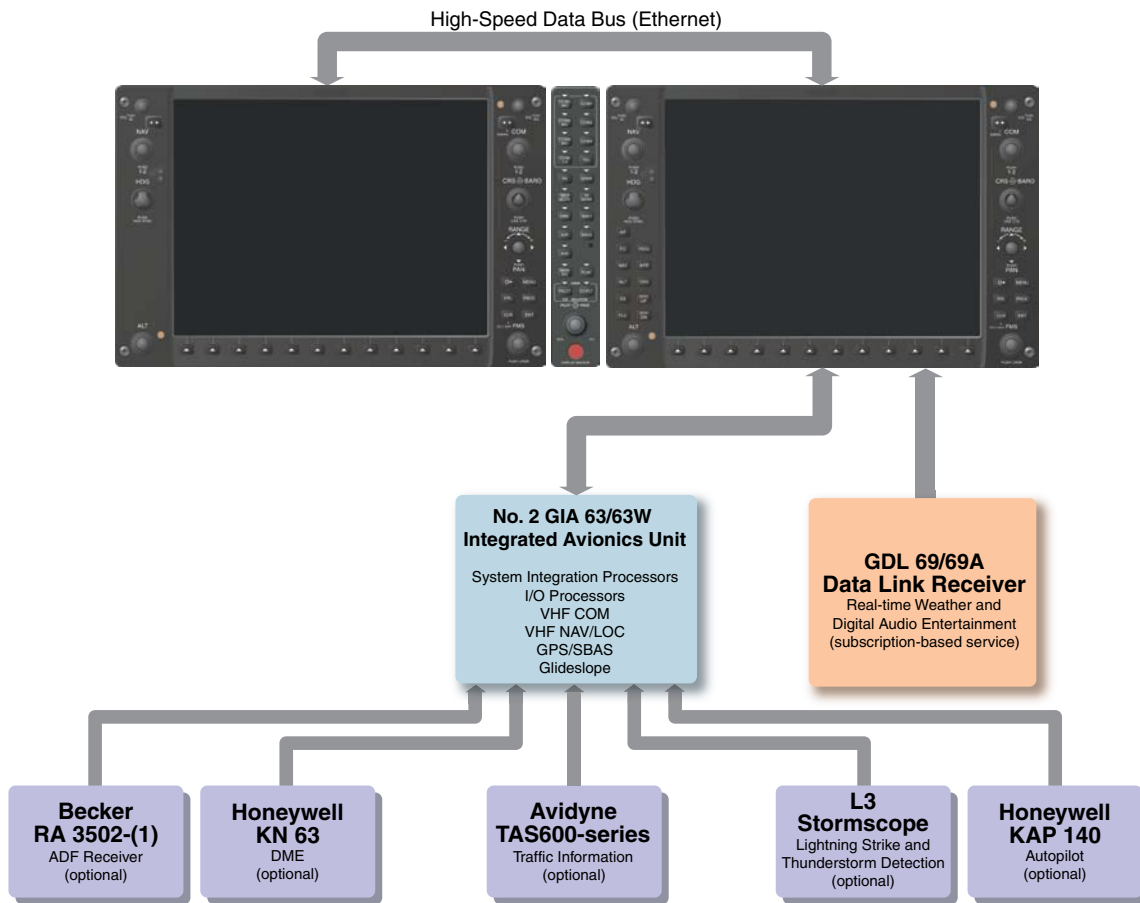

Figure 1-2 G1000 With Optional/Additional Interfaces



**NOTE:** The GDU 1040 is available in systems using the Honeywell KAP 140 Autopilot.



**NOTE:** For information on additional equipment shown in Figure 1-2, consult the applicable optional interface user's guide. This document assumes that the reader is already familiar with the operation of this additional equipment.



## 1.2 SECURE DIGITAL (SD) CARDS



**NOTE:** Ensure the G1000 System is powered off before inserting an SD card.



**NOTE:** Refer to Appendix B for instructions on updating databases.

The PFD and MFD data card slots use Secure Digital (SD) cards and are located on the upper right side of the display bezels. Each display bezel is equipped with two SD card slots. SD cards are used for aviation database and system software updates as well as terrain database storage.

### Installing an SD card:

- 1) Insert the SD card in the SD card slot, pushing the card in until the spring latch engages. The front of the card should remain flush with the face of the display bezel.
- 2) To eject the card, gently press on the SD card to release the spring latch.



Figure 1-3 Display Bezel SD Card Slots

### 1.3 SYSTEM POWER-UP

**NOTE:** See the Aircraft Flight Manual (AFM) for specific procedures concerning avionics power application and emergency power supply operation.

**NOTE:** Refer to Appendix A for system-specific annunciations and alerts.

The G1000 System is integrated with the aircraft electrical system and receives power directly from electrical busses. The PFD, MFD, and supporting sub-systems include both power-on and continuous built-in test features that exercise the processor, RAM, ROM, external inputs, and outputs to provide safe operation.

During system initialization, test annunciations are displayed, as shown in Figure 1-4. All system annunciations should disappear typically within the first minute of power-up. Upon power-up, key annunciator lights also become momentarily illuminated on the Audio Panel and the display bezels.

On the PFD, the AHRS begins to initialize and displays “AHRS ALIGN: Keep Wings Level”. The AHRS should display valid attitude and heading fields typically within the first minute of power-up. The AHRS can align itself both while taxiing and during level flight.

When the MFD powers up, the splash screen (Figure 1-5) displays the following information:

- System version
- Copyright
- Land database name and version
- Obstacle database name and version
- Terrain database name and version
- Aviation database name, version, and effective dates

Current database information includes valid operating dates, cycle number, and database type. When this information has been reviewed for currency (to ensure that no databases have expired), the pilot is prompted to continue.

Pressing the **ENT** Key (or right-most softkey) acknowledges this information, and the Navigation Map Page is displayed upon pressing the key a second time. When the system has acquired a sufficient number of satellites to determine a position, the aircraft's current position is shown on the Navigation Map Page.



Figure 1-4 PFD Initialization

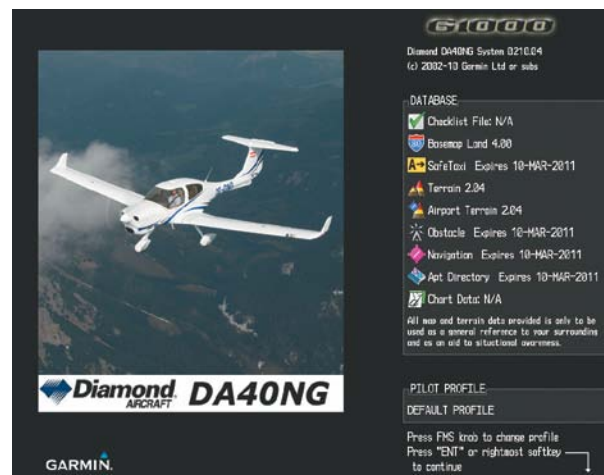

Figure 1-5 Example (DA40NG) MFD Power-up Splash Screen

## 1.4 SYSTEM OPERATION

**NOTE:** Refer to Appendix A for detailed descriptions of all alerts and annunciations. Refer to the Airplane Flight Manual (AFM) for additional information regarding pilot responses to these annunciations.

The displays are connected together via a single Ethernet bus for high-speed communication. As shown in Figure 1-1, each IAU is connected to the on-side display. This allows the units to share information, enabling true system integration

### DISPLAY OPERATION

**NOTE:** In normal operating mode, backlighting can only be adjusted from the PFD. In Reversionary Mode, it can be adjusted from the remaining display.

In normal operating mode, the PFD presents graphical flight instrumentation (attitude, heading, airspeed, altitude, vertical speed), replacing the traditional flight instrument cluster (see the Flight Instruments Section for more information). The MFD normally displays a full-color moving map with navigation information (see the Flight Management Section), while the left portion of the MFD is dedicated to the Engine Indication System (EIS; see the EIS Section). Both displays offer control for COM and NAV frequency selection.



Figure 1-6 G1000 Normal Operation

In the event of a display failure, the G1000 System automatically switches to reversionary (backup) mode. In Reversionary Mode, all important flight information from the PFD is presented on the remaining display in the same format as in normal operating mode, with the addition of the EIS. EIS operation while in Reversionary Mode is discussed in the EIS Section. As when the PFD is operating normally, windows for flight planning, nearest airports, and procedures are available. The Inset Map is moved to the right side of the display.

If a display fails, the appropriate IAU-display Ethernet interface is cut off. Thus, the IAU can no longer communicate with the remaining display (refer to Figure 1-1), and the NAV and COM functions provided to the failed display by the IAU are flagged as invalid on the remaining display. The system reverts to backup paths for the AHRS, ADC, Engine/Airframe Unit, and Transponder, as required. The change to backup paths is completely automated for all LRUs and no pilot action is required.

If the system fails to detect a display problem, Reversionary Mode may be manually activated by pressing the Audio Panel's red **DISPLAY BACKUP** Button. Pressing this button again deactivates Reversionary Mode.

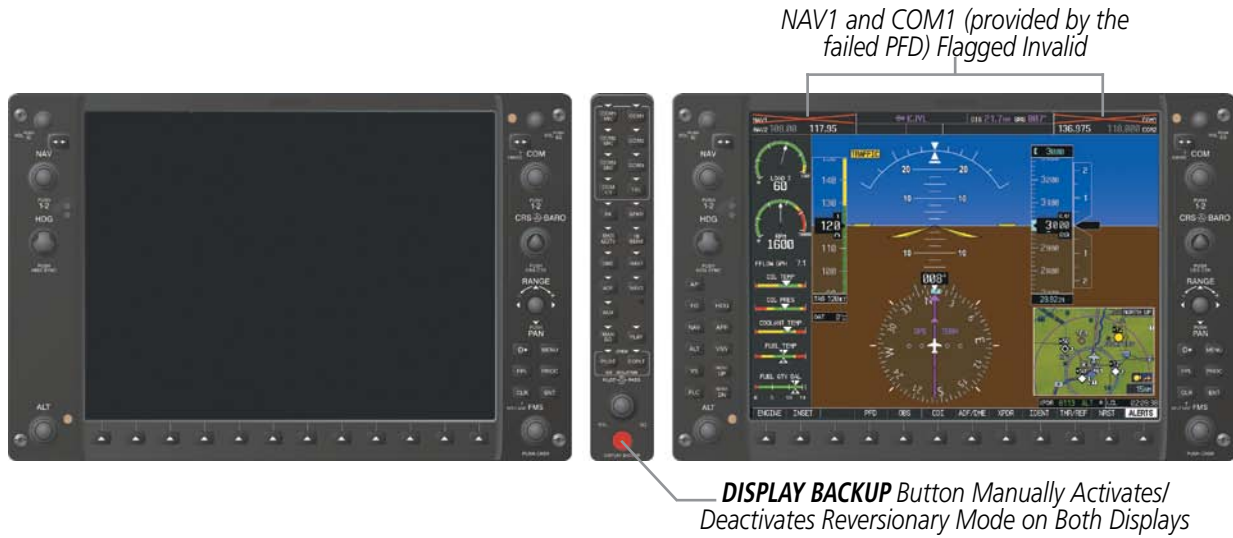

Figure 1-7 G1000 Reversionary Mode (Failed PFD)

## G1000 SYSTEM ANNUNCIATIONS

When an LRU or an LRU function fails, a large red 'X' is typically displayed over the instrument experiencing failed data (Figure 1-8 displays all possible flags and responsible LRUs). The G1000 System alerts the pilot when backup paths are utilized by the LRUs. Upon G1000 power-up, certain instruments remain invalid as equipment begins to initialize. All instruments should be operational within one minute of power-up. If any instrument remains flagged, the G1000 should be serviced by a Garmin-authorized repair facility.

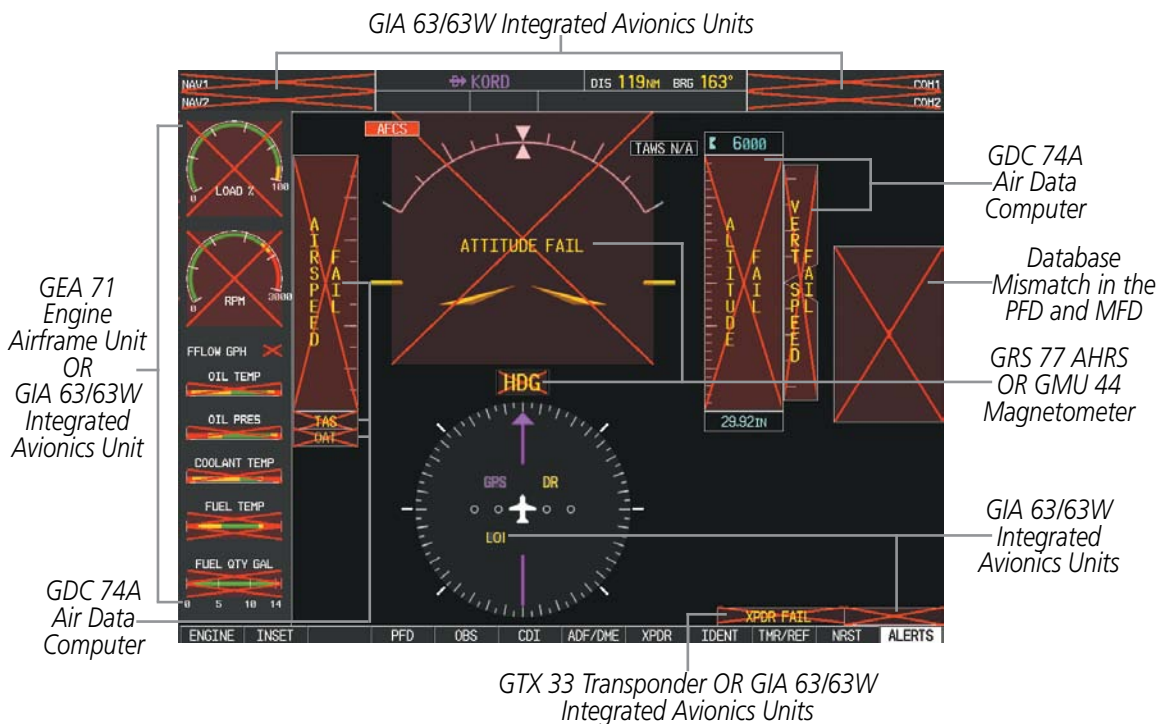

Figure 1-8 G1000 System Failure Annunciations

## SYSTEM STATUS

The System Status Page displays the statuses, serial numbers, and software version numbers for all detected system LRUs. Active LRUs are indicated by green check marks; failed, by red 'X's. Failed LRUs should be noted and a service center or Garmin-authorized dealer informed.

### Viewing LRU information:

- 1) Use the **FMS** Knob to select the AUX - System Status Page.
- 2) To place the cursor in the 'LRU Info' Box,
  - a) Press the **LRU** Softkey.
  - Or:
    - a) Press the **MENU** Key.
    - b) With 'Select LRU Window' highlighted, press the **ENT** Key.
- 3) Use the **FMS** Knob to scroll through the box to view LRU status information.

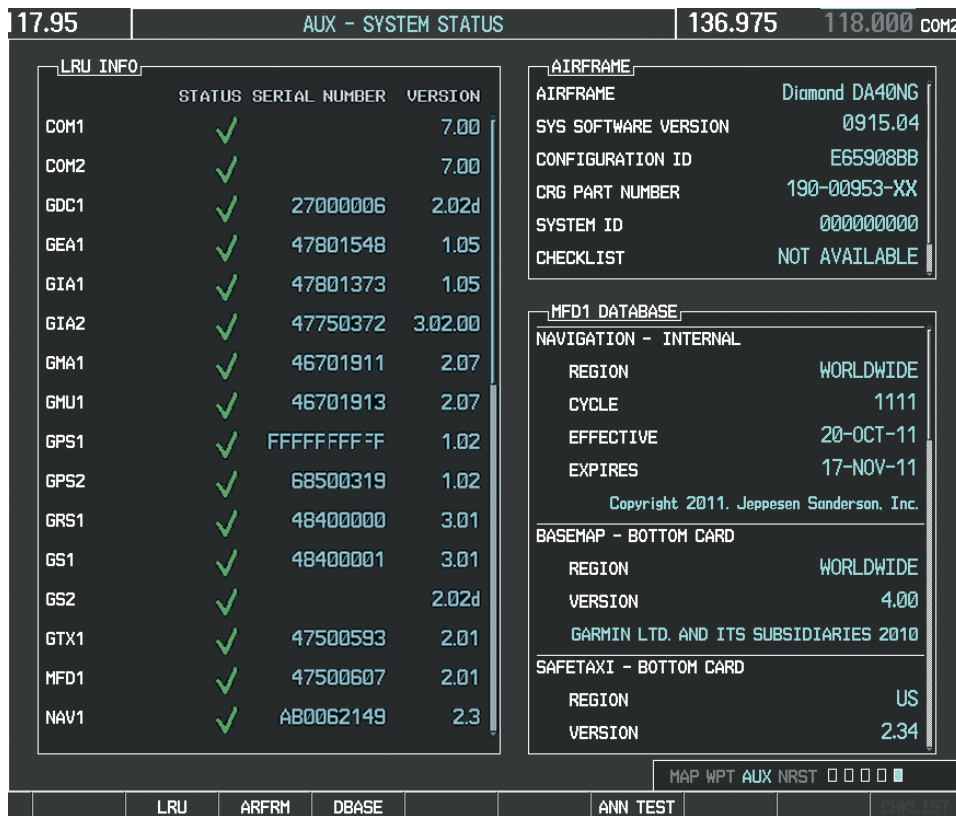

Figure 1-9 Example System Status Page



Pertinent information on all system databases is also displayed on this page. Refer to the Appendices and Additional Features sections for more information about databases.

**Viewing database information:**

- 1) Use the **FMS** Knob to select the AUX - System Status Page.
- 2) To place the cursor in the 'Database' Box,
  - a) Press the **DBASE** Softkey.

**Or:**

  - a) Press the **MENU** Key.
  - b) Highlight 'Select Dbase Window' and press the **ENT** Key.
- 3) Use the **FMS** Knob to scroll through the box to view database status information.

The G1000 uses aural tones to convey the priority of airframe-specific alerts. The alerting system's annunciation tone may be tested from the System Status Page. Refer to the Appendices for airframe-specific alerts.

**Testing the system annunciation tone:**

- 1) Use the **FMS** Knob to select the AUX - System Status Page.
- 2) Press the **ANN TEST** Softkey.

**Or:**

  - a) Press the **MENU** Key.
  - b) Highlight 'Enable Annunciator Test Mode' and press the **ENT** Key.

AHRS OPERATION

**NOTE:** Aggressive maneuvering while AHRS is not operating normally may degrade AHRS accuracy.

In addition to using internal sensors, the GRS 77 AHRS uses GPS information, magnetic field data and air data to assist in attitude/heading calculations. In normal mode, the AHRS relies upon GPS and magnetic field measurements. If either of these external measurements is unavailable or invalid, the AHRS uses air data information for attitude determination. Four AHRS modes of operation are available (see Figure 1-10) and depend upon the combination of available sensor inputs. Loss of air data, GPS, or magnetometer sensor inputs is communicated to the pilot by message advisory alerts.

The AHRS (GRS 77) corrects for shifts and variations in the Earth’s magnetic field by applying the Magnetic Field Variation Database. The Magnetic Field Variation Database is derived from the International Geomagnetic Reference Field (IGRF). The IGRF is a mathematical model that describes the Earth’s main magnetic field and its annual rate of change. The database is updated approximately every 5 years. See the Appendices for information on updating the Magnetic Field Variation Database. The system will prompt you on startup when an update is available. Failure to update this database could lead to erroneous heading information being displayed to the pilot.

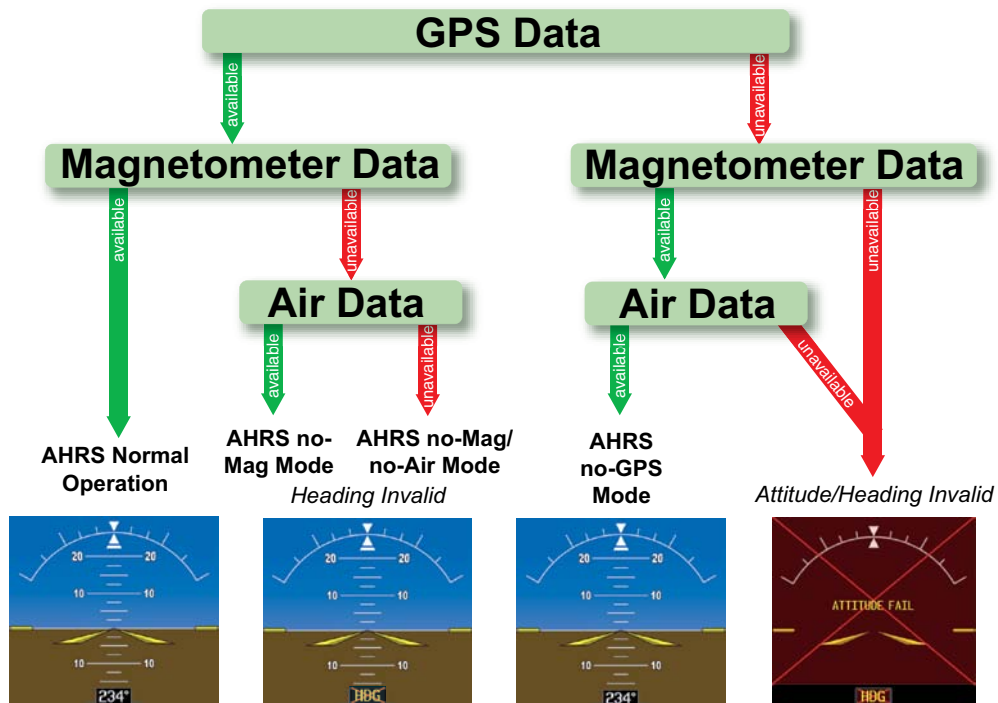

Figure 1-10 AHRS Operation

## GPS RECEIVER OPERATION

Each Integrated Avionics Unit (IAU) contains a GPS receiver. Internal system checking is performed to ensure both GPS receivers are providing accurate data to the PFD. When both GPS receivers are providing accurate data, the GPS receiver producing the better solution is used by the system. Information collected by the specified receiver (GPS1 for the #1 IAU or GPS2 for the #2 IAU) may be viewed on the AUX - GPS Status Page.

### Viewing GPS receiver status information:

- 1) Use the large **FMS** Knob on the MFD to select the Auxiliary Page Group (see Section 1.6 for information on navigating MFD page groups).
- 2) Use the small **FMS** Knob to select GPS Status Page (third page in the AUX Page Group).
- 3) To change the selected GPS receiver:
  - Press the desired **GPS** Softkey.
  - Or:**
    - a) Press the **MENU** Key.
    - b) Use the **FMS** Knob to highlight the receiver which is not selected and press the **ENT** Key.

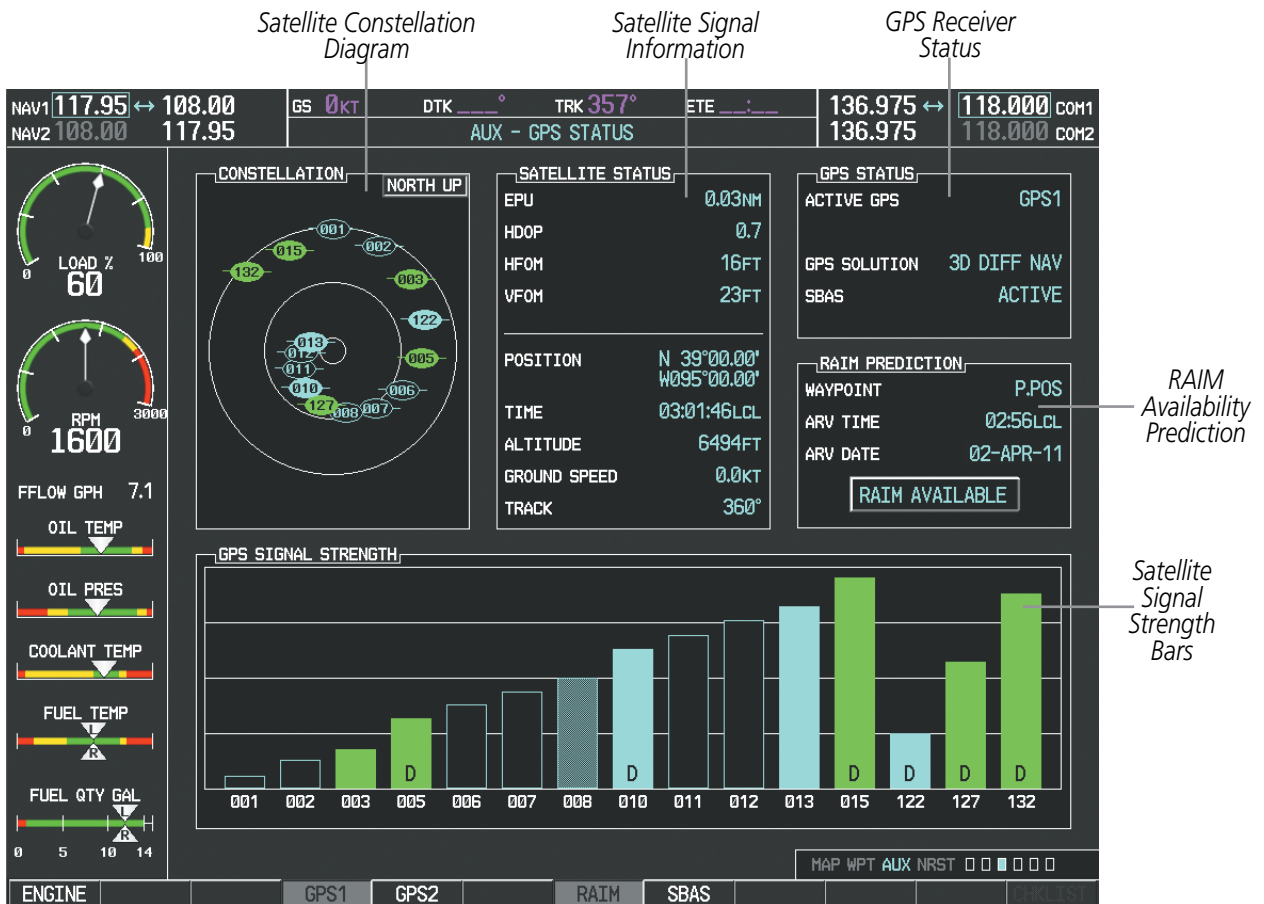

Figure 1-11 GPS Status Page



For SBAS-enabled systems, GPS sensor annunciations are most often seen after system power-up when one GPS receiver has acquired satellites before the other or one of the GPS receivers has not yet acquired a SBAS signal. While the aircraft is on the ground, the SBAS signal may be blocked by obstructions causing one GPS receiver to have difficulty acquiring a good signal. Also, while airborne, turning the aircraft may result in one of the GPS receivers temporarily losing the SBAS signal. If no failure message exists, check the GPS Status Page and compare the information for GPS1 and GPS2. Discrepancies may indicate a problem.

## GPS RECEIVER STATUS

The GPS solution type (ACQUIRING, 2D NAV, 2D DIFF NAV, 3D NAV, 3D DIFF NAV) for the active GPS receiver (GPS1 or GPS2) is shown in the upper right of the GPS Status Page. When the receiver is in the process of acquiring enough satellite signals for navigation, the receiver uses satellite orbital data (collected continuously from the satellites) and last known position to determine the satellites that should be in view. ACQUIRING is indicated as the solution until a sufficient number of satellites have been acquired for computing a solution.

When the receiver is in the process of acquiring a 3D navigational GPS solution, 3D NAV is indicated as the solution until the 3D differential fix has finished acquisition. Satellite-Based Augmentation System (SBAS) status should be indicated as INACTIVE at this point. When acquisition is complete, the solution status changes to 3D DIFF NAV and SBAS becomes active.

In certain situations, such as when the aircraft is outside or on the fringe of the EGNOS, MSAS (used only in Japan), or WAAS coverage area, it may be desirable to disable EGNOS, MSAS, or WAAS (although it is not recommended). When disabled, the SBAS field in the GPS Status box indicates DISABLED. There may be a small delay for the GPS Status box to be updated upon EGNOS, MSAS, or WAAS enabling/disabling.

### Disabling EGNOS, MSAS, or WAAS

- 1) Select the GPS Status Page.
- 2) If necessary, press the **SBAS** Softkey.
- 3) Press the **FMS** Knob, and turn the large FMS Knob to highlight 'EGNOS', 'MSAS', or 'WAAS'.
- 4) Press the **ENT** Key to uncheck the box.
- 5) Press the **FMS** Knob to remove the cursor.

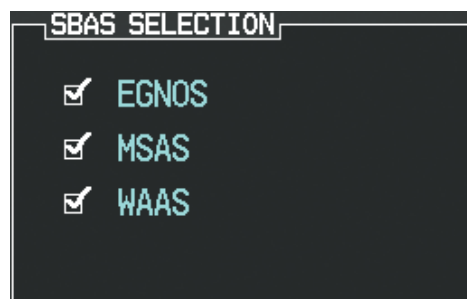

Figure 1-12 Enable/Disable SBAS

## RAIM PREDICTION

Receiver Autonomous Integrity Monitoring (RAIM) is a GPS receiver function that performs a consistency check on all tracked satellites. RAIM ensures that the available satellite geometry allows the receiver to calculate a position within a specified RAIM protection limit (2.0 nautical miles for oceanic and enroute, 1.0 nm for terminal, and 0.3 nm for non-precision approaches). During oceanic, enroute, and terminal phases of flight, RAIM is available nearly 100% of the time.

The RAIM prediction function also indicates whether RAIM is available at a specified date and time. RAIM computations predict satellite coverage within  $\pm 15$  min of the specified arrival date and time. In G1000 systems with SBAS enabled, performing RAIM prediction is not necessary in most cases. However, if the selected approach is outside the SBAS coverage area, it may be necessary to perform a RAIM prediction for the intended approach.

Because of the tighter protection limit on approaches, there may be times when RAIM is not available. The G1000 automatically monitors RAIM and warns with an alert message when it is not available. If RAIM is not predicted to be available for the final approach course, the approach does not become active, as indicated by the messages “Approach is not active”. If RAIM is not available when crossing the FAF, the missed approach procedure must be flown.

### Predicting RAIM availability:

- 1) Select the GPS Status Page.
- 2) Press the **RAIM** Softkey.
- 3) Press the **FMS** Knob. The ‘WAYPOINT’ field is highlighted.
- 4) Turn the small **FMS** Knob to display the Waypoint Information Window.
- 5) Enter the desired waypoint and press the **ENT** Key (refer to Section 1.6 for instructions on data entry).  
**Or:**
  - a) To use the present position, press the **MENU** Key.
  - b) With ‘Set WPT to Present Position’ highlighted, press the **ENT** Key.
  - c) Press the **ENT** Key to accept the waypoint entry.
- 6) Enter an arrival time and press the **ENT** Key.
- 7) Enter an arrival date and press the **ENT** Key.
- 8) With the cursor highlighting ‘COMPUTE RAIM?’, press the **ENT** Key. Once RAIM availability is computed, one of the following is displayed:
  - ‘COMPUTE RAIM?’—RAIM has not been computed for the current waypoint, time, and date combination
  - ‘COMPUTING AVAILABILITY’—RAIM calculation in progress
  - ‘RAIM AVAILABLE’—RAIM is predicted to be available for the specified waypoint, time, and date
  - ‘RAIM NOT AVAILABLE’—RAIM is predicted to be unavailable for the specified waypoint, time, and date

## SATELLITE INFORMATION

Satellites currently in view are shown at their respective positions on a satellite constellation diagram. This sky view is always oriented north-up, with the outer circle representing the horizon, the inner circle representing 45° above the horizon, and the center point showing the position directly overhead. Each satellite is represented by an oval containing the Pseudo-random noise (PRN) number (i.e., satellite identification number). Satellites whose signals are currently being used are represented by solid ovals.

The GPS Status Page can be helpful in troubleshooting weak (or missing) signal levels due to poor satellite coverage or installation problems. As the GPS receiver locks onto satellites, a signal strength bar is displayed for each satellite in view, with the appropriate satellite PRN number (01-32 or 120-138 for SBAS) below each bar. The progress of satellite acquisition is indicated by signal bar appearance:

- No signal strength bar—Receiver is looking for the indicated satellite.
- Hollow signal strength bar—Receiver has found the satellite and is collecting data. Each satellite has a 30-second data transmission that must be collected (signal strength bar is hollow) before the satellite may be used for navigation (signal strength bar becomes solid).
- Solid signal strength bar—Receiver has collected the necessary data and the satellite signal can be used.
- Checkered signal strength bar—Receiver has excluded the satellite (Fault Detection and Exclusion; FDE).
- “D” indication on signal strength bar—Satellite is being used for differential computations.
- Green signal strength bar—Satellites that are actually being used in the position calculation.
- Blue signal strength bar—Satellite is locked on but not yet being used in the position calculation.

Using the current satellite signal information, the system calculates the aircraft's GPS position, time, altitude, ground speed, and track for the aircraft (displayed below the satellite signal accuracy measurements for reference). The following quantities denote the accuracy of the aircraft's GPS fix:

- Estimated Position Uncertainty (EPU)—A statistical error indication; the radius of a circle centered on an estimated horizontal position in which actual position has 95% probability of lying
- Horizontal Dilution of Precision (HDOP)—Measures satellite geometry quality (i.e., number of satellites received and where they are relative to each other) on a range from 0.0 to 9.9, with lower numbers denoting better accuracy
- Horizontal and Vertical Figures of Merit (HFOM and VFOM)—Measures of horizontal and vertical position uncertainty; the current 95% confidence horizontal and vertical accuracy values reported by the GPS receiver

# 1.5 G1000 CONTROLS

The G1000 controls have been designed to simplify operation of the system and minimize workload and the time required to access sophisticated functionality. Controls are located on the PFD and MFD bezels and Audio Panel. PFD and MFD controls and softkeys are discussed in this section. See the Audio Panel and CNS Section for more information about Audio Panel and NAV/COM controls. AFCS controls (on the bezel of the MFD) are described in the AFCS section.

## PFD/MFD CONTROLS

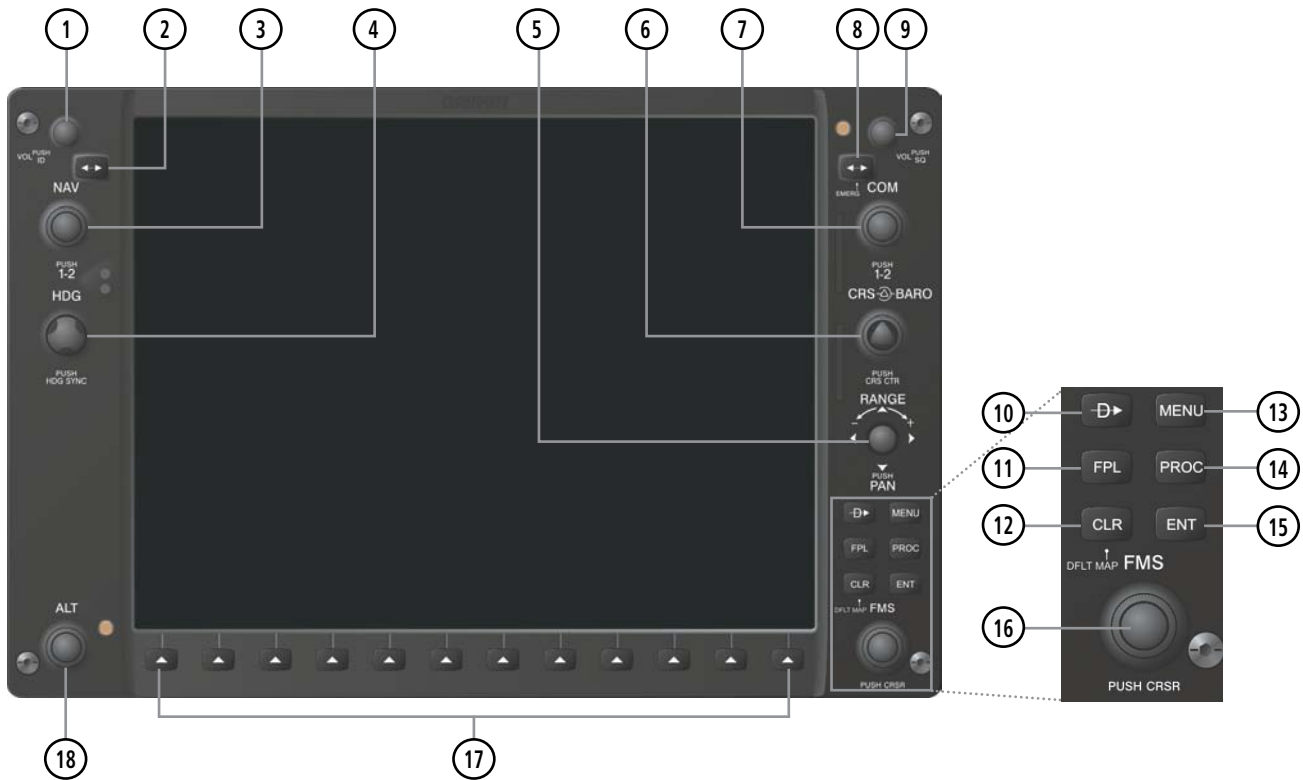

Figure 1-13 PFD/MFD Controls

The **NAV**, **CRS/BARO**, **COM**, **FMS**, and **ALT** knobs are concentric dual knobs, each having small (inner) and large (outer) control portion. When a portion of the knob is not specified in the text, either may be used.

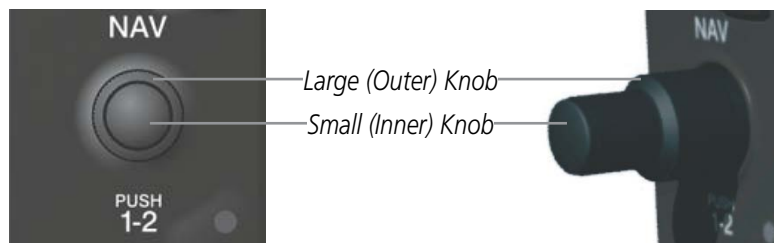



Figure 1-14 Dual Concentric Knob

- ① **NAV VOL/ID Knob** Turn to control NAV audio volume (shown in the NAV Frequency Box as a percentage)  
Press to toggle Morse code identifier audio on/off
- ② **NAV Frequency Transfer Key** Transfers the standby and active NAV frequencies
- ③ **NAV Knob** Turn to tune NAV receiver standby frequencies (large knob for MHz; small for kHz)  
Press to toggle light blue tuning box between NAV1 and NAV2
- ④ **Heading Knob** Turn to manually select a heading  
Press to display a digital heading momentarily to the left of the Horizontal Situation Indicator (HSI) and synchronize the Selected Heading to the and current heading
- ⑤ **Joystick** Turn to change map range  
Press to activate Map Pointer and move in desired direction to pan map
- ⑥ **CRS/BARO Knob** Turn large knob for altimeter barometric pressure setting  
Turn small knob to adjust course (only when HSI is in VOR or OBS Mode)  
Press to re-center the CDI and return course pointer directly to bearing of active waypoint/station
- ⑦ **COM Knob** Turn to tune COM transceiver standby frequencies (large knob for MHz; small for kHz)  
Press to toggle light blue tuning box between COM1 and COM2  
The selected COM (green) is controlled with the **COM MIC** Key (Audio Panel).
- ⑧ **COM Frequency Transfer Key (EMERG)** Transfers the standby and active COM frequencies  
Press and hold two seconds to tune the emergency frequency (121.5 MHz) automatically into the active frequency field
- ⑨ **COM VOL/SQ Knob** Turn to control COM audio volume level (shown as a percentage in the COM Frequency Box)  
Press to turn the COM automatic squelch on/off
- ⑩ **Direct-to Key**  Activates the direct-to function and allows the user to enter a destination waypoint and establish a direct course to the selected destination (specified by identifier, chosen from the active route)
- ⑪ **FPL Key** Displays flight plan information
- ⑫ **CLR Key (DFLT MAP)** Erases information, cancels entries, or removes menus  
Press and hold to display the MFD Navigation Map Page (MFD only).
- ⑬ **MENU Key** Displays a context-sensitive list of options for accessing additional features or making setting changes
- ⑭ **PROC Key** Gives access to IFR departure procedures (DPs), arrival procedures (STARs), and approach procedures (IAPs) for a flight plan or selected airport
- ⑮ **ENT Key** Validates/confirms selection or data entry

SYSTEM OVERVIEW

FLIGHT INSTRUMENTS

EIS

AUDIO PANEL & CNS

FLIGHT MANAGEMENT

HAZARD AVOIDANCE

AFCS

ADDITIONAL FEATURES

APPENDICES

INDEX

- ⑩ **FMS Knob (Flight Management System Knob)** Press to turn the selection cursor on/off

**Data Entry:** With cursor on, turn to enter data in the highlighted field (large knob moves cursor location; small knob selects character for highlighted cursor location)

**Scrolling:** When a list of information is too long for the window/box, a scroll bar appears, indicating more items to view. With cursor on, turn large knob to scroll through the list.

**Page Selection:** Turn knob on MFD to select the page to view (large knob selects a page group; small knob selects a specific page from the group)
- ⑪ **Softkey Selection Keys** Press to select softkey shown above the bezel key on the PFD/MFD display
- ⑫ **ALT Knob** Sets the Selected Altitude, shown above the Altimeter (the large knob selects the thousands, the small knob selects the hundreds)

### SOFTKEY FUNCTION

The softkeys are located along the bottoms of the displays. The softkeys shown depend on the softkey level or page being displayed. The bezel keys below the softkeys can be used to select the appropriate softkey. When a softkey is selected, its color changes to black text on gray background and remains this way until it is turned off, at which time it reverts to white text on black background. When a softkey function is disabled, the softkey label is subdued (dimmed).

Softkeys revert to the previous level after 45 seconds of inactivity.



Figure 1-15 Softkeys (Second-Level PFD Configuration)

In the following descriptions, top level softkeys are denoted with bullets.

### PFD SOFTKEYS

The **CDI**, **IDENT**, **TMR/REF**, **NRST**, and **ALERTS** softkeys undergo a momentary change to black text on gray background and automatically switch back to white text on black background when selected.

The PFD softkeys provide control over flight management functions, including GPS, NAV, terrain, traffic, and lightning (optional). Each softkey sublevel has a **BACK** Softkey which can be selected to return to the previous level. The **ALERTS** Softkey is visible at all softkey levels (label changes if messages are issued).

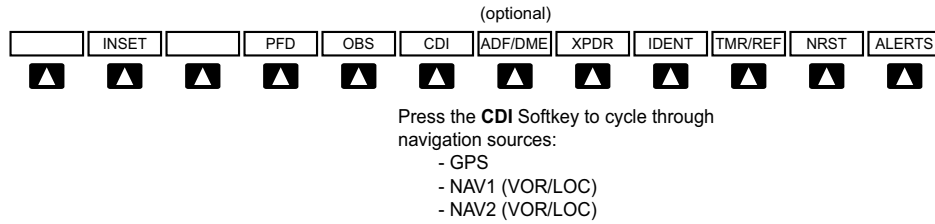

Figure 1-16 Top Level PFD Softkeys

- **INSET** Displays Inset Map in PFD lower left corner
- OFF** Removes Inset Map
- DCLTR (3)** Selects desired amount of map detail; cycles through declutter levels:
  - DCLTR (No Declutter): All map features visible
  - DCLTR-1: Removes land data
  - DCLTR-2: Removes land and SUA data
  - DCLTR-3: Removes everything except active flight plan
- TRAFFIC (2)** Displays/removes traffic information on Inset Map
  - TRFC-1: Displays traffic on Inset Map.
  - TRFC-2: Removes everything except traffic. Inset Map position HDG UP only.
- TOPO** Displays/removes topographical data (e.g., coastlines, terrain, rivers, lakes) on Inset Map
- TERRAIN** Displays/removes terrain information on Inset Map
- STRMSCP** Displays/removes Stormscope weather information on Inset Map (optional)
- NEXRAD** Displays/removes NEXRAD weather and coverage information on Inset Map (optional)
- XM LTNG** Displays/removes XM lightning information on Inset Map (optional)
- METAR** Displays METAR flags on airport symbols shown on the Inset Map (optional)

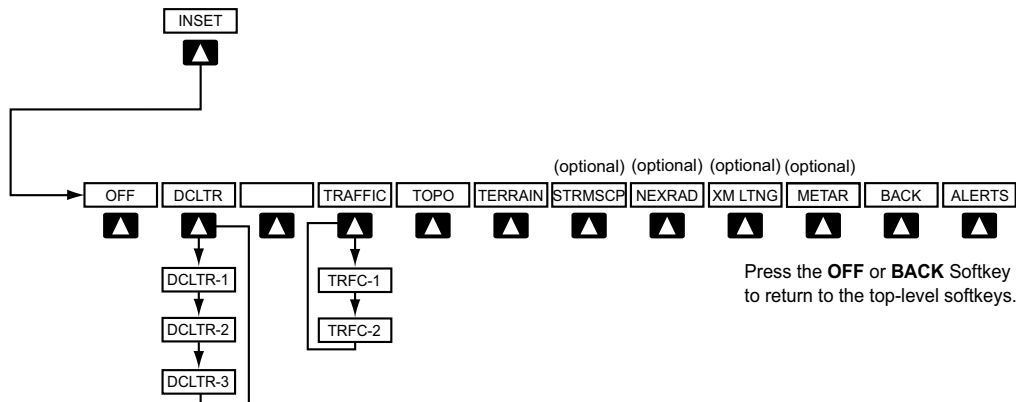

Figure 1-17 INSET Softkeys



- **PFD** Displays second-level softkeys for additional PFD configuration
- SYN VIS** Displays the softkeys for enabling or disabling Synthetic Vision features
- PATHWAY** Displays rectangular boxes representing the horizontal and vertical flight path of the active flight plan
- SYN TERR** Enables synthetic terrain depiction
- HRZN HDG** Displays compass heading along the Zero-Pitch line
- APTSIGNS** Displays position markers for airports within approximately 15 nm of the current aircraft position. Airport identifiers are displayed when the airport is within approximately 9 nm.
- DFLTS** Resets PFD to default settings, including changing units to standard
- WIND** Displays softkeys to select and configure wind data
  - OPTN1** Displays wind data in longitudinal and lateral components
  - OPTN2** Displays wind data total direction and speed
  - OPTN3** Displays wind data total direction with head and cross-wind speed components
  - OFF** Removes wind information from display
- DME** Displays/removes DME Information Window (*optional*)
- BRG1** Cycles the Bearing 1 Information Window through:
  - NAV1: Waypoint frequency/identifier and DME information
  - GPS: Waypoint identifier and GPS distance information
  - ADF: Waypoint frequency
  - Off: Removes window
- HSI FMT** Displays softkeys to select the HSI format
  - 360 HSI** Displays HSI as a 360° compass rose
  - ARC HSI** Displays HSI as a 140° viewable arc (Bearing Information windows unavailable)
- BRG2** Cycles the Bearing 2 Information Window through:
  - NAV2: Waypoint frequency/identifier and DME information
  - GPS: Waypoint identifier and GPS distance information
  - ADF: Waypoint frequency
  - Off: Removes window
- ALT UNIT** Displays softkeys for changing the Altimeter barometric setting and altitude displays to metric units
  - METERS** Displays the current and Selected altitudes in meters in addition to feet, when selected
  - IN** Displays the Altimeter barometric setting in inches of mercury (in Hg)
  - HPA** Displays the Altimeter barometric setting in hectopascals (hPa)
  - STD BARO** Sets barometric pressure to 29.92 in Hg (1013 hPa if metric display is selected)
- **OBS** Selects OBS Mode on the CDI when navigating by GPS (only available with active leg)
- **CDI** Cycles CDI through GPS, NAV1 (VOR/LOC), and NAV2 (VOR/LOC) navigation sources
- **ADF/DME** Displays/removes ADF/DME Radio Tuning Window (*optional*; may appear as **ADF**, **DME**, or **ADF/DME** depending on installation)



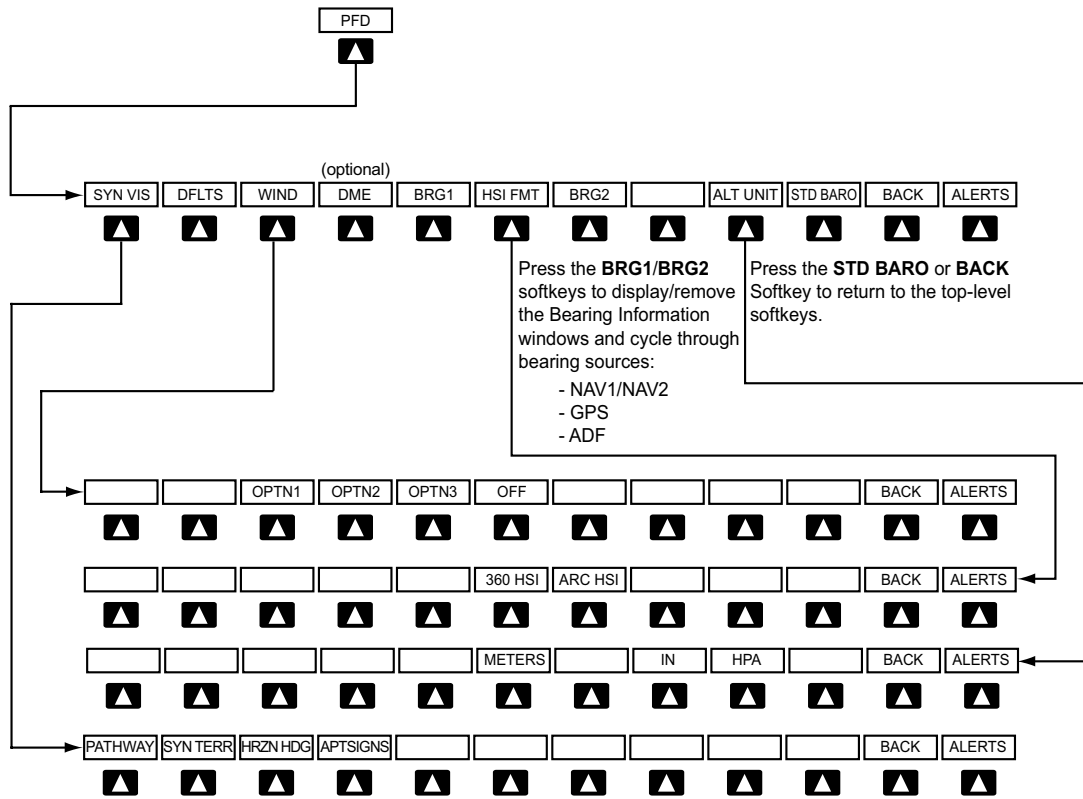

Figure 1-18 PFD Configuration Softkeys

- **XPDR** Displays transponder mode selection softkeys:
- **STBY** Selects standby mode (Transponder does not reply to any interrogations)
- **ON** Selects Mode A (Transponder replies to interrogations)
- **ALT** Selects Mode C – altitude reporting mode (Transponder replies to identification and altitude interrogations)
- **GND** Manually selects Ground Mode (Transponder does not allow Mode A and Mode C replies, but does permit acquisition squitter and replies to discretely addressed Mode S interrogations)
- **VFR** Automatically enters the VFR code (1200 in U.S.A. only)
- **CODE** Displays transponder code selection softkeys 0-7
  - **0 — 7** Use numbers to enter code
  - **BKSP** Removes numbers entered, one at a time
- **IDENT** Activates the Special Position Identification (SPI) pulse for 18 seconds, identifying the transponder return on the ATC screen
- **TMR/REF** Displays/removes Timer/References Window
- **NRST** Displays/removes Nearest Airports Window
- **ALERTS** Displays/removes Alerts Window

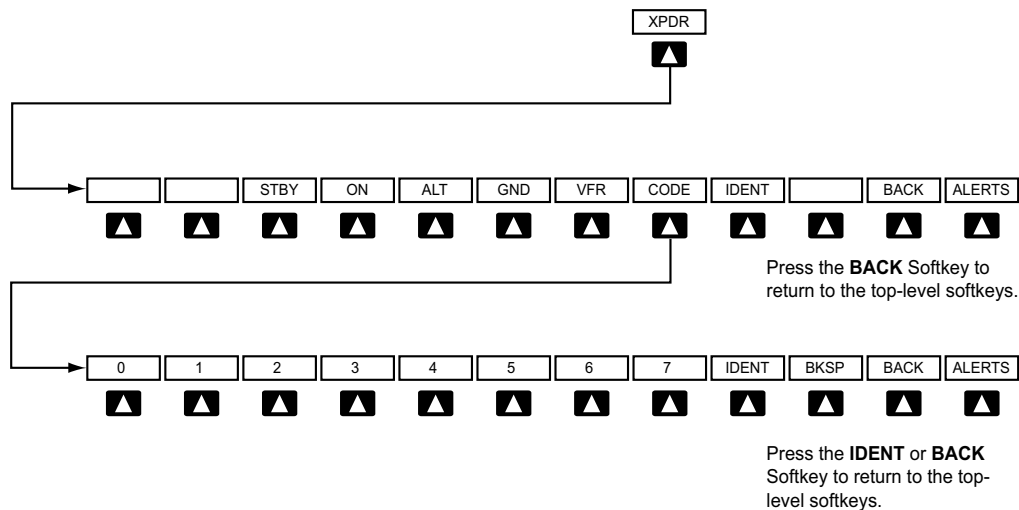

Figure 1-19 XPDR Softkeys

MFD SOFTKEYS

MFD softkeys vary depending on the page selected. EIS and Navigation Map Page (default MFD page) softkeys are described here.

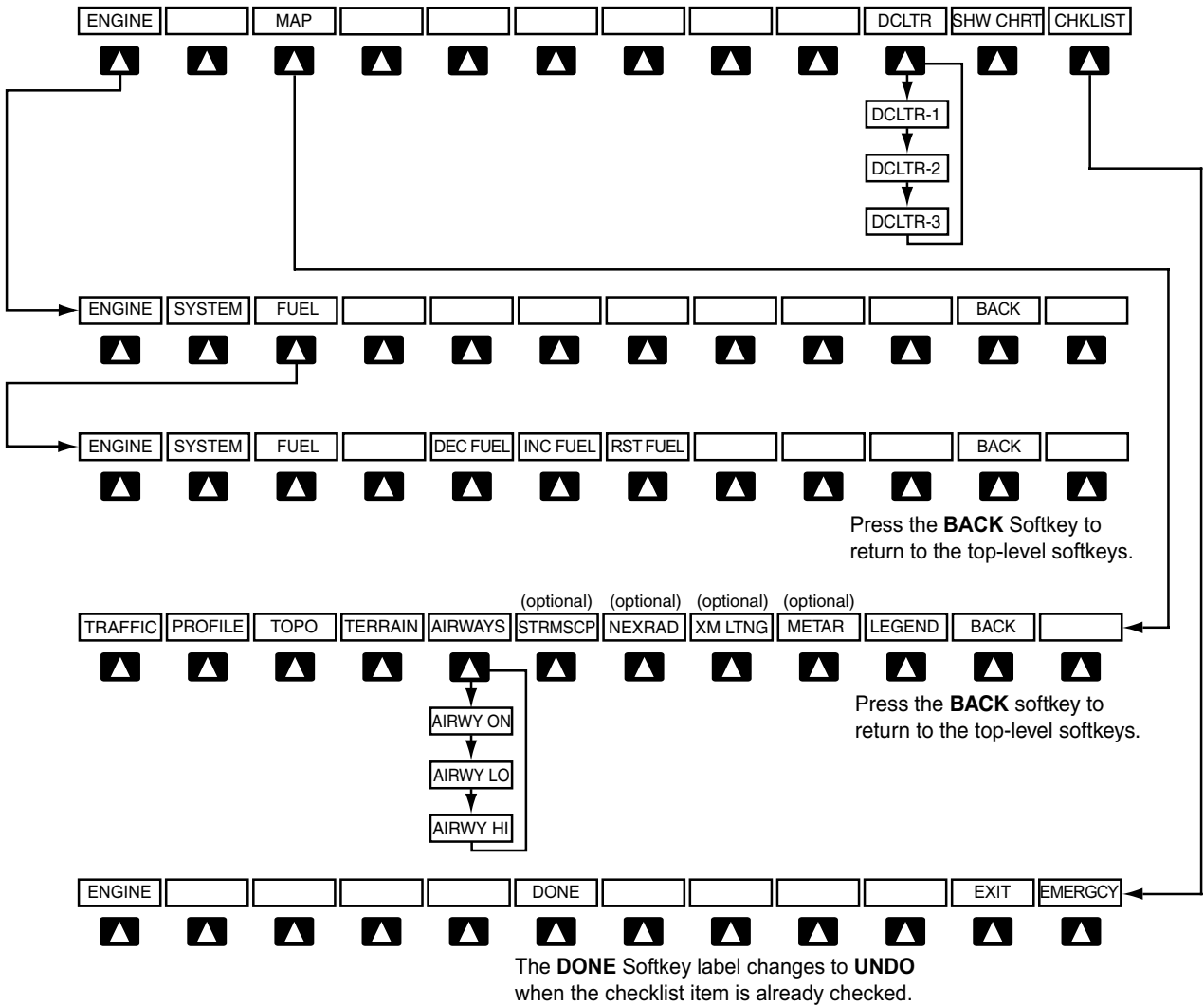

Figure 1-20 EIS and MFD Softkeys

- **ENGINE** Displays the Engine Page and top-level engine softkeys (see the EIS Section for more information)
- SYSTEM** Displays the System Page
- FUEL** Displays the Fuel Page
- DEC FUEL** Decreases displayed fuel remaining in 1-gal increments
- INC FUEL** Increases displayed fuel remaining in 1-gal increments
- RST FUEL** Resets displayed fuel remaining to maximum fuel capacity for aircraft and fuel used to zero

- **MAP** Enables second-level Navigation Map Page softkeys
- TRAFFIC** Displays/removes traffic information on Navigation Map Page
- PROFILE** Displays/removes profile view on Navigation Map Page
- TOPO** Displays/removes topographical data (e.g., coastlines, terrain, rivers, lakes) on Navigation Map Page
- TERRAIN** Displays/removes terrain information on Navigation Map Page
- AIRWAYS** Selects the desired display of Airways; cycles through:
  - AIRWY ON: All Airways displayed
  - AIRWY LO: Low Altitude (Victor) Airways displayed
  - AIRWY HI: High Altitude Airways (Jet Routes) displayed
  - AIRWAYS: Airways are not displayed
- STRMSCP** Displays/removes Stormscope weather information on Inset Map (*optional*)
- NEXRAD** Displays/removes NEXRAD weather/coverage on Navigation Map Page (*optional*)
- XM LTNG** Displays/removes XM lightning information on Navigation Map Page (*optional*)
- METAR** Displays METAR flags on airport symbols shown on Navigation Map Page (*optional*)
- LEGEND** Displays the legend for the selected weather products. Available only when NEXRAD, XM LTNG, and/or METAR softkeys are selected.
- BACK** Returns to top-level softkeys
- **DCLTR (3)** Selects desired amount of map detail; cycles through declutter levels:
  - DCLTR (No Declutter): All map features visible
  - DCLTR-1: Removes land data
  - DCLTR-2: Removes land and SUA data
  - DCLTR-3: Removes everything except the active flight plan
- **SHW CHRT** Displays optional Flite Charts or Chart View charts (*optional*)
- **CHKLIST** Displays the Checklist Page
- DONE** Selects the highlighted checklist item
- EXIT** Returns to the top-level softkeys
- EMERGCY** Immediately accesses the emergency procedures

## 1.6 ACCESSING G1000 FUNCTIONALITY

### MENUS

The G1000 has a dedicated **MENU** Key that when pressed displays a context-sensitive list of options. This options list allows the user to access additional features or make settings changes which specifically relate to the currently displayed window/page. There is no all-encompassing menu. Some menus provide access to additional submenus that are used to view, edit, select, and review options. Menu display 'No Options' when there are no additional features or settings for the window/page selected.

#### Navigating a menu:

- 1) Press the **MENU** Key to display the menu.
- 2) Turn the **FMS** Knob to scroll through a list of available options (a scroll bar always appears to the right of the window/box when the option list is longer than the window/box).
- 3) Press the **ENT** Key to select the desired option.
- 4) Press the **CLR** Key or **FMS** Knob to remove the menu and cancel the operation.



Figure 1-21 Page Menu Examples

### DATA ENTRY

The **FMS** Knob can be used for directly entering alphanumeric data (e.g., Flight ID, waypoint identifiers, barometric minimum descent altitude) into the G1000. In some instances, such as when entering an identifier, the G1000 tries to predict the desired identifier based on the characters being entered. In this case, if the desired identifier appears, use the **ENT** Key to confirm the entry without entering the rest of the identifier manually. This can save the pilot from having to enter all the characters of the identifier.

Besides character-by-character data entry, the system also provides a shortcut for entering waypoint identifiers. When the cursor is on a field awaiting entry of a waypoint identifier, turning the small **FMS** Knob counter-clockwise accesses three different lists of waypoint identifiers for quick selection: flight plan (FPL), nearest (NRST), and recently-entered (RECENT). The G1000 automatically fills in the identifier, facility, and city fields with the information for the selected waypoint.

**Using the FMS Knob to enter data:**

- 1) If needed, press the **FMS** Knob to activate the cursor.
- 2) Use the large **FMS** Knob to highlight the desired field.
- 3) Begin entering data.
  - a) To quickly enter a waypoint identifier, turn the small **FMS** Knob counter-clockwise to display a list of waypoints in the active flight plan (list is titled FPL). If desired, turn the small **FMS** Knob clockwise to scroll through lists of nearest waypoints (NRST) and recently-entered waypoints (RECENT).
  - b) Turn the large **FMS** Knob to highlight the desired waypoint from the list and press the **ENT** Key.  
**Or:**
    - a) Turn the small **FMS** Knob to select a character for the first placeholder.  
Turning the knob clockwise scrolls through the alphabet (where appropriate) toward the letter Z, starting at K, and the digits zero through nine. Afterwards, turning the knob counter-clockwise scrolls in the opposite direction.
    - b) Use the large **FMS** Knob to move the cursor to the next placeholder in the field.
    - c) Repeat, using the small **FMS** Knob to select a character and the large **FMS** Knob to move the cursor, until the field is complete.
    - d) Press the **ENT** Key to confirm entry.
- 4) Press the **FMS** Knob or **CLR** Key to cancel data entry (the field reverts back to its previous information).

PAGE GROUPS



**NOTE:** Refer to other supporting sections in this Pilot's Guide for details on specific pages.

Information on the MFD is presented on pages which are grouped according to function. The page group and active page title are displayed in the upper center of the screen, below the Navigation Status Box. In the bottom right corner of the screen, the current page group, number of pages available in the group, and placement of the current page within the group are indicated by icons. For some of these pages (Airport/Procedures/Weather Information, XM, Procedure Loading), the title of the page changes while the page icon remains the same.

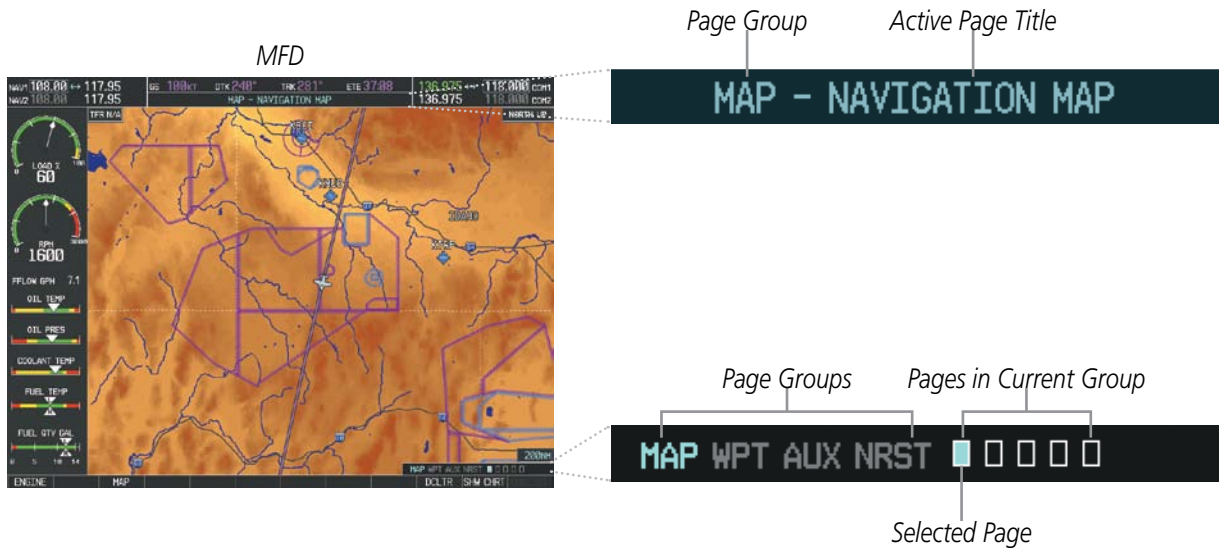

Figure 1-22 Page Title and Page Group Icons

There are four main page groups, navigated using the **FMS** Knob; specific pages within each group can vary depending on the configuration of optional equipment.

**Selecting a page using the FMS Knob:**

- 1) Turn the large **FMS** Knob until the desired page group is selected.
- 2) Turn the small **FMS** Knob until the desired page is selected.

There are also several pages (Airport/Procedures/Weather Information and XM pages) which are selected first from within a main page group with the **FMS** Knob, then with the appropriate softkey at the bottom of the page (or from the page menu). In this case, the page remains set to the selected page until a different page softkey is selected, even if a different page group is selected.



SYSTEM OVERVIEW

FLIGHT INSTRUMENTS

EIS

AUDIO PANEL & CNS

FLIGHT MANAGEMENT

HAZARD AVOIDANCE

AFCS

ADDITIONAL FEATURES

APPENDICES

INDEX

• **Map Page Group (MAP)**

- Navigation Map
- Traffic Map
- Stormscope (optional)
- Weather Data Link (optional)
- Terrain Proximity

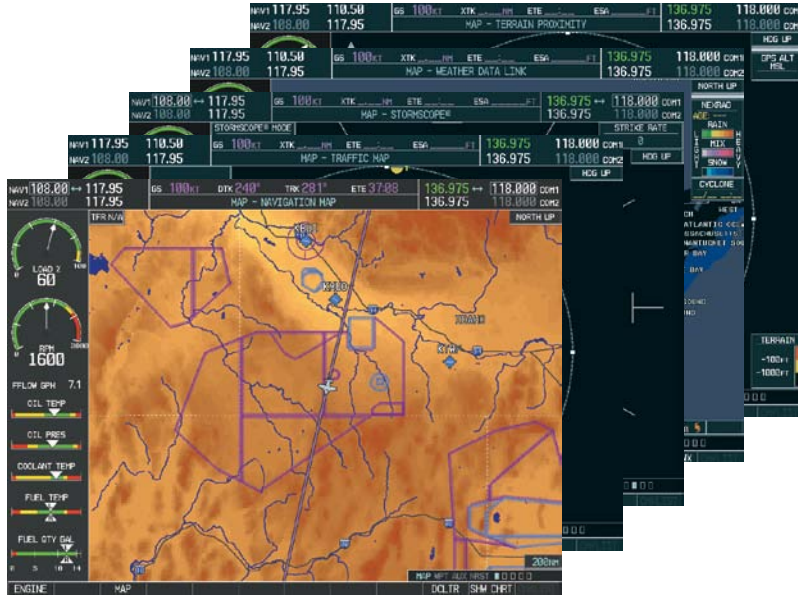

Figure 1-23 Map Pages

• **Waypoint Page Group (WPT)**

Airport/Procedures/Weather Information Pages

- Airport Information (**INFO** Softkey)
- Departure Information (**DP** Softkey)
- Arrival Information (**STAR** Softkey)
- Approach Information (**APR** Softkey)
- Weather Information (optional) (**WX** Softkey)
- Intersection Information
- NDB Information
- VOR Information
- User Waypoint Information

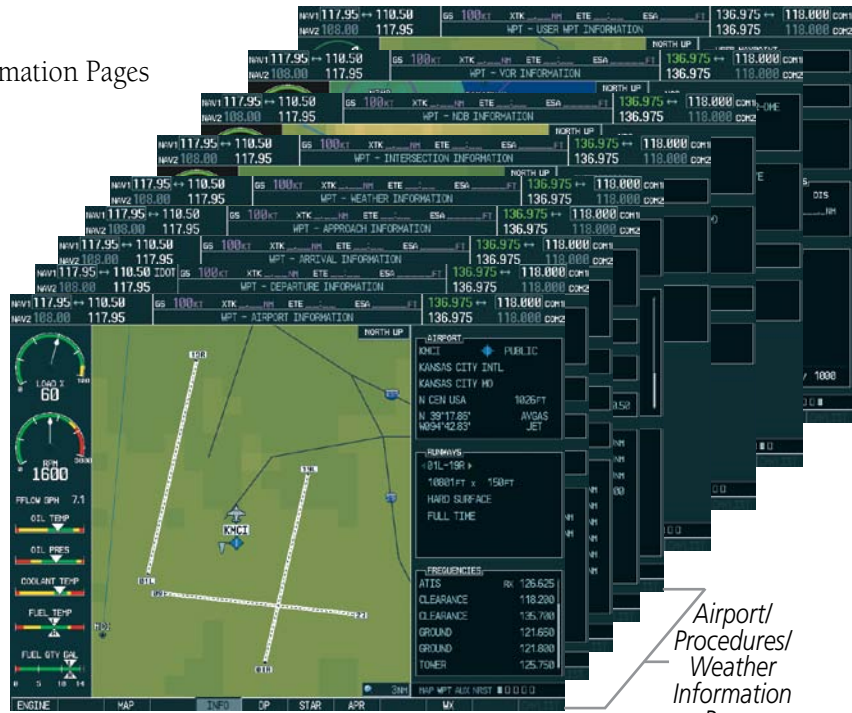

Figure 1-24 Waypoint Pages



### • Auxiliary Page Group (AUX)

- Trip Planning
- Utility
- GPS Status
- System Setup
- XM Satellite screens (*optional*)
  - XM Information (**INFO** Softkey)
  - XM Radio (**RADIO** Softkey)
- System Status
- Video (*optional*)



Figure 1-25 Auxiliary Pages

### • Nearest Page Group (NRST)

- Nearest Airports
- Nearest Intersections
- Nearest NDB
- Nearest VOR
- Nearest User Waypoints
- Nearest Frequencies
- Nearest Airspaces

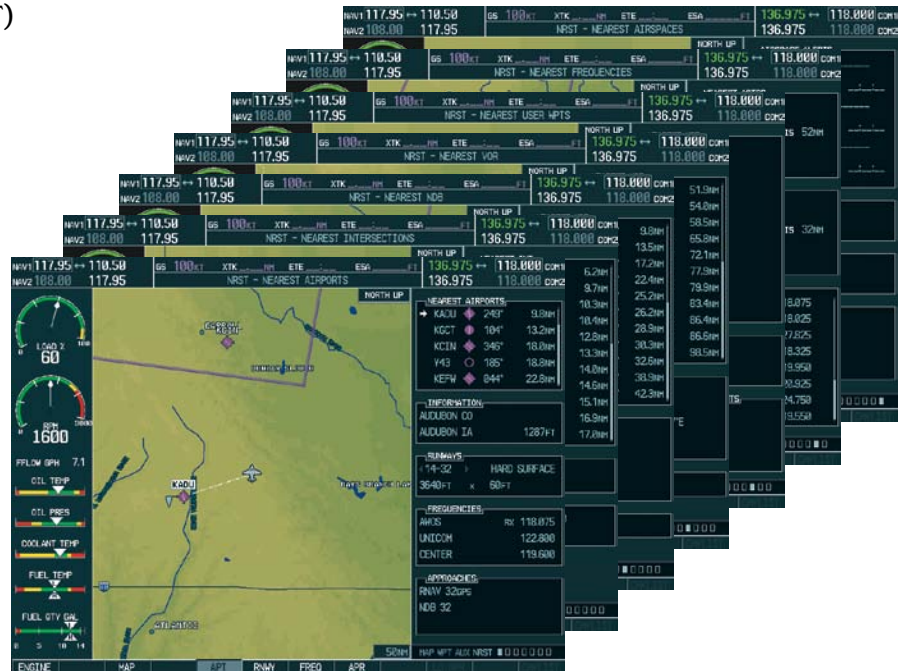

Figure 1-26 Nearest Pages

In addition to the main page groups accessed exclusively using the **FMS** Knob, there are pages for flight planning (FPL) and loading procedures (PROC) which are accessed by key. In some instances, softkeys may be used to access the Procedure Loading pages.

The Flight Plan pages are accessed using the **FPL** Key on the MFD. Main pages within this group are selected by turning the small **FMS** Knob.

• **Flight Plan Page Group (FPL)**

- Active Flight Plan
- Flight Plan Catalog
- Stored Flight Plan (**NEW** Softkey)



Figure 1-27 Flight Plan Pages

The Procedure Loading pages may be accessed at any time on the MFD by pressing the **PROC** Key. A menu is initialized, and when a departure, approach, or arrival is selected, the appropriate Procedure Loading page is opened. These pages can also be accessed from the Active and Stored Flight Plan pages using the **LD** softkeys. Turning the **FMS** Knob does not scroll through the Procedure Loading pages (note the single page icon in the lower right corner).

• **Procedure Loading Page Group (PROC)**

- Departure Loading
- Arrival Loading
- Approach Loading



Figure 1-28 Procedure Loading Pages

Information on optional electronic checklist pages is offered later in this section. Checklist pages may be accessed from any page on the MFD using the **CHKLIST** Softkey.

**SYSTEM SETTINGS**

G1000 system settings are managed from the System Setup Page. The following settings can be changed:

- Date/time
- Display Units (see Flight Instruments Section)
- Airspace alerts (see Flight Management Section)
- Arrival alerts (see Flight Management Section)
- MFD Navigation Status Box fields (see Flight Management Section)
- CDI scaling for GPS navigation source (see Flight Instruments Section)
- COM channel spacing (see Audio Panel and CNS Section)
- Criteria for displaying nearest airports (see Flight Management Section)
- Audio Alerts

**Restoring system setup defaults:**

- 1) Use the **FMS** Knob to select the AUX - System Setup Page.
  - 2) Press the **DFLTS** Softkey.
- Or:
- a) Press the **MENU** Key.
  - b) Highlight 'Restore Defaults' and press the **ENT** Key.



Figure 1-29 System Setup Page

## DATE/TIME

The G1000 obtains the current Universal Coordinated Time (UTC) date and time directly from the GPS satellite signals (shown on the AUX - GPS Status Page, Figure 1-11). System time (displayed in the lower right corner of the PFD) can be displayed in three formats: local 12-hr, local 24-hr, or UTC. Local time is set by adding/subtracting an offset (hours:minutes) to/from UTC.

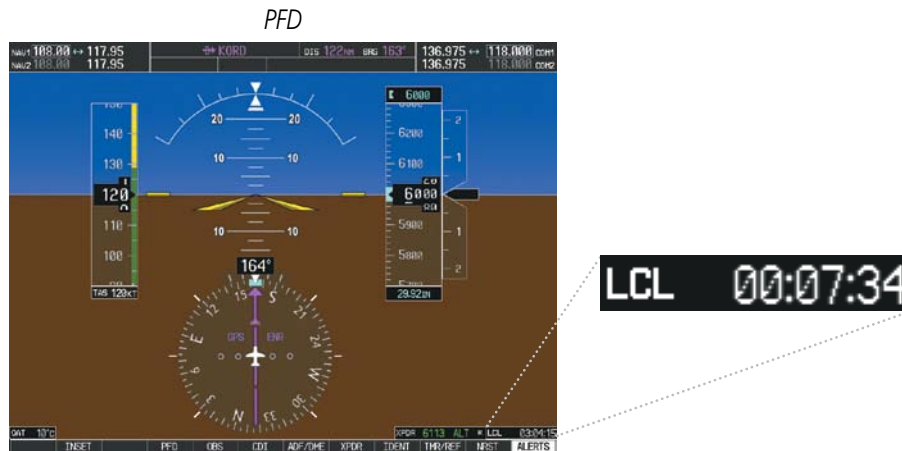

Figure 1-30 System Time (Local 24-hr Format)

### Configuring the system time:

- 1) Select the AUX - System Setup Page using the **FMS** Knob.
- 2) Press the **FMS** Knob to activate the cursor.
- 3) Turn the large **FMS** Knob to highlight the 'Time Format' field.
- 4) Turn the small **FMS** Knob to select the desired format and press the **ENT** Key to confirm selection. The 'Time Offset' field is highlighted.
- 5) Use the **FMS** Knob to enter the desired time offset ( $\pm$ HH:MM) and press the **ENT** Key to confirm selection.



Figure 1-31 Date/Time Settings (AUX - System Setup Page)



**DISPLAY UNITS**

Units in which various quantities are displayed on the G1000 screens are listed on the System Setup Page. The Navigation Angle reference can be set from here (refer to the Flight Instruments Section).

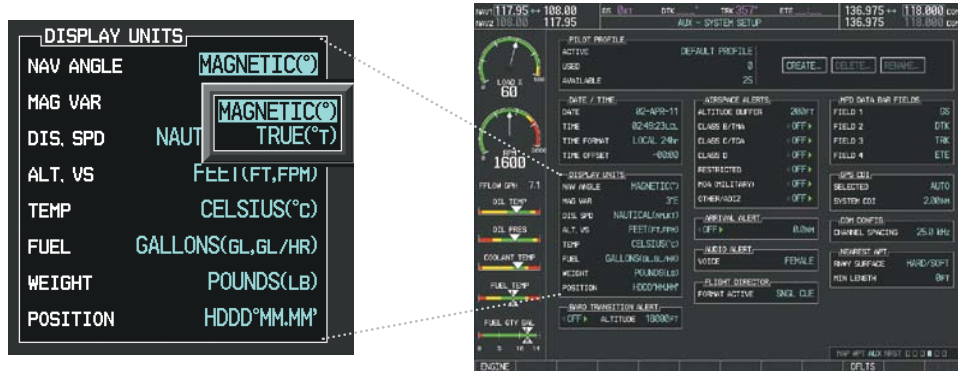

Figure 1-32 Display Unit Settings (AUX - System Setup Page)

Category	Settings	Affected Quantities	Exceptions
Navigation Angle	Magnetic (North) True (North)	Heading Course Bearing Track Desired Track Wind direction (Trip Planning Page)	
Distance and Speed	Metric Nautical	Crosstrack error (HSI) Bearing distances (information windows) DME distance (information window) Flight plan distances Map ranges DIS, GS, TAS, XTK fields (Navigation Status Box) All distances on MFD Altitude buffer distance (System Setup) Arrival Alert trigger distance (System Setup) All speeds on MFD	Airspeed Indicator True Airspeed (PFD) Wind speed vector Map range (Traffic Page, Terrain Proximity/TAWS Page) CDI scaling (System Setup) Fuel range calculation (EIS)
Altitude and Vertical Speed	Feet Meters	All altitudes on MFD All elevations on MFD	Altimeter Vertical Speed Indicator VNV altitudes (Active Flight Plan)
Temperature	Celsius Fahrenheit	All temperatures on PFD Total Air Temperature (Trip Planning Page)	Engine Indication System (EIS)
Fuel and Fuel Flow	Gallons Imp Gallons Kilograms Liters Pounds	Fuel parameters (Trip Planning Page)	Engine Indication System (EIS)
Weight	Pounds Kilograms	N/A	N/A
Position	HDDD°MM.MM' HDDD°MM'SS.S" MGRS UTM/UPS	All positions	N/A

Table 1-1 Display Units Settings (AUX - System Setup Page)

- SYSTEM OVERVIEW
- FLIGHT INSTRUMENTS
- EIS
- AUDIO PANEL & CNS
- FLIGHT MANAGEMENT
- HAZARD AVOIDANCE
- AFCS
- ADDITIONAL FEATURES
- APPENDICES
- INDEX

## PILOT PROFILES

System settings may be saved under a pilot profile. When the system is powered on, the last selected pilot profile is shown on the MFD Power-up Splash Screen (Figure 1-5). The G1000 can store up to 25 profiles; the currently active profile, the amount of memory used, and the amount of memory available are shown at the top of the System Setup Page in the box labeled 'Pilot Profile'. From here, pilot profiles may be created, selected, renamed, or deleted.



Figure 1-33 Display Unit Settings (AUX - System Setup Page)

### Creating a profile:

- 1) Use the **FMS** Knob to select the AUX - System Setup Page.
- 2) Press the **FMS** Knob momentarily to activate the flashing cursor.
- 3) Turn the large **FMS** Knob to highlight 'CREATE' in the Pilot Profile Box.
- 4) Press the **ENT** Key. A 'Create Profile' window is displayed.
- 5) Use the **FMS** Knob to enter a profile name up to 16 characters long and press the **ENT** Key. Pilot profile names cannot begin with a blank as the first letter.
- 6) In the next field, use the small **FMS** Knob to select the desired settings upon which to base the new profile. Profiles can be created based on Garmin factory defaults, default profile settings (initially based on Garmin factory defaults unless edited by the pilot), or current system settings.
- 7) Press the **ENT** Key.

- 8) With 'CREATE' highlighted, press the **ENT** Key to create the profile

**Or:**

Use the large **FMS** Knob to select 'CREATE and ACTIVATE' and press the **ENT** Key to activate the new profile.

- 9) To cancel the process, select 'CANCEL' with the large FMS Knob and press the **ENT** Key.

#### Selecting an active profile:

- 1) Use the **FMS** Knob to select the AUX - System Setup Page.
- 2) Press the **FMS** Knob momentarily to activate the flashing cursor.
- 3) Turn the large **FMS** Knob to highlight the active profile field in the Pilot Profile Box.
- 4) Turn the small **FMS** Knob to display the pilot profile list and highlight the desired profile.
- 5) Press the **ENT** Key. The G1000 loads and displays the system settings for the selected profile.

#### Renaming a profile:

- 1) Use the **FMS** Knob to select the AUX - System Setup Page.
- 2) Press the **FMS** Knob momentarily to activate the flashing cursor.
- 3) Turn the large **FMS** Knob to highlight 'RENAME' in the Pilot Profile Box.
- 4) Press the **ENT** Key.
- 5) In the 'Rename Profile' window, turn the **FMS** Knob to select the profile to rename.
- 6) Press the **ENT** Key.
- 7) Use the **FMS** Knob to enter a new profile name up to 16 characters long and press the **ENT** Key.
- 8) With 'RENAME' highlighted, press the **ENT** Key.
- 9) To cancel the process, use the large **FMS** Knob to select 'CANCEL' and press the **ENT** Key.

#### Deleting a profile:

- 1) Use the **FMS** Knob to select the AUX - System Setup Page.
- 2) Press the **FMS** Knob momentarily to activate the flashing cursor.
- 3) Turn the large **FMS** Knob to highlight 'DELETE' in the Pilot Profile Box.
- 4) Press the **ENT** Key.
- 5) In the 'Delete Profile' window, turn the **FMS** Knob to select the profile to delete.
- 6) Press the **ENT** Key.
- 7) With 'DELETE' highlighted, press the **ENT** Key.
- 8) To cancel the process, use the large **FMS** Knob to select 'CANCEL' and press the **ENT** Key.



**TIMERS**

The G1000 timers available include:

- Stopwatch-like generic timers (available from the PFD Timer/References Window and on the MFD AUX - Utility Page)
- Total-time-in-flight timer (MFD AUX - Utility Page)
- Time since departure (MFD AUX - Utility Page)

The generic timer can be set to count up or down from a specified time (HH:MM:SS). When the countdown on the timer reaches zero the digits begin to count up from zero. If the timer is reset before reaching zero on a countdown, the digits are reset to the initial value. If the timer is counting up when reset, the digits are zeroed.

**Setting the generic timer (PFD):**

- 1) Press the **TMR/REF** Softkey.
- 2) Turn the large **FMS** Knob to select the timer field (hh/mm/ss).
- 3) Use the **FMS** Knob to enter the desired time and press the **ENT** Key.
- 4) With the UP/DN field highlighted, turn the small **FMS** Knob to select the timer counting direction.
- 5) Press the **ENT** Key.
- 6) With 'START?' highlighted, press the **ENT** Key to start the timer. The field changes to 'STOP?'.
- 7) To stop the timer, press the **ENT** Key with 'STOP?' highlighted. The field changes to 'RESET?'.
- 8) To reset the timer, press the **ENT** Key with 'RESET?' highlighted. The field changes back to 'START?' and the digits are reset.
- 9) To remove the window, press the **CLR** Key or the **TMR/REF** Softkey.

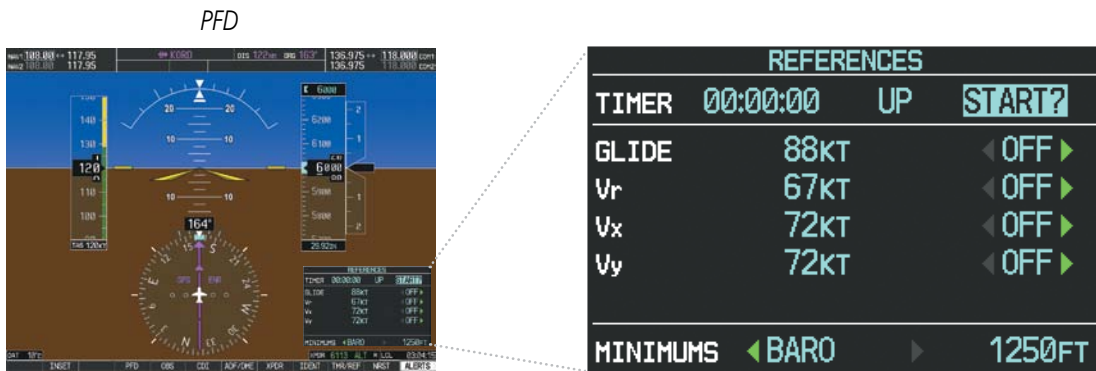

Figure 1-34 Generic Timer (Timer/References Window)

The flight timer can be set to count up from zero starting at system power-up or from the time that the aircraft lifts off; the timer can also be reset to zero at any time.

### Setting the generic timer (MFD AUX - Utility Page):

- 1) Use the **FMS** Knob to select the AUX - Utility Page.
- 2) Press the **FMS** Knob momentarily to activate the flashing cursor.
- 3) Turn the small **FMS** Knob to select the timer counting direction (UP/DN) and press the **ENT** Key.
- 4) If a specific starting time is desired:
  - a) Use the large **FMS** Knob to highlight the HH:MM:SS field.
  - b) Use the **FMS** Knob to enter the desired time and press the **ENT** Key.
- 5) Turn the large **FMS** Knob to highlight 'START?' and press the **ENT** Key to start the timer. The field changes to 'STOP?'.
- 6) To stop the timer, press the **ENT** Key with 'STOP?' highlighted. The field changes to 'RESET?'.
- 7) To reset the timer, press the **ENT** Key with 'RESET?' highlighted. The field changes back to 'START?' and the digits are reset.



Figure 1-35 Timers (AUX - Utility Page)

### Setting the flight timer starting criterion:

- 1) Use the **FMS** Knob to select the AUX - Utility Page.
- 2) Press the **FMS** Knob momentarily to activate the flashing cursor.
- 3) Turn the large **FMS** Knob to highlight the field next to the flight timer.
- 4) Turn the small **FMS** Knob to select the starting criterion (PWR-ON or IN-AIR) and press the **ENT** Key.

### Resetting the flight timer:

- 1) Use the **FMS** Knob to select the AUX - Utility Page.
- 2) Press the **MENU** Key.
- 3) With 'Reset Flight Timer' highlighted, press the **ENT** Key.

The G1000 records the time at which departure occurs, depending on whether the pilot prefers the time to be recorded from system power-up or from aircraft lift off. The displayed departure time can also be reset to display the current time at the point of reset. The format in which the time is displayed is controlled from the System Setup Page.

#### Setting the departure timer starting criterion:

- 1) Use the **FMS** Knob to select the AUX - Utility Page.
- 2) Press the **FMS** Knob momentarily to activate the flashing cursor.
- 3) Turn the large **FMS** Knob to highlight the field next to the departure time.
- 4) Turn the small **FMS** Knob to select the starting criterion (PWR-ON or IN-AIR) and press the **ENT** Key.

#### Resetting the departure time:

- 1) Use the **FMS** Knob to select the AUX - Utility Page.
- 2) Press the **MENU** Key.
- 3) Use the **FMS** Knob to highlight 'Reset Departure Time' and press the **ENT** Key.

## 1.7 DISPLAY BACKLIGHTING

The backlighting of the PFD and MFD displays and bezel and Audio Panel keys can be adjusted automatically or manually. The default setting (automatic backlighting adjustment) uses photocell technology to automatically adjust for ambient lighting conditions. Photocell calibration curves are pre-configured to optimize display appearance through a broad range of cockpit lighting conditions. Manual backlighting adjustment can be accomplished using the existing instrument panel dimmer bus or the following procedures. In normal operating mode, backlighting can only be adjusted from the PFD. In Reversionary Mode, it can be adjusted from the remaining display.

### Adjusting display backlighting:

- 1) Press the PFD **MENU** Key to display the PFD Setup Menu. 'AUTO' is now highlighted next to 'PFD DSPL'.
- 2) Turn the small **FMS** Knob to select 'MANUAL'.
- 3) Press the **ENT** Key. The intensity value is now highlighted.
- 4) Use the **FMS** Knob to enter the desired backlighting then press the **ENT** Key.
- 5) Turn the large **FMS** Knob to highlight 'AUTO' next to 'MFD DSPL' and repeat steps 2-4.
- 6) To remove the menu, press the **CLR** or **MENU** Key.

### Adjusting key backlighting:

- 1) Press the PFD **MENU** Key to display the PFD Setup Menu. 'AUTO' is now highlighted next to 'PFD DSPL'.
- 2) Turn the large **FMS** Knob to highlight 'PFD DSPL'.
- 3) Turn the small **FMS** Knob in the direction of the green arrowhead to display 'PFD KEY'.
- 4) Turn the large **FMS** Knob to highlight 'AUTO'.
- 5) Turn the small **FMS** Knob to select 'MANUAL'.
- 6) Press the **ENT** Key. The intensity value is now highlighted.
- 7) Use the **FMS** Knob to enter the desired backlighting and press the **ENT** Key.
- 8) Turn the large **FMS** Knob to highlight 'MFD DSPL'.
- 9) Turn the small **FMS** Knob in the direction of the green arrowhead to display 'MFD KEY' and repeat steps 4-7.
- 10) To remove the menu, press the **CLR** or **MENU** Key.

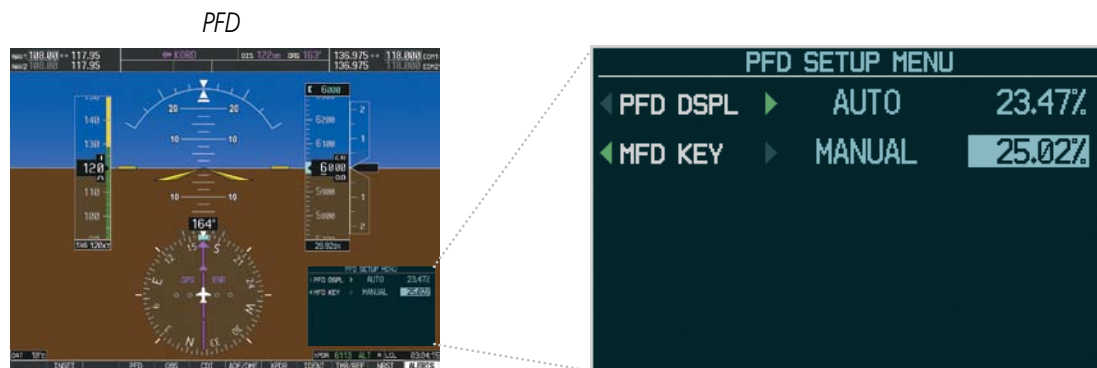

Figure 1-36 PFD Setup Menu

## SECTION 2 FLIGHT INSTRUMENTS



**WARNING:** If the airspeed, attitude, altitude, or heading indications become unusable, refer to the backup instruments.



**NOTE:** The optional Automatic Flight Control System (AFCS) provides additional readouts and bugs on selected flight instruments. Refer to the AFCS Section for details on these bugs and readouts, as they appear on the display during certain AFCS modes.

Increased situational awareness is provided by replacing the traditional instruments on the panel with an easy-to-scan Primary Flight Display (PFD) that features a large horizon, airspeed, attitude, altitude, vertical speed, and course deviation information. In addition to the flight instruments, navigation, communication, terrain, traffic, and weather information are also presented on the PFD and explained in other sections of this Pilot's Guide.

The following flight instruments and supplemental flight data are displayed on the PFD:

- Airspeed Indicator, showing
  - Indicated airspeed
  - True airspeed
  - Airspeed awareness ranges
  - Vspeed reference flags
- Attitude Indicator with slip/skid indication
- Altimeter, showing
  - Trend vector
  - Barometric setting
  - Selected altitude
- Vertical Deviation, Glideslope, and Glidepath Indicators
- Vertical Speed Indicator (VSI)
- Vertical Navigation (VNV) indications
- Outside air temperature (OAT)
- Horizontal Situation Indicator, showing
  - Turn Rate Indicator
  - Bearing pointers and information windows
  - Navigation source
  - Course Deviation Indicator (CDI)
  - Bearing pointers and information windows
  - DME Information Window (optional)
- Transponder Mode, Code, and Ident/Reply
- Course Deviation Indicator (CDI)
- Timer/References Window, showing
  - Generic timer
  - Vspeed values
  - Barometric minimum descent altitude (MDA)
- Wind data

The PFD also displays various alerts and annunciations.



- |  |                                  |
|--|----------------------------------|
| ① NAV Frequency Box                    | ⑫ Turn Rate Indicator            |
| ② Airspeed Indicator                   | ⑬ Barometric Altimeter Setting   |
| ③ True Airspeed                        | ⑭ Vertical Speed Indicator (VSI) |
| ④ Current Heading                      | ⑮ Selected Altitude Bug          |
| ⑤ Current Track Indicator              | ⑯ Altimeter                      |
| ⑥ Horizontal Situation Indicator (HSI) | ⑰ Selected Altitude              |
| ⑦ Outside Air Temperature (OAT)        | ⑱ COM Frequency Box              |
| ⑧ Softkeys                             | ⑲ Navigation Status Box          |
| ⑨ System Time                          | ⑳ Slip/Skid Indicator            |
| ⑩ Transponder Data Box                 | ㉑ Attitude Indicator             |
| ⑪ Heading Bug                          |                                  |

Figure 2-1 Primary Flight Display (Default)



- |  |                                |
|--|--------------------------------|
| ① Traffic Annunciation                         | ⑩ Annunciation Window          |
| ② Selected Heading                             | ⑪ Selected Course              |
| ③ Vspeed Reference                             | ⑫ Vertical Speed Required      |
| ④ Wind Data                                    | ⑬ Vertical Deviation Indicator |
| ⑤ Inset Map                                    | ⑭ Marker Beacon Annunciation   |
| ⑥ DME Information Window                       | ⑮ Current VNV Target Altitude  |
| ⑦ Bearing Information Windows                  | ⑯ TERRAIN-SVS Annunciation     |
| ⑧ Minimum Descent Altitude/<br>Decision Height | ⑰ AFCS Status Annunciation     |
| ⑨ Flight Plan Window                           |                                |

Figure 2-2 Additional PFD Information



## 2.1 FLIGHT INSTRUMENTS

### AIRSPPEED INDICATOR



**NOTE:** Refer to the Aircraft Flight Manual (AFM) for airspeed criteria and Vspeed values.

The Airspeed Indicator displays airspeed on a moving tape rolling number gauge. The true airspeed is displayed in knots below the Airspeed Indicator. The numeric labels and major tick marks on the moving tape are shown at intervals of 10 knots. The minor tick marks on the moving tape are shown at intervals of five knots. Speed indication starts at 20 knots, with 60 knots of airspeed viewable at any time. The indicated airspeed is displayed inside the black pointer. The pointer remains black until reaching never-exceed speed ( $V_{NE}$ ), at which point it turns red.

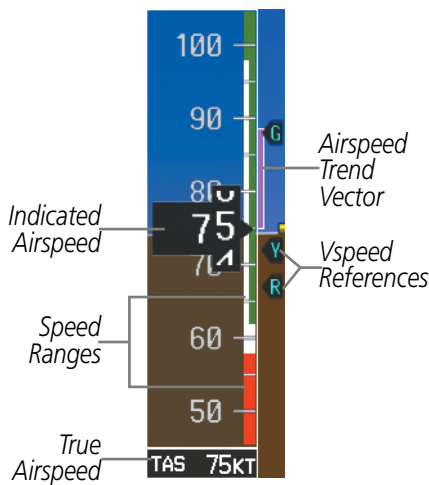

Figure 2-3 Airspeed Indicator



Figure 2-4 Red Pointer Showing Overspeed  $V_{NE}$

A color-coded (white, green, yellow, and red) speed range strip is located on the moving tape. The colors denote flaps operating range, normal operating range, caution range, and never-exceed speed ( $V_{NE}$ ).

The Airspeed Trend Vector is a vertical, magenta line, extending up or down on the airspeed scale, shown to the right of the color-coded speed range strip. The end of the trend vector corresponds to the predicted airspeed in 6 seconds if the current rate of acceleration is maintained. If the trend vector crosses  $V_{NE}$ , the text of the actual airspeed readout changes to yellow. The trend vector is absent if the speed remains constant or if any data needed to calculate airspeed is not available due to a system failure.

Vspeeds (Glide,  $V_R$ ,  $V_X$ , and  $V_Y$ ) can be changed and their flags turned on/off from the Timer/References Window. When active (on), the Vspeeds are displayed at their respective locations to the right of the airspeed scale. By default, all Vspeed values are reset and all flags turned off when power is cycled.

**Changing Vspeeds and turning Vspeed flags on/off:**

- 1) Press the **TMR/REF** Softkey.
- 2) Turn the large **FMS** Knob to highlight the field of the desired Vspeed to be changed.
- 3) Use the **FMS** Knob to enter the desired value. When a speed has been changed from a default value, an asterisk appears next to the speed (Figure 2-5).
- 4) Press the **ENT** Key or turn the large **FMS** Knob to highlight the ON/OFF field.
- 5) Turn the small **FMS** Knob clockwise to ON or counterclockwise to OFF.
- 6) To remove the window, press the **CLR** Key or the **TMR/REF** Softkey.

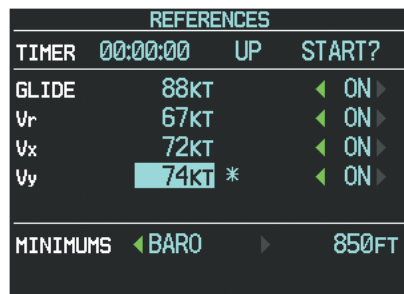

Figure 2-5 Timer/References Window

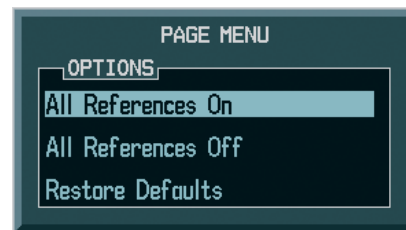

Figure 2-6 Timer/References Menu

**Turning all Vspeed flags on/off:**

- 1) Press the **TMR/REF** Softkey.
- 2) Press the **MENU** Key.
- 3) To activate all Vspeed flags, press the **ENT** Key with 'All References On' highlighted.
- 4) To remove all Vspeed flags, turn the **FMS** Knob to highlight 'All References Off' and press the **ENT** Key.

**Restoring all Vspeed defaults:**

- 1) Press the **TMR/REF** Softkey.
- 2) Press the **MENU** Key.
- 3) Turn the **FMS** Knob to highlight 'Restore Defaults' and press the **ENT** Key.

## ATTITUDE INDICATOR

Attitude information is displayed over a virtual blue sky and brown ground with a white horizon line. The Attitude Indicator displays the pitch, roll, and slip/skid information.

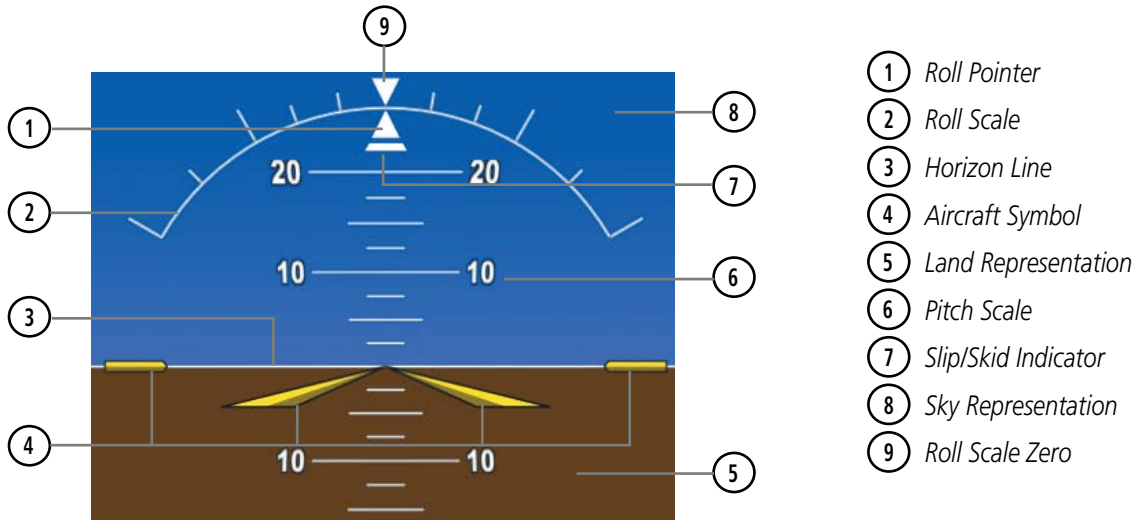

Figure 2-7 Attitude Indicator

The horizon line is part of the pitch scale. Above and below the horizon line, major pitch marks and numeric labels are shown for every 10°, up to 80°. Minor pitch marks are shown for intervening 5° increments, up to 25° below and 45° above the horizon line. Between 20° below to 20° above the horizon line, minor pitch marks occur every 2.5°. Refer to the Additional Features section for details regarding attitude indicator operation when the Synthetic Vision System (optional) is active.

The inverted white triangle indicates zero on the roll scale. Major tick marks at 30° and 60° and minor tick marks at 10°, 20°, and 45° are shown to the left and right of the zero. Angle of bank is indicated by the position of the pointer on the roll scale.

The Slip/Skid Indicator is the bar beneath the roll pointer. The indicator moves with the roll pointer and moves laterally away from the pointer to indicate lateral acceleration. Slip/skid is indicated by the location of the bar relative to the pointer. One bar displacement is equal to one ball displacement on a traditional Slip/Skid Indicator.



Figure 2-8 Slip/Skid Indication

**ALTIMETER**

The Altimeter displays 600 feet of barometric altitude values at a time on a moving tape rolling number gauge. Numeric labels and major tick marks are shown at intervals of 100 feet. Minor tick marks are at intervals of 20 feet. The indicated altitude is displayed inside the black pointer.

The Selected Altitude is displayed above the Altimeter in the box indicated by a selection bug symbol. A bug corresponding to this altitude is shown on the tape. If the Selected Altitude exceeds the range shown on the tape, the bug appears at the upper or lower edge of the tape. When the metric value is selected it is displayed in a separate box above the Selected Altitude.

**Setting the Selected Altitude:**

Turn the **ALT** Knob to set the Selected Altitude (large knob for 1000-ft increments, small knob for 100-ft increments.)

If set, the Minimum Descent Altitude/Decision Height (MDA/DH) value is also available for the Selected Altitude.

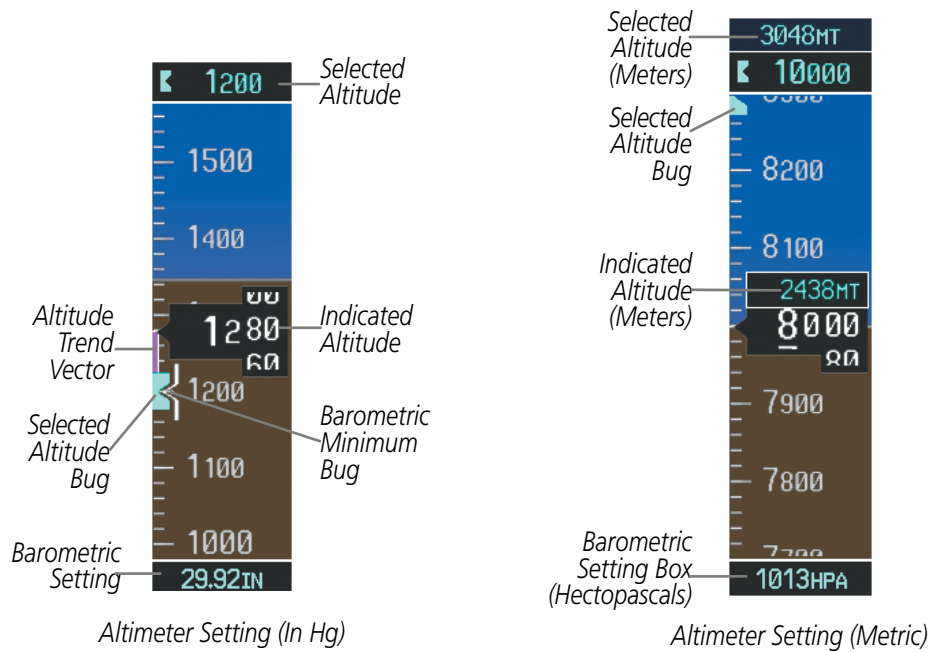

Figure 2-9 Altimeter Settings, In Hg and Metric

Altitudes can also be displayed in meters. Note that the altitude tape does not change scale.

#### Displaying altitude in meters:

- 1) Press the **PFD** Softkey to display the second-level softkeys.
- 2) Press the **ALT UNIT** Softkey.
- 3) Press the **METERS** Softkey to turn on metric altitude readouts.
- 4) Press the **BACK** Softkey to return to the top-level softkeys.

When the altitude is displayed in meters, the large and small **ALT** Knobs adjust the Selected Altitude in 500 meter and 50 meter increments respectively.

A magenta Altitude Trend Vector extends up or down the left of the altitude tape, the end resting at the approximate altitude to be reached in six seconds at the current vertical speed. The trend vector is not shown if altitude remains constant or if data needed for calculation is not available due to a system failure.

The barometric pressure setting is displayed below the Altimeter in inches of mercury (in Hg) or hectopascals (hPa) when metric units are selected. Adjusting the altimeter barometric pressure setting creates discontinuities in VNV vertical navigation, moving the descent path. For large adjustments, it may take several minutes for the aircraft to re-establish on the descent patch. If the change is made while nearing a waypoint with a VNV Target Altitude, the aircraft may not re-establish on the descent path in time to meet the vertical constraint.

#### Selecting the altimeter barometric pressure setting:

Turn the **BARO** Knob to select the desired setting.

#### Selecting standard barometric pressure (29.92 in Hg):

- 1) Press the **PFD** Softkey to display the second-level softkeys.
- 2) Press the **STD BARO** Softkey.

#### Changing altimeter barometric pressure setting units:

- 1) Press the **PFD** Softkey to display the second-level softkeys.
- 2) Press the **ALT UNIT** Softkey.
- 3) Press the **IN** Softkey to display the barometric pressure setting in inches of mercury (in Hg).  
Or, press the **HPA** Softkey to display the barometric pressure setting in hectopascals (hPa).
- 4) Press the **BACK** Softkey to return to the top-level softkeys.

A Baro Transition Alert is provided to alert the pilot to change the barometric pressure setting when crossing the transition altitude in either direction. This is displayed by the flashing light blue barometric pressure setting when crossing the transition altitude. The flashing stops when the barometric pressure setting is changed.

**Setting the Baro Transition Alert:**

- 1) Use the **FMS** Knob to select the AUX - System Setup Page on the MFD.
- 2) Press the **FMS** Knob to activate the cursor.
- 3) Turn the large **FMS** Knob to highlight Altitude in the Baro Transition Alert box.
- 4) Turn the small **FMS** Knob to turn the alert OFF or ON and press the **ENT** Key.
- 5) Turn the small **FMS** Knob to change the altitude and press the **ENT** Key.
- 6) To cancel the selection, press the **FMS** Knob.

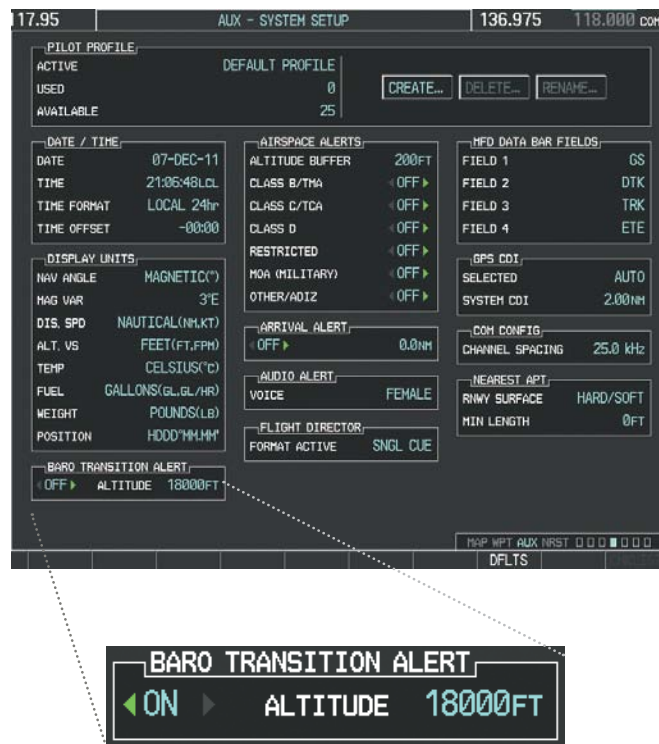

Figure 2-10 Aux - System Setup Page, Baro Transition Alert

**VERTICAL SPEED INDICATOR (VSI)**

The Vertical Speed Indicator (VSI) displays the aircraft vertical speed on a fixed scale with labels at 1000 and 2000 fpm and minor tick marks every 500 fpm. Digits appear in the pointer when the climb or descent rate is greater than 100 fpm. If the rate of ascent/descent exceeds 2000 fpm, the pointer appears at the edge of the tape and the rate appears inside the pointer.

## VERTICAL DEVIATION

**NOTE:** The Glidepath Indicator is only shown for aircraft with GIA 63W Integrated Avionics Units when SBAS is available.

The Vertical Deviation Indicator (VDI) is a magenta chevron indicating the baro-VNV vertical deviation when Vertical Navigation (VNV) is being used. The VDI appears in conjunction with the “TOD within 1 minute” alert. The VDI is removed from the display if vertical deviation becomes invalid. See the Flight Management Section for details on VNV features, and refer to Section 2.2, Supplemental Flight Data, for more information about VNV indications on the PFD.

The Glideslope Indicator appears to the left of the Altimeter whenever an ILS frequency is tuned in the active NAV field. A green diamond acts as the Glideslope Indicator, like a glideslope needle on a conventional indicator. If a localizer frequency is tuned and there is no glideslope, “NO GS” is heard.

The glidepath is analogous to the glideslope for GPS approaches supporting SBAS vertical guidance (LNAV+V, L/VNAV, LPV). When an approach of this type is loaded into the flight plan and GPS is the selected navigation source, the Glidepath Indicator appears as a magenta diamond during the approach. If the Glidepath Indicator becomes unavailable past the final approach fix (FAF), “NO GP” is heard.

Full-scale deflection of two dots is 1000 feet.

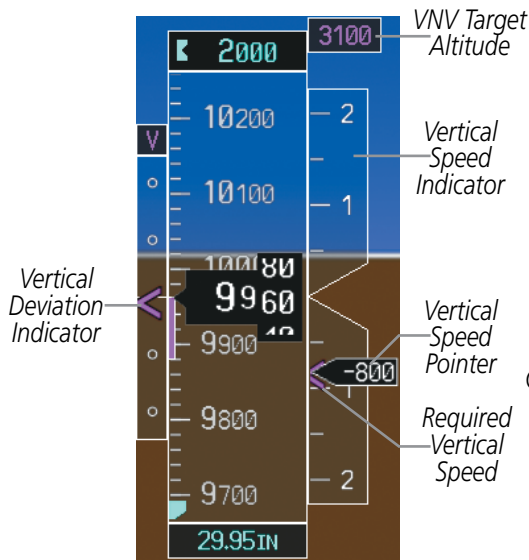

Figure 2-11 Vertical Speed and Deviation Indicators (VSI and VDI)

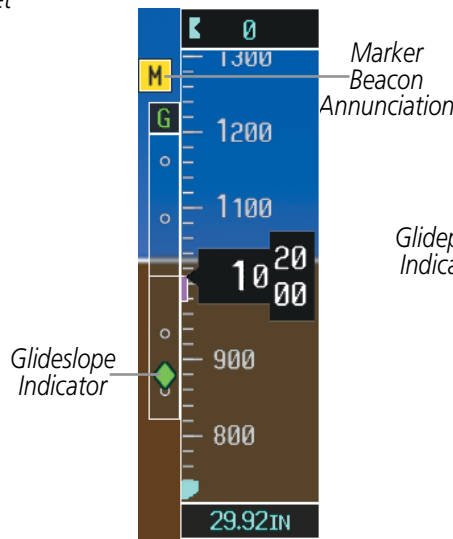

Figure 2-12 Glideslope Indicator

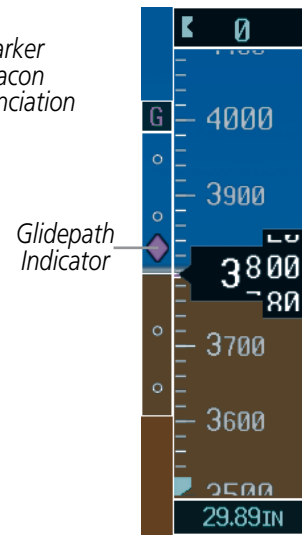

Figure 2-13 Glidepath Indicator



## HORIZONTAL SITUATION INDICATOR (HSI)

The Horizontal Situation Indicator (HSI) displays a rotating compass card in a heading-up orientation. Letters indicate the cardinal points with numeric labels every 30°. Major tick marks are at 10° intervals and minor tick marks are at 5° intervals. A digital reading of the current heading appears on top of the HSI, and the current track is represented on the HSI by a magenta diamond. The HSI also presents turn rate, course deviation, bearing, and navigation source information. The HSI is available in two formats, a 360° compass rose and a 140° arc.

### Changing the HSI display format:

- 1) Press the **PFD** Softkey.
- 2) Press the **HSI FRMT** Softkey.
- 3) Press the **360 HSI** or **ARC HSI** Softkey.

The 360° HSI contains a Course Deviation Indicator (CDI), with a Course Pointer, To/From Indicator, and a sliding deviation bar and scale. The course pointer is a single line arrow (GPS, VOR1, and LOC1) or a double line arrow (VOR2 and LOC2) which points in the direction of the set course. The To/From arrow rotates with the course pointer and is displayed when the active NAVAID is received.

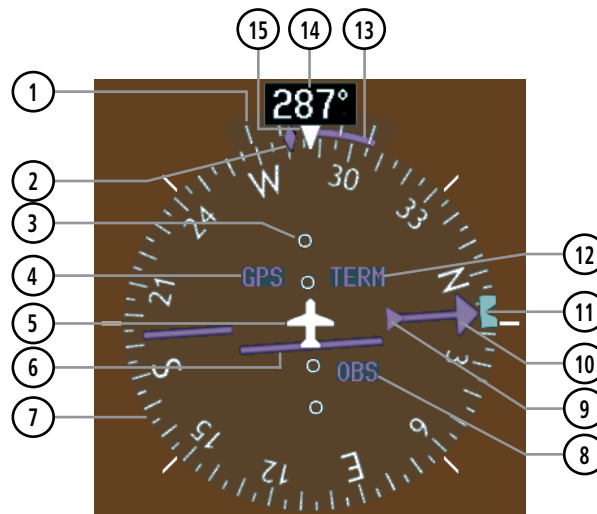

- |                                    |                                  |
|------------------------------------|----------------------------------|
| ① Turn Rate Indicator              | ⑨ To/From Indicator              |
| ② Current Track Bug                | ⑩ Course Pointer                 |
| ③ Lateral Deviation Scale          | ⑪ Heading Bug                    |
| ④ Navigation Source                | ⑫ Flight Phase                   |
| ⑤ Aircraft Symbol                  | ⑬ Turn Rate/Heading Trend Vector |
| ⑥ Course Deviation Indicator (CDI) | ⑭ Current Heading                |
| ⑦ Rotating Compass Rose            | ⑮ Lubber Line                    |
| ⑧ OBS Mode Active                  |                                  |

Figure 2-14 Horizontal Situation Indicator (HSI)

The Arc HSI is a 140° expanded section of the compass rose. The Arc HSI contains a Course Pointer, combined To/From Indicator and a sliding deviation indicator, and a deviation scale. Upon station passage, the To/From Indicator flips and points to the tail of the aircraft, just like a conventional To/From flag. Depending on the navigation source, the CDI on the Arc HSI can appear in two different ways, an arrowhead (GPS, VOR, OBS) or a diamond (LOC).

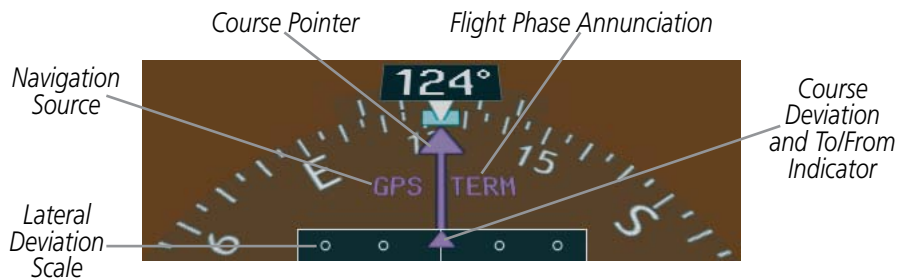

Figure 2-15 Arc HSI

The selected heading is shown to the upper left of the HSI for 3 seconds after being adjusted. The light blue heading bug on the compass rose corresponds to the selected heading. While the HSI is displayed as an arc, if the heading bug is adjusted off the shown portion of the compass rose, the digital reading is displayed.

**Adjusting the Selected Heading:**

Turn the **HDG** Knob to set the Selected Heading.

Press the **HDG** Knob to synchronize the bug to the current heading.

The Selected Course is shown to the upper right of the HSI for 3 seconds after being adjusted. While the HSI is displayed as an arc, the Selected Course is displayed whenever the Course Pointer is not within the 140° currently shown.

**Adjusting the Selected Course:**

Turn the **CRS** Knob to set the Selected Course.

Press the **CRS** Knob to re-center the CDI and return the course pointer to the bearing of the active waypoint or navigation station.

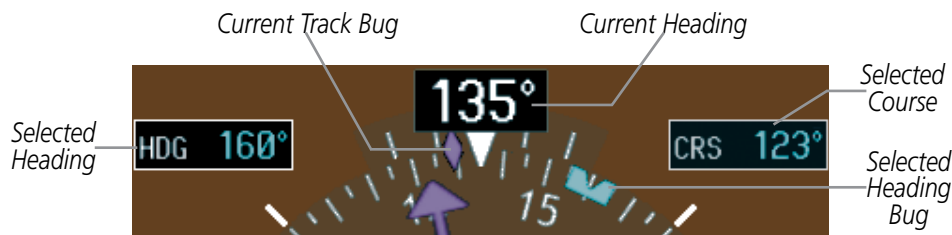

Figure 2-16 Heading and Course Indications

Navigation angles (track, heading, course, bearing) are corrected to the computed magnetic variation (Mag Var) or referenced to true north (T), set on the AUX - System Setup Page. When an approach referenced to true north has been loaded into the flight plan, the system generates a message to change the navigation angle setting to True at the appropriate time.



Figure 2-17 Heading and Course Indications (True)

**Changing the navigation angle true/magnetic setting:**

- 1) Use the **FMS** Knob to select the AUX - System Setup Page on the MFD.
- 2) Press the **FMS** Knob to activate the cursor.
- 3) Turn the large **FMS** Knob to highlight Nav Angle in the Display Units box.
- 4) Turn the small **FMS** Knob to highlight the desired setting and press the **ENT** Key.
  - TRUE - References angles to true north (T)
  - MAGNETIC - Angles corrected to the computed magnetic variation (Mag Var)



Figure 2-18 AUX - System Setup Page, Navigation Angle Settings

## TURN RATE INDICATOR

The Turn Rate Indicator is located directly above the rotating compass card. Tick marks to the left and right of the lubber line denote half-standard and standard turn rates. A magenta Turn Rate Trend Vector shows the current turn rate. The end of the trend vector gives the heading predicted in 6 seconds, based on the present turn rate. A standard-rate turn is shown on the indicator by the trend vector stopping at the standard turn rate tick mark, corresponding to a predicted heading of 18° from the current heading. At rates greater than 4 deg/sec, an arrowhead appears at the end of the magenta trend vector and the prediction is no longer valid.



Figure 2-19 Turn Rate Indicator and Trend Vector

## BEARING POINTERS AND INFORMATION WINDOWS

Two bearing pointers and associated information can be displayed on the HSI for NAV, GPS, and ADF sources by pressing the **PF**D Softkey then a **BRG** or **DME** Softkey. The bearing pointers are light blue and are single-line (BRG1) or double-line (BRG2). A pointer symbol is shown in the information windows to indicate the navigation source. The bearing pointers never override the CDI and are visually separated from the CDI by a white ring. Bearing pointers may be selected but not necessarily visible due to data unavailability.

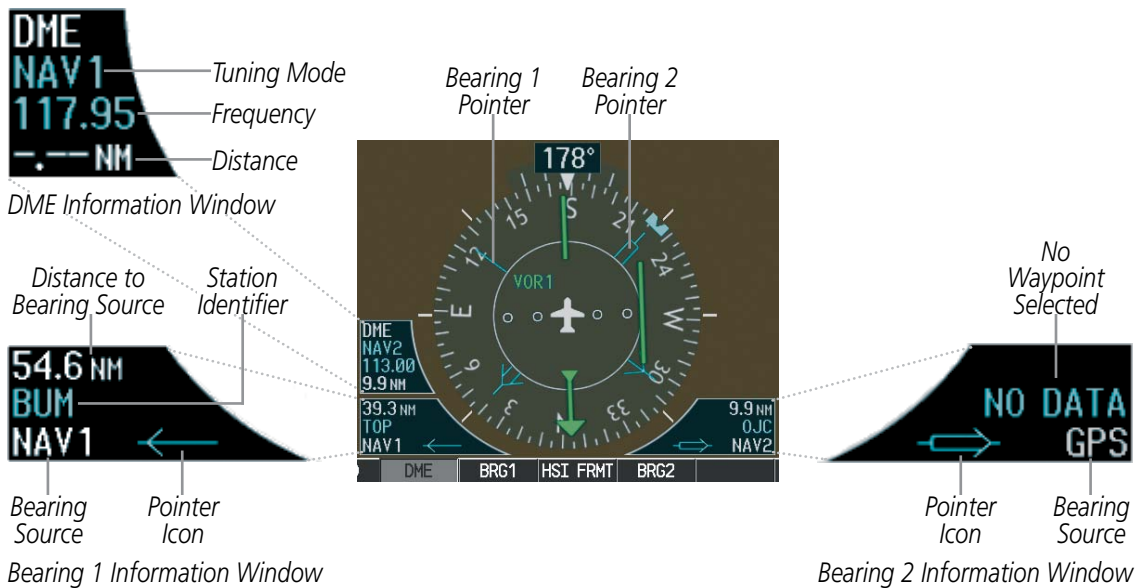

Figure 2-20 HSI with Bearing and DME Information

When a bearing pointer is displayed, the associated information window is also displayed. The Bearing Information Windows are displayed at the lower sides of the HSI and give the following information:



**NOTE:** *ADF installation is optional.*

- Bearing source (NAV, GPS, ADF)
- Pointer icon (BRG1 = single line, BRG2 = double line)
- Frequency (ADF)
- Station/waypoint identifier (NAV, GPS)
- GPS-derived great circle distance to bearing source

When the NAV radio is tuned to an ILS frequency the bearing source and the bearing pointer is removed from the HSI. When NAV1 or NAV2 is the selected bearing source, the frequency is replaced by the station identifier when the station is within range. If GPS is the bearing source, the active waypoint identifier is displayed instead of a frequency.

The bearing pointer is removed from the HSI and 'NO DATA' is displayed in the information window if the NAV radio is not receiving a VOR station or if GPS is the bearing source and an active waypoint is not selected.

**Selecting bearing display and changing sources:**

- 1) Press the **PFD** Softkey.
- 2) Press a **BRG** Softkey to display the desired bearing pointer and information window with a NAV source.
- 3) Press the **BRG** Softkey again to change the bearing source to GPS.
- 4) To remove the bearing pointer and information window, press the **BRG** Softkey again.

**DME INFORMATION WINDOW**



**NOTE:** *DME installation is optional.*

The DME Information Window is displayed above the BRG1 Information Window on the 360° HSI and in a box above and along side the Arc HSI. It shows the DME label, tuning mode (NAV1, NAV2, or HOLD), frequency, and distance. When a signal is invalid, the distance is replaced by -- NM. Refer to the Audio Panel and CNS Section for information on tuning the DMEs.

**Displaying the DME Information Window:**

- 1) Press the **PFD** Softkey.
- 2) Press the **DME** Softkey to display the DME Information Window.
- 3) To remove the DME Information Window, press the **DME** Softkey again.

## COURSE DEVIATION INDICATOR (CDI)

**NOTE:** During a heading change of greater than 105° with respect to the course, the CDI on the Arc HSI switches to the opposite side of the deviation scale and displays reverse sensing.

The Course Deviation Indicator (CDI) moves left or right from the course pointer along a lateral deviation scale to display aircraft position relative to the course. If the course deviation data is not valid, the CDI is not displayed.

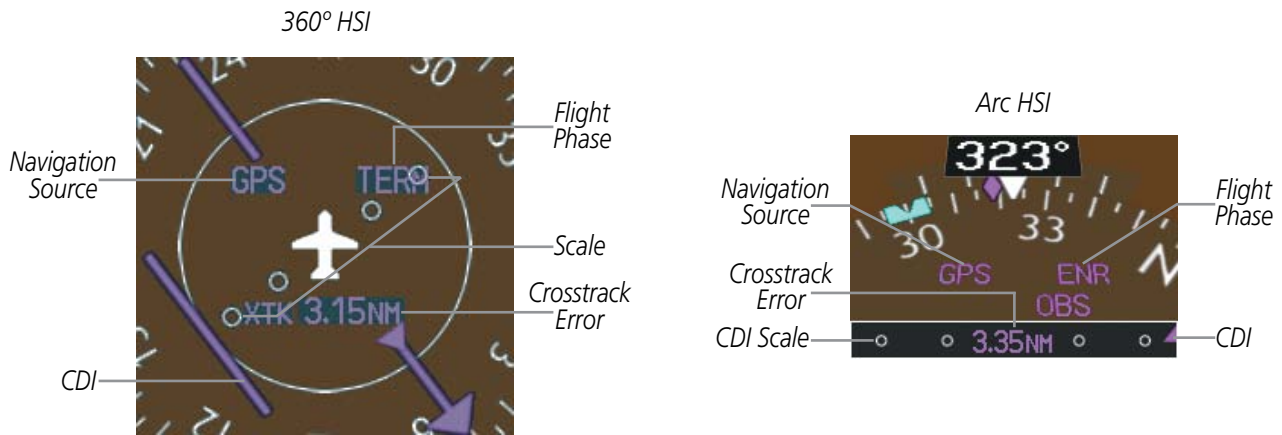

Figure 2-21 Course Deviation Indicator

The CDI can display two sources of navigation, GPS or VOR/LOC. The color indicates the current navigation source, magenta for GPS and green for VOR and LOC. The full scale limits for the CDI are defined by a GPS-derived distance when navigating GPS. When navigating using a VOR or localizer (LOC), the CDI uses the same angular deviation as a mechanical CDI. If the CDI exceeds the maximum deviation on the scale (two dots) while navigating with GPS, the crosstrack error (XTK) is displayed below the white aircraft symbol.

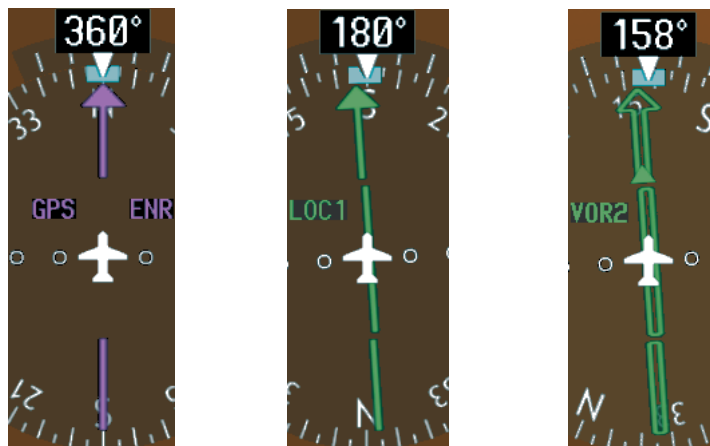

Figure 2-22 Navigation Sources



**Changing navigation sources:**

- 1) Press the **CDI** Softkey to change from GPS to VOR1 or LOC1. This places the light blue tuning box over the NAV1 standby frequency in the upper left corner of the PFD.
- 2) Press the **CDI** Softkey again to change from VOR1 or LOC1 to VOR2 or LOC2. This places the light blue tuning box over the NAV2 standby frequency.
- 3) Press the **CDI** Softkey a third time to return to GPS.



**NOTE: KAP 140 equipped aircraft only:** Each time the **CDI** Softkey is pressed or the navigation source changes, a message appears (“NAV Source Changed – Select Desired Autopilot Mode”), regardless of whether or not the autopilot is engaged.

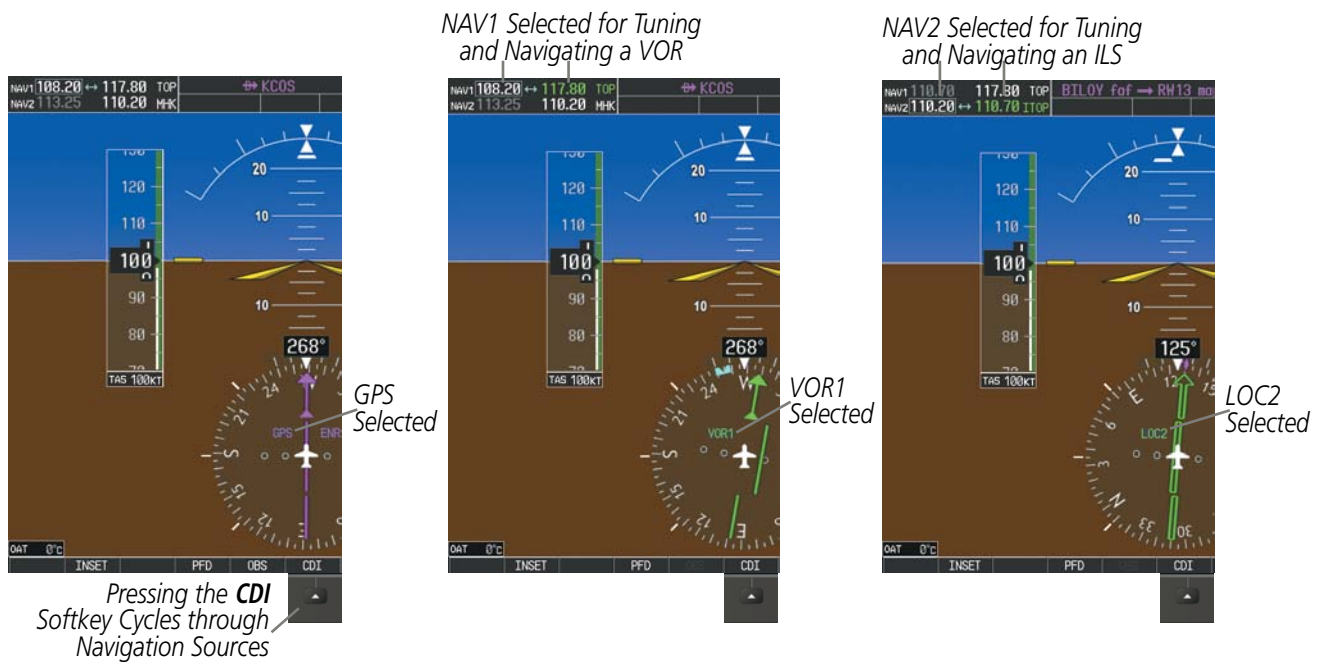

**Figure 2-23** Selecting a Navigation Source

The system automatically switches from GPS to LOC navigation source and changes the CDI scaling accordingly when all of the following occur:

- A localizer or ILS approach has been loaded into the active flight plan
- The final approach fix (FAF) is the active waypoint, the FAF is less than 15 nm away, and the aircraft is moving toward the FAF
- A valid localizer frequency has been tuned
- The GPS CDI deviation is less than 1.2 times full-scale deflection

GPS steering guidance is still provided after the CDI automatically switches to LOC until LOC capture, up to the Final Approach Fix (FAF) for an ILS approach, or until GPS information becomes invalid. Activating a Vector-to-Final (VTF; see the Flight Management Section) also causes the CDI to switch to LOC navigation source; GPS steering guidance is not provided after this switch.



## GPS CDI SCALING

When GPS is the selected navigation source, the flight plan legs are sequenced automatically and annunciations appear on the HSI for the flight phase. Flight phase annunciations are normally shown in magenta, but when cautionary conditions exist the color changes to yellow. If the current leg in the flight plan is a heading leg, HDG LEG is annunciated in magenta beneath the aircraft symbol.

The current GPS CDI scale setting is displayed as System CDI on the AUX - System Setup Page and the full-scale deflection setting may also be changed (2.0 nm, 1.0 nm, 0.3 nm, or Auto) from this page. If the selected scaling is smaller than the automatic setting for enroute and terminal phases, the CDI is scaled accordingly and the selected setting is displayed rather than the flight phase annunciation.

### Changing the selected GPS CDI setting:

- 1) Use the **FMS** Knob to select the AUX - System Setup Page on the MFD.
- 2) Press the **FMS** Knob to activate the cursor.
- 3) Turn the large **FMS** Knob to highlight Selected in the GPS CDI box.
- 4) Turn the small **FMS** Knob to highlight the desired setting and press the **ENT** Key.
- 5) To cancel the selection, press the **FMS** Knob or the **CLR** Key.



Figure 2-24 AUX - System Setup Page, GPS CDI Settings

When set to Auto (default), the GPS CDI scale automatically adjusts to the desired limits based upon the current phase of flight (Figure 2-25, Table 2-1).

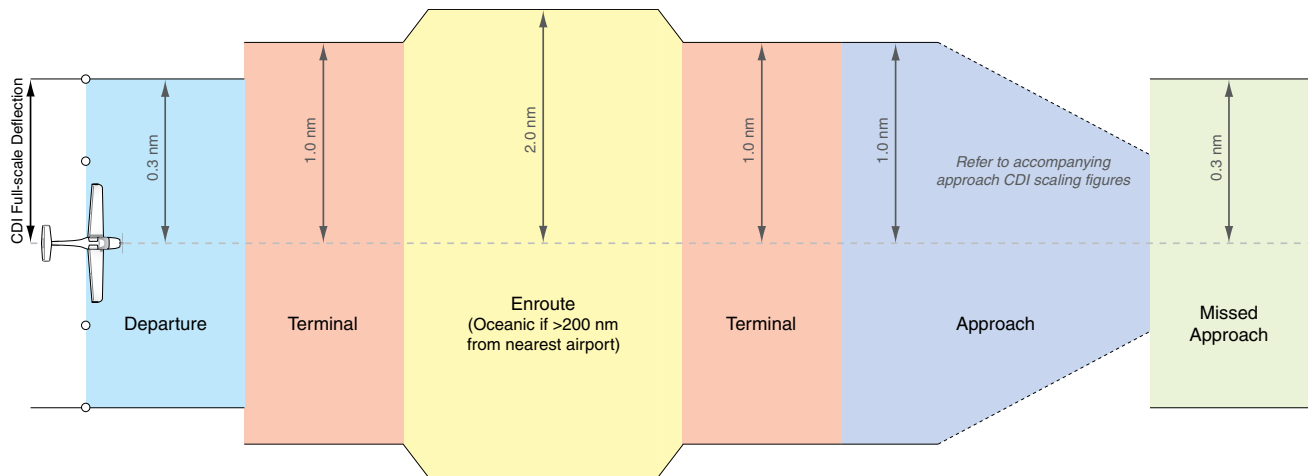

Figure 2-25 Automatic CDI Scaling

- Once a departure procedure is activated, the CDI is scaled for **departure** (0.3 nm).
- The system switches from departure to **terminal** CDI scaling (1.0 nm) under the following conditions:
  - The next leg in the procedure is not aligned with the departure runway
  - The next leg in the departure procedure is not CA, CD, CF, CI, CR, DF, FA, FC, FD, FM, IF, or TF (see Glossary for leg type definitions)
  - After any leg in the departure procedure that is not CA or FA
- At 30 nm from the departure airport the **enroute** phase of flight is automatically entered and CDI scaling changes to 2.0 nm over a distance of 1.0 nm, except under the following conditions:
  - When navigating with an active departure procedure, the flight phase and CDI scale does not change until the aircraft arrives at the last departure waypoint (if more than 30 nm from the departure airport) or the leg after the last departure waypoint has been activated or a direct-to waypoint is activated.
- If after completing the departure procedure the nearest airport is more than 200 nm away from the aircraft and the approach procedure has not yet commenced, the CDI is scaled for **oceanic** flight (2.0 nm).
- Within 31 nm of the destination airport (**terminal** area), the CDI scale gradually ramps down from 2.0 nm to 1.0 nm over a distance of 1.0 nm, except under the following conditions:
  - Upon reaching the first waypoint of an arrival route that is more than 31 nm from the destination airport, the flight phase changes to terminal and the CDI scale begins to transition down from 2.0 nm to 1.0 nm over a distance of 1.0 nm.
- During **approach**, the CDI scale ramps down even further (see Figures 2-26 and 2-27). This transition normally occurs within 2.0 nm of the final approach fix (FAF). The CDI switches to approach scaling automatically once the approach procedure is activated or if Vector-to-Final (VTF) is selected.
  - If the active waypoint is the FAF, the ground track and the bearing to the FAF must be within 45° of the final approach segment course.

- If the active waypoint is part of the missed approach procedure, the active leg and preceding missed approach legs must be aligned with the final approach segment course and the aircraft must not have passed the turn initiation point.

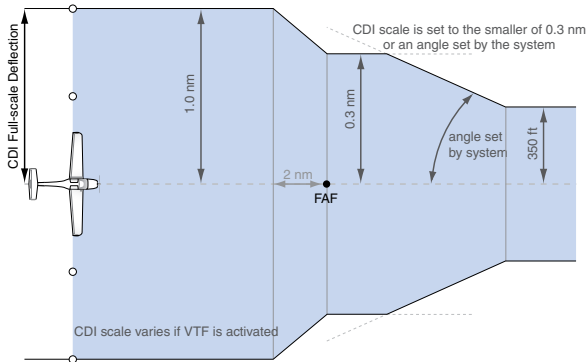

Figure 2-26 Typical LNAV and LNAV+V Approach CDI Scaling

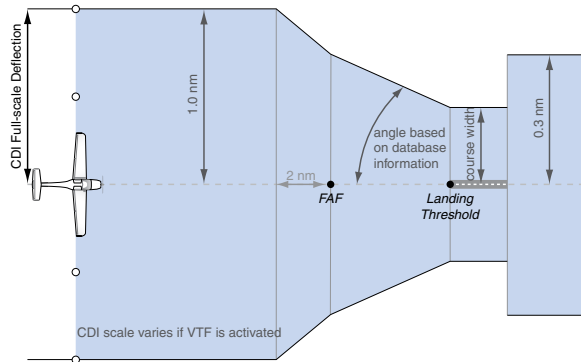

Figure 2-27 Typical LNAV/VNAV and LPV Approach CDI Scaling

- When a **missed approach** is activated, the CDI scale changes to 0.3 nm.
- The system automatically switches back to **terminal** scaling under the following conditions:
  - The next leg in the missed approach procedure is not aligned with the final approach path
  - The next leg in the missed approach procedure is not CA, CD, CF, CI, CR, DF, FA, FC, FD, FM, IF, or TF
  - After any leg in the missed approach procedure that is not CA or FA

Flight Phase	Annunciation	Automatic CDI Full-scale Deflection
Departure	DPRT	0.3 nm
Terminal	TERM	1.0 nm
Enroute	ENR	2.0 nm
Oceanic	OCN	2.0 nm
Approach (Non-precision)	LNAV	1.0 nm decreasing to 350 feet depending on variables (see Figure 2-26)
Approach (Non-precision with Vertical Guidance)	LNAV + V	
Approach (LNAV/VNAV)	L/VNAV	1.0 nm decreasing to a specified course width, then 0.3 nm, depending on variables (see Figure 2-27)
Approach (LPV)	LPV	
Missed Approach	MAPR	0.3 nm

Table 2-1 Automatic GPS CDI Scaling

OBS MODE



**NOTE:** VNV is inhibited while automatic waypoint sequencing has been suspended.

Enabling Omni-bearing Selector (OBS) Mode suspends the automatic sequencing of waypoints in a GPS flight plan (GPS must be the selected navigation source), but retains the current Active-to waypoint as the navigation reference even after passing the waypoint. OBS is annunciated to the lower right of the aircraft symbol on the moving map when OBS Mode is selected.

While OBS is enabled, a course line is drawn through the Active-to waypoint on the moving map. If desired, the course to/from the waypoint can now be adjusted. When OBS Mode is disabled, the GPS flight plan returns to normal operation, with automatic sequencing of waypoints, following the course set in OBS Mode. The flight plan on the moving map retains the modified course line.

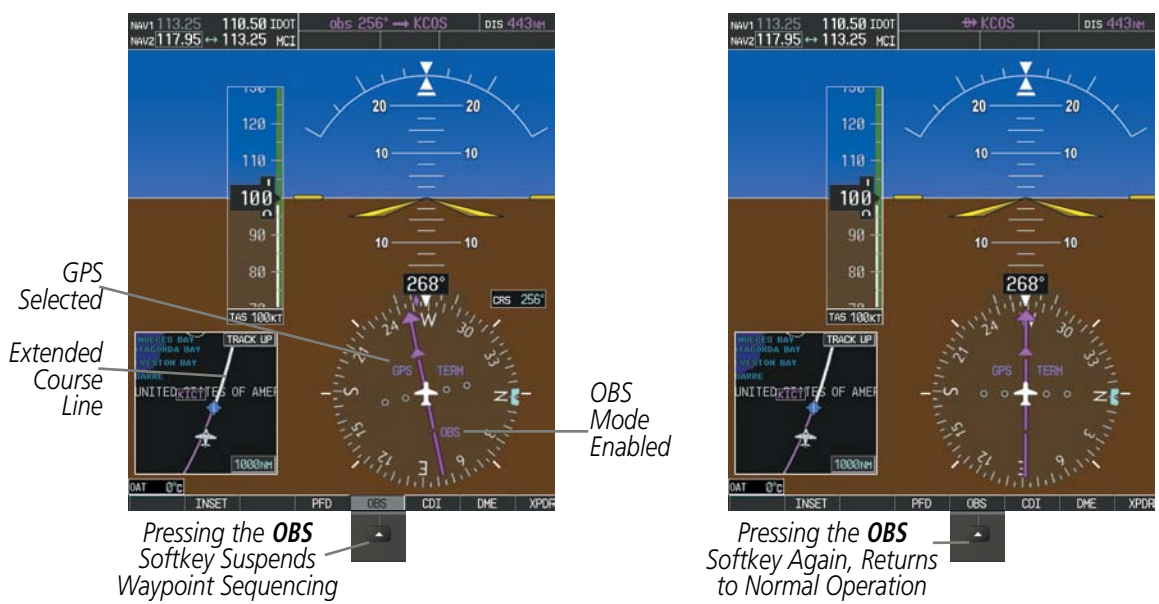

Figure 2-28 Omni-bearing Selector (OBS) Mode

**Enabling/disabling OBS Mode while navigating a GPS flight plan:**

- 1) Press the **OBS** Softkey to select OBS Mode.
- 2) Turn the **CRS** Knob to select the desired course to/from the waypoint. Press the **CRS** Knob to synchronize the Selected Course with the bearing to the next waypoint.
- 3) Press the **OBS** Softkey again to return to automatic waypoint sequencing.

As the aircraft crosses the missed approach point (MAP), automatic approach waypoint sequencing is suspended. **SUSP** appears on the HSI at the lower right of the aircraft symbol in place of **OBS** and the **OBS** Softkey label changes to **SUSP**. Pressing the **SUSP** Softkey resumes automatic sequencing of approach waypoints.



Figure 2-29 Suspending Automatic Waypoint Sequencing

## 2.2 SUPPLEMENTAL FLIGHT DATA



**NOTE:** Pressing the *DFLTS* Softkey turns off metric Altimeter display, the Inset Map and wind data display.

In addition to the flight instruments, the PFD also displays various supplemental information, including temperatures, wind data, and Vertical Navigation (VNV) indications.

### OUTSIDE AIR TEMPERATURE

The Outside Air Temperature (OAT) is displayed in degrees Celsius (°C) or Fahrenheit (°F) as selected by the pilot, in the lower left of the PFD under normal display conditions. Temperature is displayed below the true airspeed in reversionary mode.

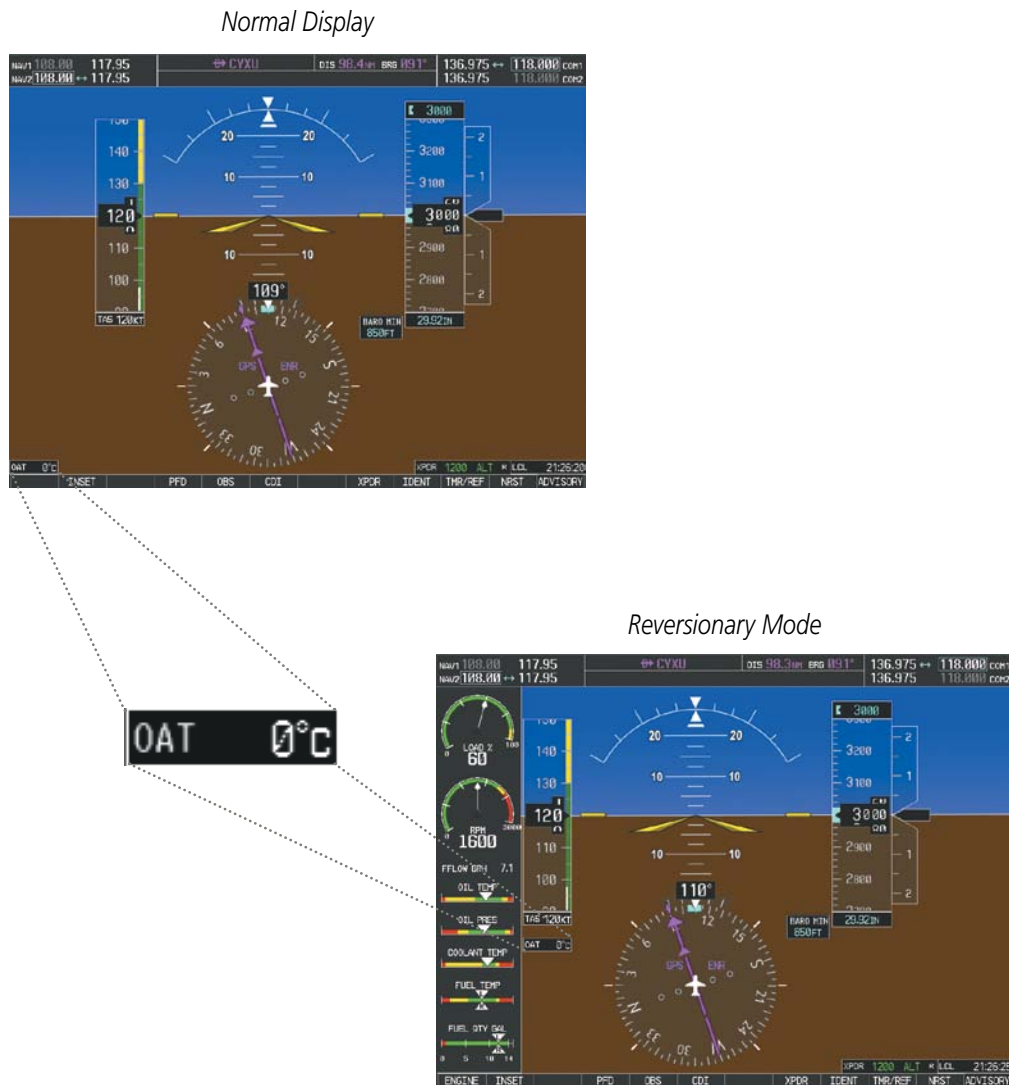

Figure 2-30 Outside Air Temperature

**Changing temperature display units:**

- 1) Select the AUX - System Setup Page on the MFD using the **FMS** Knob.
- 2) Press the **FMS** Knob to activate the cursor.
- 3) Turn the large **FMS** Knob to highlight the TEMP field in the Display Units box.
- 4) Turn the small **FMS** Knob to highlight either CELSIUS or FAHRENHEIT and press the **ENT** Key to confirm the selection.
- 5) To cancel the selection, press the **FMS** Knob or the **CLR** Key.

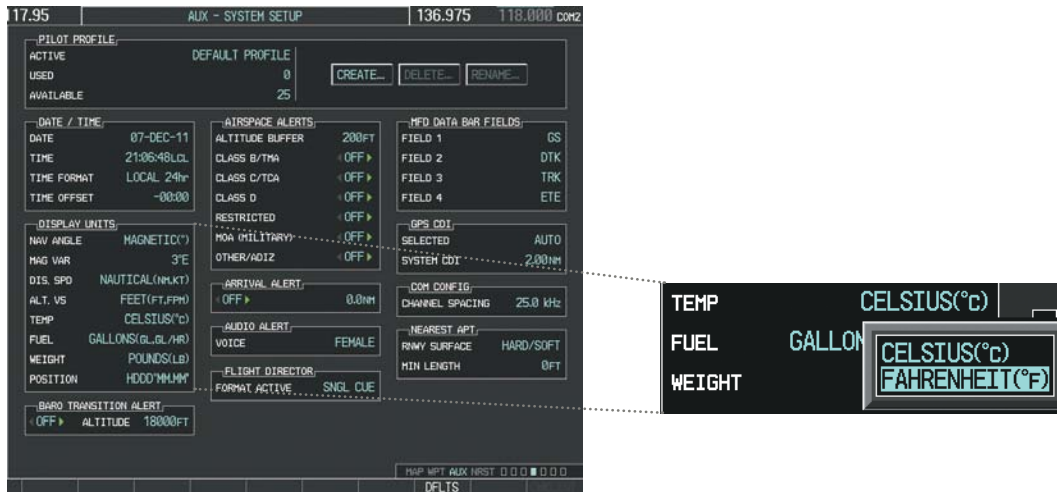

Figure 2-31 AUX - System Setup Page, Temperature Selection



## WIND DATA

Wind direction and speed in knots can be displayed relative to the aircraft in a window to the upper left of the HSI. When the window is selected for display, but wind information is invalid or unavailable, the window displays 'NO WIND DATA'. Wind data can be displayed in three different ways.

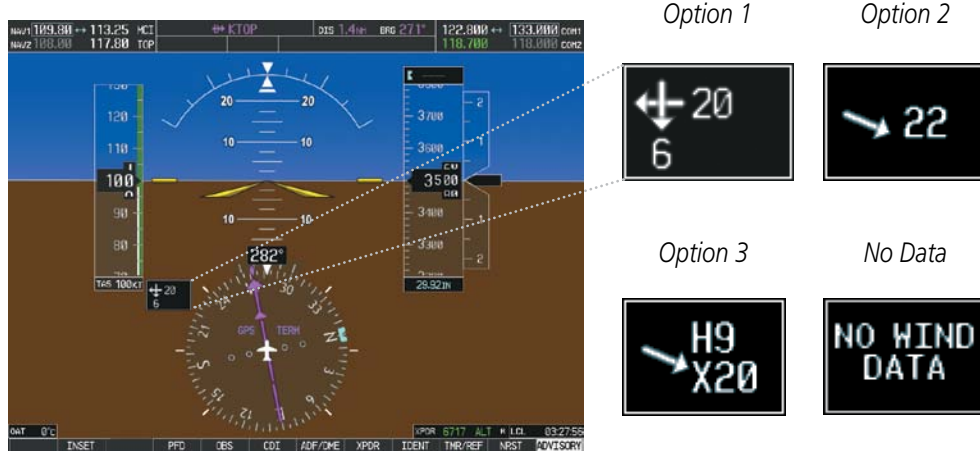

Figure 2-32 Wind Data

### Displaying wind data:

- 1) Press the **PFD** Softkey.
- 2) Press the **WIND** Softkey to display wind data below the Selected Heading.
- 3) Press one of the **OPTN** softkeys to change how wind data is displayed:
  - **OPTN 1:** Headwind and crosswind components
  - **OPTN 2:** Total wind direction and speed
  - **OPTN 3:** Total wind direction with headwind (H) or tailwind (T), and crosswind (X) speed components
- 4) To remove the window, press the **OFF** Softkey.

## VERTICAL NAVIGATION (VNV) INDICATIONS

When a VNV flight plan has been activated, VNV indications (VNV Target Altitude, RVSI, VDI) appear on the PFD in conjunction with the “TOD within 1 minute” message and “Vertical track” voice alert. See the Flight Management and AFCS sections for details on VNV features. VNV indications are removed from the PFD according to the criteria listed in the table.



Figure 2-33 Vertical Navigation Indications (PFD)

Criteria	VNV Indication Removed		
	Required Vertical Speed (RVSI)	Vertical Deviation (VDI)	VNV Target Altitude
Aircraft > 1 min before the next TOD and not on a descent leg	X	X	X
Aircraft > 1 min before the next TOD due to flight plan change	X	X	X
VNV cancelled ( <b>CNCL VNV</b> Softkey selected on MFD)	X	X	X
Distance to active waypoint cannot be computed due to unsupported flight plan leg type (see Flight Management Section)	X	X	X
Aircraft > 250 feet below active VNV Target Altitude	X	X	X
Current crosstrack or track angle error has exceeded limit	X	X	X
Active altitude-constrained waypoint can not be reached within maximum allowed flight path angle and vertical speed	X	X	
Last altitude-constrained waypoint in active flight plan reached	X	X (30 sec before)	X

Table 2-2 VNV Indication Removal Criteria

## 2.3 PFD ANNUNCIATIONS AND ALERTING FUNCTIONS

The following annunciations and alerting functions are displayed on the PFD. Refer to Appendix A for more information on alerts and annunciations.

### SYSTEM ALERTING

Messages appear in the Alerts Window in the lower right corner of the PFD when a warning, caution, advisory alert, or G1000 message advisory occurs. System alert messages are provided for awareness of G1000 system problems or status and may or may not require pilot action. The Alerts Window allows system alerts to be displayed simultaneously. The **FMS** Knob is used to scroll through the alert messages. The Alerts Window is enabled/disabled by pressing the **ALERTS** Softkey. If the window is already open when a new message is generated, pressing the **ALERTS** Softkey to acknowledge the message turns the softkey gray.

The **ALERTS** Softkey label changes to display the appropriate annunciation when an alert is issued. The annunciation flashes and the appropriate aural alert sounds until acknowledged by pressing the softkey. The softkey then reverts to the **ALERTS** label, and when pressed again opens the Alerts Window to display a descriptive message of the alert.

Caution indicates the existence of abnormal conditions on the aircraft that may require pilot intervention. A flashing **CAUTION** Softkey annunciation and single aural tone (one chime) indicate the presence of a caution. The flashing **CAUTION** Softkey annunciation continues to flash until acknowledged by pressing the **CAUTION** Softkey.

Warnings are time-critical and require immediate attention. A flashing **WARNING** Softkey annunciation and aural tone (single chime every two seconds) indicate the presence of a warning. The aural tone and flashing **WARNING** Softkey annunciation continue until acknowledged by pressing the **WARNING** Softkey.

The Annunciation Window appears to the right of the Vertical Speed Indicator and displays abbreviated annunciation text for aircraft alerts. Warnings appear in red, cautions in yellow, advisory alerts in white, and safe operating annunciations in green. New alerts are displayed at the top of the Annunciation Window, regardless of priority. Once acknowledged, they are sequenced based on priority.

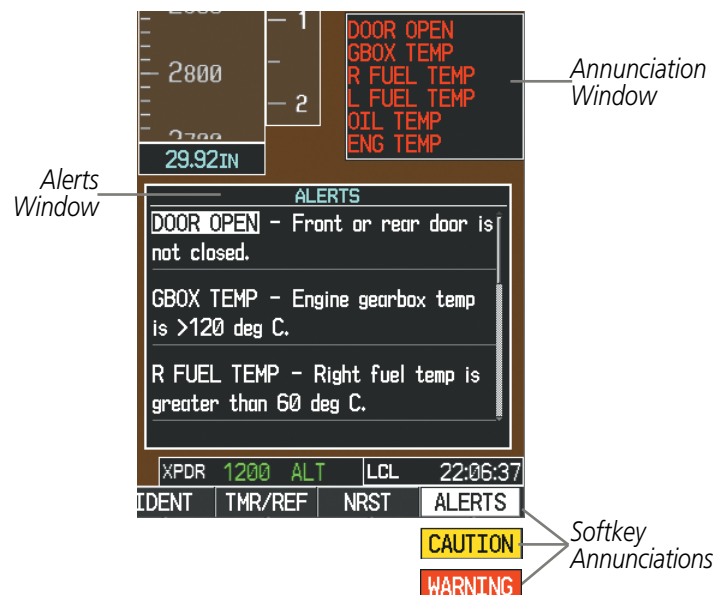

Figure 2-34 G1000 Alerting System

## MARKER BEACON ANNUNCIATIONS

Marker Beacon Annunciations are displayed on the PFD to the left of the Selected Altitude. Outer marker reception is indicated in blue, middle in yellow, and inner in white. Refer to the Audio Panel and CNS Section for more information on Marker Beacon Annunciations.

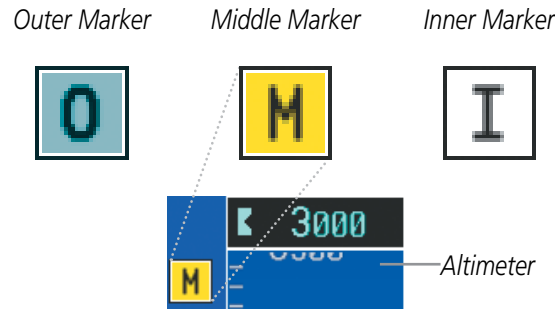

Figure 2-35 Marker Beacon Annunciations

## TRAFFIC ANNUNCIATION

Traffic is displayed symbolically on the PFD Inset Map, the MFD Navigation Map Page, and various other MFD page maps. Refer to the Hazard Avoidance Section and Appendix F for more details about the Traffic Information Service (TIS) and optional Traffic Advisory Systems (TAS). When a traffic advisory (TA) is detected, the following automatically occur:

- The PFD Inset Map is enabled and displays traffic
- A flashing black-on-yellow TRAFFIC annunciation appears to the top left of the Attitude Indicator for five seconds and remains displayed until no TAs are detected in the area
- A single “TRAFFIC” aural alert is heard, unless an optional Traffic Advisory System (TAS) is installed. Refer to the applicable TAS documentation for alerts generated by TAS equipment.

If additional TAs appear, new aural and visual alerts are generated.

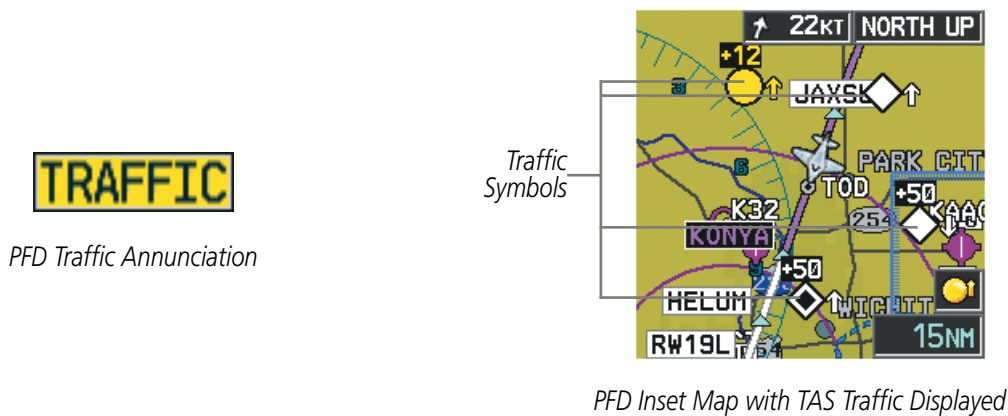

Figure 2-36 Traffic Annunciation and Inset Map with Traffic Displayed

## TERRAIN ANNUNCIATIONS

Terrain-SVS annunciations appear on the PFD at the top left of the Altimeter when the SVS option is installed. Refer to the Hazard Avoidance Section and Appendix A for information on Terrain-SVS alerts and annunciations.



Figure 2-37 TERRAIN-SVS Annunciation

## ALTITUDE ALERTING

Altitude Alerting provides the pilot with a visual alert when approaching the Selected Altitude. Whenever the Selected Altitude is changed, the Altitude Alerter is reset. The Altitude Alerter is independent of the GFC 700 AFCS, but alerting tones and visual alerts only occur if the GFC 700 is installed. The following occur when approaching the Selected Altitude:

- Upon passing through 1000 feet of the Selected Altitude, the Selected Altitude display changes to black text on a light blue background and flashes for 5 seconds.
- When the aircraft passes within 200 feet of the Selected Altitude, the Selected Altitude display changes to light blue text on a black background and flashes for 5 seconds.
- After reaching the Selected Altitude, if the pilot flies outside the deviation band ( $\pm 200$  feet of the Selected Altitude), the Selected Altitude changes to yellow text on a black background and flashes for 5 seconds.



Figure 2-38 Altitude Alerting Visual Annunciations

## LOW ALTITUDE ANNUNCIATION



**NOTE:** A Low Altitude Annunciation is available only when SBAS is available. This annunciation is not shown for systems equipped with Terrain-SVS, unless Terrain-SVS is inhibited.

When the Final Approach Fix (FAF) is the active waypoint in a GPS SBAS approach using vertical guidance, a Low Altitude Annunciation may appear if the current aircraft altitude is at least 164 feet below the prescribed altitude at the FAF. A black-on-yellow LOW ALT annunciation appears to the top left of the Altimeter, flashing for several seconds, then remaining displayed until the condition is resolved.

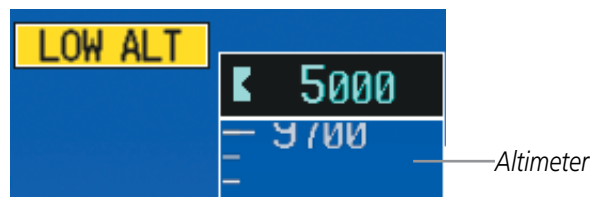

Figure 2-39 Low Altitude on GPS SBAS Approach

## MINIMUM DESCENT ALTITUDE/DECISION HEIGHT ALERTING

For altitude awareness, a barometric Minimum Descent Altitude (MDA) or Decision Height (DH) can be set in the Timer/References Window and is reset when the power is cycled. When active, the altitude setting is displayed to the bottom left of the Altimeter. Once the altitude is within the range of the tape, a bug appears at the reference altitude on the Altimeter. The following visual annunciations occur when approaching the MDA/DH:

- When the aircraft altitude descends to within 2500 feet of the MDA/DH setting, the BARO MIN box appears with the altitude in light blue text. The bug appears on the altitude tape in light blue once in range.
- When the aircraft passes through 100 feet of the MDA/DH, the bug and text turn white.
- Once the aircraft reaches MDA/DH, the bug and text turn yellow and the aural alert, “Minimums. Minimums”, is heard.

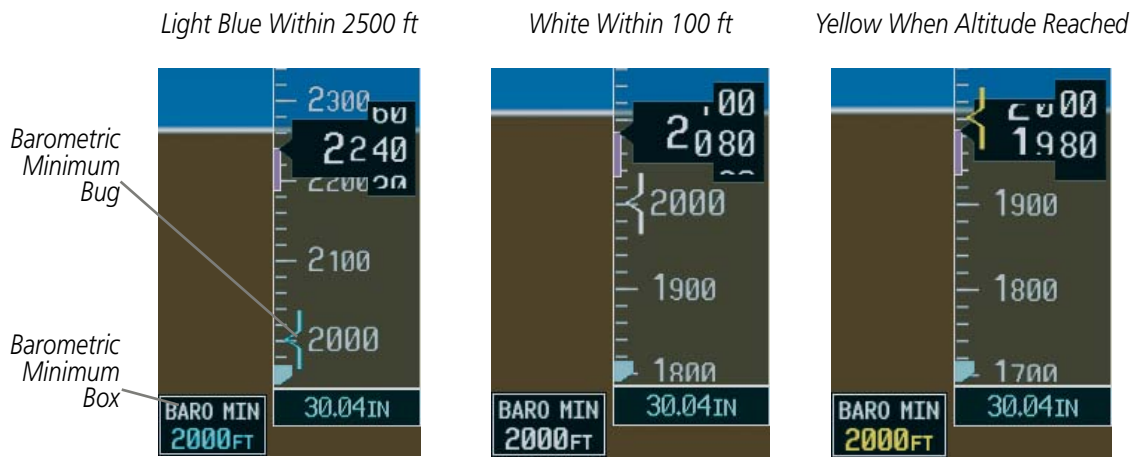

Figure 2-40 Barometric MDA/DH Alerting Visual Annunciations

### Setting the barometric Minimum Descent Altitude/Decision Height and bug:

- 1) Press the **TMR/REF** Softkey.
- 2) Turn the large **FMS** Knob to highlight the Minimums field.
- 3) Turn the small **FMS** Knob to select BARO. Off is selected by default. Press the **ENT** Key or turn the large **FMS** Knob to highlight the next field.
- 4) Use the small **FMS** Knob to enter the desired altitude from zero to 16,000 feet.
- 5) To remove the window, press the **CLR** Key or the **TMR/REF** Softkey.



Figure 2-41 Barometric MDA/DH

Alerting is inhibited while the aircraft is on the ground and until the aircraft reaches 150 feet above the MDA. If the aircraft proceeds to climb after having reached the MDA, once it reaches 50 feet above the MDA, alerting is disabled.



## 2.4 ABNORMAL OPERATIONS

### ABNORMAL GPS CONDITIONS

The annunciations listed in the table can appear on the HSI when abnormal GPS conditions occur. Refer to the Flight Management Section for more information on Dead Reckoning (DR) Mode.

Annunciation	Location	Description
LOI	Lower left of aircraft symbol	Loss of Integrity Monitoring—GPS integrity is insufficient for the current phase of flight
INTEG OK	Lower left of aircraft symbol	Integrity OK—GPS integrity has been restored to within normal limits (annunciation displayed for 5 seconds)
DR	Upper right of aircraft symbol and PFD Inset Map	Dead Reckoning—System is using projected position rather than GPS position to compute navigation data and sequence active flight plan waypoints

Table 2-3 Abnormal GPS Conditions Annunciated on HSI



Figure 2-42 Example HSI Annunciations

In DR Mode the CDI is removed from the display when GPS is the selected navigation source. In addition, all GPS-derived data is computed based upon an estimated position and is displayed as yellow text on the display to denote degraded navigation source information. This data includes the following:

- Navigation Status Box fields except Active Leg, TAS, and DTK
- GPS Bearing Pointer
- Wind data and pointers in the Wind Data Box on the PFD
- Track Indicator
- All Bearing Pointer Distances
- Active Flight Plan distances, bearings, and ETE values

These items should be verified when operating in Dead Reckoning Mode.

Also, while the G1000 is in DR Mode, the autopilot will not couple to GPS, and TERRAIN-SVS alerts (if installed) will not be issued. Additionally, the accuracy of all nearest information (airports, airspaces, and waypoints) is questionable. Finally, airspace alerts continue to function, but with degraded accuracy.

## UNUSUAL ATTITUDES

When the aircraft enters an unusual pitch attitude, red chevrons pointing toward the horizon warn of extreme pitch. The chevrons are displayed on the Attitude Indicator, starting at 50° above and 30° below the horizon line.

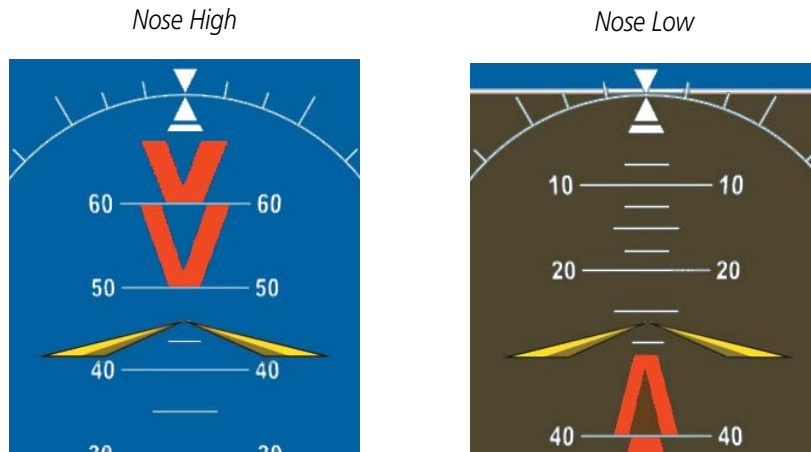

Figure 2-43 Pitch Attitude Warnings

If pitch exceeds +30°/-20° or bank exceeds 65°, some information displayed on the PFD is removed. The Altimeter and Airspeed, Attitude, Vertical Speed, and Horizontal Situation indicators remain on the display and the Bearing Information, Alerts, and Annunciation windows can be displayed during such situations. The following information is removed from the PFD and their softkeys are disabled when the aircraft experiences unusual attitudes:

- Traffic Annunciations
- AFCS Annunciations
- Flight director Command Bars
- Inset Map
- Outside air temperature (OAT)
- DME Information Window
- Wind data
- Transponder Status Box
- System Time
- PFD Setup Menu
- Windows displayed in the lower right corner of the PFD:
  - Timer/References
  - Nearest Airports
  - Flight Plan
  - Alerts
  - Procedures
  - ADF/DME Tuning
- Minimum Descent Altitude/ Decision Height readout
- Vertical Deviation, Glideslope, and Glidepath Indicators
- Altimeter Barometric Setting
- Selected Altitude
- VNV Target Altitude

SYSTEM  
OVERVIEW

FLIGHT  
INSTRUMENTS

EIS

AUDIO PANEL  
& CNS

FLIGHT  
MANAGEMENT

HAZARD  
AVOIDANCE

AFCS

ADDITIONAL  
FEATURES

APPENDICES

INDEX

BLANK PAGE

## SECTION 3 ENGINE INDICATION SYSTEM



**NOTE:** Refer to the Airplane Flight Manual (AFM) for limitations.

The G1000 Engine Indication System (EIS) for the Diamond DA40NG displays critical engine, electrical, fuel, and other system parameters. The EIS information is displayed on the left side of the Multi Function Display (MFD) during normal operations (Figure 3-1). In Reversionary Mode, the display combines Primary Flight Display (PFD) symbology with the EIS (refer to the System Overview for information about Reversionary Mode).



Figure 3-1 MFD

EIS information is presented in three displays, accessed using the **ENGINE** Softkey on the MFD:

- **Engine Display** – Default display; shows all critical engine and fuel indicators
- **System Display** – Displays electrical, oil, and additional engine indicators
- **Fuel Display** – Shows numeric readouts for the fuel indicators and fuel calculations

The Engine Load Gauge and Tachometer are shown at the top of all three displays.

Instrument types include dial gauges, horizontal bar indicators, and digital readouts. Green bands indicate normal ranges of operation; yellow and red bands indicate cautions and warnings, respectively. Readouts, labels, and pointers indicators appear in white to indicate normal operation and may change to yellow or red to indicate caution or warning conditions. If sensory data to an instrument becomes invalid or unavailable, a red “X” is displayed across the instrument. If sensory data to a readout are out-of-range, dashes are displayed instead of a readout.

### 3.1 ENGINE DISPLAY

The Engine Display is the default EIS display and can be selected by pressing the **ENGINE** or **BACK** Softkey when another EIS display is currently shown. Beneath the dial gauges and fuel flow readout are horizontal bar indicators for oil temperature, oil pressure, coolant temperature, and fuel quantity.

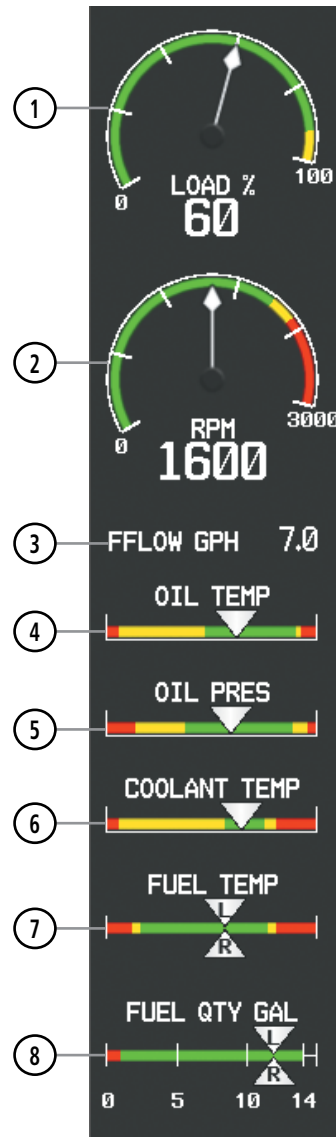

Figure 3-2 Engine Display

- ① **Engine Load Gauge (LOAD %)** Displays current engine load as a percentage
- ② **Tachometer (RPM)** Displays propeller speed information in revolutions per minute (rpm)  
Red band indicates propeller overspeed (readout also flashes red)
- ③ **Fuel Flow (FFLOW GPH)** Displays current fuel flow in gallons per hour (gph)
- ④ **Oil Temperature Indicator (OIL TEMP)** Displays engine oil temperature
- ⑤ **Oil Pressure Indicator (OIL PRES)** Displays pressure of oil supplied to the engine
- ⑥ **Coolant Temperature Indicator (COOLANT TEMP)** Displays the engine coolant temperature
- ⑦ **Fuel Temperature Indicator (FUEL TEMP)** Displays the temperature of the fuel for each tank; pointers labeled L and R indicate the fuel temperature for each tank
- ⑧ **Fuel Quantity Indicator (FUEL QTY GAL)** Displays the quantity, in gallons (gal), of fuel in the tanks; pointers labeled L and R indicate the fuel quantity in each tank  
Indicator ranges from 0 to 15 gal with tick marks every 5 gal; only displays to 14 gal per side when full

### 3.2 SYSTEM DISPLAY

The System Page is accessed by pressing the **ENGINE** Softkey followed by the **SYSTEM** Softkey. The indications for this page are separated into three categories: Electrical, Engine, and Oil. Beneath the tachometer are horizontal bar indicators for bus voltage, alternator load, and gearbox temperature, followed by digital readouts for coolant temperature, oil temperature, and oil pressure.

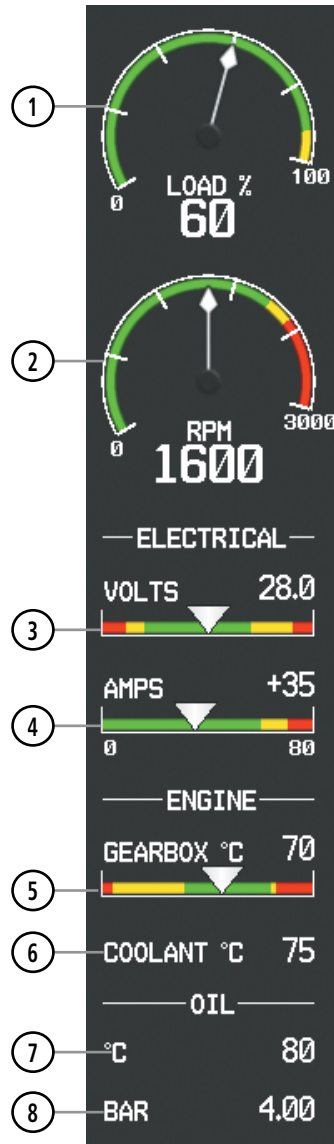

Figure 3-3 System Display

- SYSTEM OVERVIEW
- FLIGHT INSTRUMENTS
- EIS
- AUDIO PANEL & CNS
- FLIGHT MANAGEMENT
- HAZARD AVOIDANCE
- AFCS
- ADDITIONAL FEATURES
- APPENDICES
- INDEX



- |   |   |   |
|---|---|---|
| ① | <b>Engine Load Gauge (LOAD %)</b>                 | Displays current engine load as a percentage  |
| ② | <b>Tachometer (RPM)</b>                           | Displays propeller speed information in revolutions per minute (rpm)<br>Red band indicates propeller overspeed (readout also flashes red) |
| ③ | <b>Voltmeter (VOLTS)</b>                          | Displays the primary bus voltage  |
| ④ | <b>Ammeter (AMPS)</b>                             | Displays alternator load in amperes (amps)  |
| ⑤ | <b>Gearbox Temperature Indicator (GEARBOX °C)</b> | Displays the gearbox temperature in degrees Celsius (°C)  |
| ⑥ | <b>Coolant Temperature (COOLANT °C)</b>           | Displays the engine coolant temperature in °C   |
| ⑦ | <b>Oil Temperature (°C)</b>                       | Displays engine oil temperature in °C   |
| ⑧ | <b>Oil Pressure (BAR)</b>                         | Displays pressure of oil supplied to the engine in bars   |

### Accessing the EIS System Display:

- 1) Press the **ENGINE** Softkey.
- 2) Press the **SYSTEM** Softkey.
- 3) To return to the default Engine Display, press the **ENGINE** or **BACK** Softkey.

### 3.3 FUEL DISPLAY

**NOTE:** Fuel calculations do not use the aircraft fuel quantity indicators and are calculated from the last time the fuel was reset.

**NOTE:** Refer to the Airplane Flight Manual (AFM) for limitations.

The Fuel Page is accessed by pressing the **ENGINE** Softkey followed by the **FUEL** Softkey. The readouts presented here, in addition to the dial gauges, are separated into two categories: Fuel and Fuel Calculation. The Fuel Page also displays the Total Time in Service.

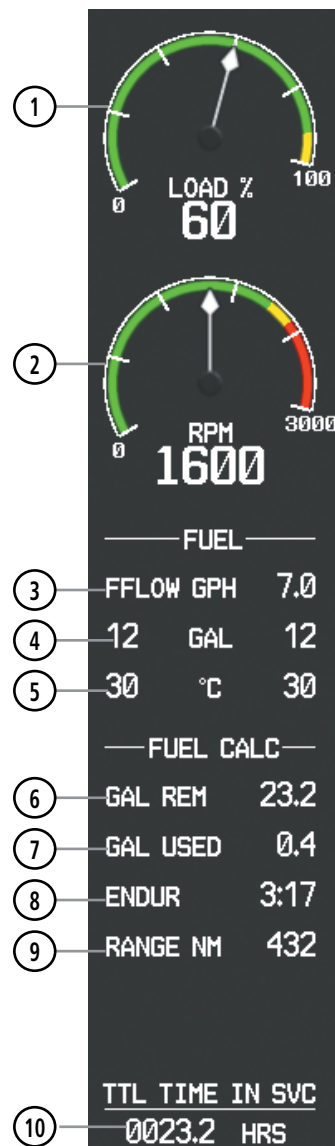

Figure 3-4 Fuel Display

- |   |  |   |
|---|--|---|
| ① | <b>Engine Load Gauge (LOAD %)</b>              | Displays current engine load as a percentage  |
| ② | <b>Tachometer (RPM)</b>                        | Displays propeller speed information in revolutions per minute (rpm)<br>Red band indicates propeller overspeed (readout also flashes red) |
| ③ | <b>Fuel Flow (FFLOW GPH)</b>                   | Displays current fuel flow in gallons per hour (gph)  |
| ④ | <b>Fuel Quantity (GAL)</b>                     | Displays the quantity, in gallons (gal), of fuel in the tanks; displays to 14 gal per side when full                                      |
| ⑤ | <b>Fuel Temperature (°C)</b>                   | Displays the temperature of the fuel for each tank  |
| ⑥ | <b>Fuel Remaining (GAL REM)</b>                | Displays current fuel remaining in gallons as set by the pilot and adjusted for fuel burn since last set                                  |
| ⑦ | <b>Fuel Used (GAL USED)</b>                    | Displays quantity of fuel used in gallons   |
| ⑧ | <b>Endurance (ENDUR)</b>                       | Displays flight time remaining with fuel onboard (HH:MM when more than an hour remains)   |
| ⑨ | <b>Range (RANGE NM)</b>                        | Displays aircraft range in nautical miles   |
| ⑩ | <b>Total Time in Service (TTL TIME IN SVC)</b> | Displays the aircraft's total flight hours (hrs); activated when the aircraft becomes airborne  |

Fuel calculations are based on the displayed fuel remaining (GAL REM) and the fuel flow totalizer. The fuel remaining can be adjusted using the following softkeys:

- **DEC FUEL** – Decreases totalizer-based fuel remaining in one-gallon increments
- **INC FUEL** – Increases totalizer-based fuel remaining in one-gallon increments
- **RST FUEL** – Resets totalizer-based fuel remaining (GAL REM) relative to the aircraft's fuel capacity and sets the displayed fuel used (GAL USED) to zero

**Accessing the EIS Fuel Display:**

- 1) Press the **FUEL** Softkey.
- 2) Press the **SYSTEM** Softkey.
- 3) To return to the default Engine Display, press the **ENGINE** or **BACK** Softkey.

**Adjusting the fuel totalizer quantity:**

From the System Display, press the **DEC FUEL** or **INC FUEL** Softkey to change the fuel remaining (GAL REM).

**Resetting the fuel totalizer and displayed fuel remaining (GAL REM):**

From the System Display, press the **RST FUEL** Softkey.

### 3.4 EIS DISPLAY IN REVERSIONARY MODE

In Reversionary Mode (Figure 3-5), the display presents PFD symbology with the EIS Display (refer to the System Overview for information about display Reversionary Mode).

When the G1000 displays enter reversionary mode, the EIS is separated into three displays (identical to the normal EIS Display on the MFD): Engine, System, and Fuel. For a description of each display, refer to Section 3.1, 3.2 and 3.3 respectively.



Figure 3-5 Reversionary Mode

The Engine Display is shown by default. To return to the Engine Display from the System or Fuel Display, press the **ENGINE** or **BACK** Softkey.

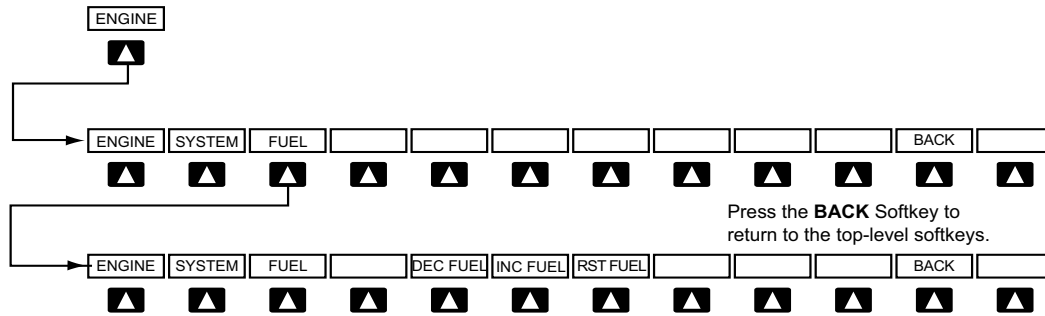

**Figure 3-6 EIS Softkeys (Reversionary Mode)**

<b>ENGINE</b>	Displays the EIS Engine Display and softkeys
<b>SYSTEM</b>	Displays the EIS System Display
<b>FUEL</b>	Displays the EIS Fuel Display and softkeys
<b>DEC FUEL</b>	Decreases displayed fuel remaining in 1-gal increments. Softkey shown when System Display is enabled.
<b>INC FUEL</b>	Increases displayed fuel remaining in 1-gal increments. Softkey shown when System Display is enabled.
<b>RST FUEL</b>	Resets displayed fuel remaining to maximum fuel capacity for aircraft and fuel used to zero. Softkey shown when System Display is enabled.
<b>BACK</b>	Returns to the top-level Reversionary Mode softkeys

SYSTEM  
OVERVIEW

FLIGHT  
INSTRUMENTS

**EIS**

AUDIO PANEL  
& CNS

FLIGHT  
MANAGEMENT

HAZARD  
AVOIDANCE

AFCS

ADDITIONAL  
FEATURES

APPENDICES

INDEX

**BLANK PAGE**

## SECTION 4 AUDIO PANEL AND CNS

### 4.1 OVERVIEW

The Communication/Navigation/Surveillance (CNS) system includes the Audio Panel, communication radios, navigation radios, and Mode S transponder. The System Overview Section provides a block diagram description of the Audio Panel and CNS system interconnection.

CNS operation in Diamond DA40NG aircraft is performed by the following Line Replaceable Units (LRUs):

- Primary Flight Display (PFD)
- Multifunction Display (MFD)
- Integrated Avionics Unit (2)
- Audio Panel
- Mode S Transponder

The MFD/PFD controls are used to tune the communication transceivers and navigation radios.

The Audio Panel provides the traditional audio selector functions of microphone and receiver audio selection. The Audio Panel includes an intercom system (ICS) between the pilot, copilot, and passengers, a marker beacon receiver, and a COM clearance recorder. Ambient noise from the aircraft radios is reduced by a feature called Master Avionics Squelch (MASQ). When no audio is detected, MASQ processing further reduces the amount of background noise from the radios.

The Mode S transponder is controlled with softkeys and the **FMS** Knob located on the Primary Flight Display (PFD). The Transponder Data Box is located to the left of the System Time Box. The data box displays the active four-digit code, mode, and reply status (Figure 4-1).



MFD/PFD CONTROLS AND FREQUENCY DISPLAY



Figure 4-1 MFD/PFD Controls, COM/NAV Frequency Tuning Boxes, and ADF/DME Tuning Window (PFD Shown)

- SYSTEM OVERVIEW
- FLIGHT INSTRUMENTS
- EIS
- AUDIO PANEL & CNS
- FLIGHT MANAGEMENT
- HAZARD AVOIDANCE
- AFCS
- ADDITIONAL FEATURES
- APPENDICES
- INDEX

- ① **NAV VOL/ID Knob** – Controls NAV audio volume level. Press to turn the Morse code identifier audio on and off. Volume level is shown in the NAV frequency field as a percentage.
- ② **NAV Frequency Transfer Key** – Transfers the standby and active NAV frequencies.
- ③ **NAV Knob** – Tunes the standby frequencies for the NAV receiver (large knob for MHz; small knob for kHz). Press to move the tuning box (light blue box) and Frequency Transfer Arrow between NAV1 and NAV2.
- ④ **NAV Frequency Box** – Displays NAV standby and active frequency fields, volume, and station ID. The frequency of the NAV radio selected for navigation is displayed in green.
- ⑤ **COM Frequency Box** – Displays COM standby and active frequency fields and volume. The selected COM transceiver frequency is displayed in green.
- ⑥ **COM Knob** – Tunes the standby frequencies for the COM transceiver (large knob for MHz; small knob for kHz). Press to move the tuning box (light blue box) and Frequency Transfer Arrow between COM1 and COM2.
- ⑦ **COM Frequency Transfer Key** – Transfers the standby and active COM frequencies. Press and hold this key for two seconds to tune the emergency frequency (121.500 MHz) automatically into the active frequency field.
- ⑧ **COM VOL/SQ Knob** – Controls COM audio volume level. Press to turn the COM automatic squelch on and off. Volume level is shown in the COM frequency field as a percentage.
- ⑨ **ADF/DME Tuning Window** – Displays ADF frequencies, volume setting, and modes, and DME tuning selection. Display by pressing the **ADF/DME** Softkey.
- ⑩ **ENT Key** – Validates or confirms an ADF frequency or ADF/DME mode and Auto-tune selection.
- ⑪ **FMS Knob** – Flight Management System Knob, used to enter transponder codes, enter ADF frequencies, select ADF/DME modes, and Auto-tune entries when ADF/DME Tuning Window or NRST Window is present. Press the **FMS** Knob to turn the selection cursor on and off. The large knob moves the cursor in the window. The small knob selects individual characters for the highlighted cursor location.
- ⑫ **Transponder Data Box** – Indicates the selected transponder code, operating mode, reply, and ident status for the transponder.

## AUDIO PANEL CONTROLS

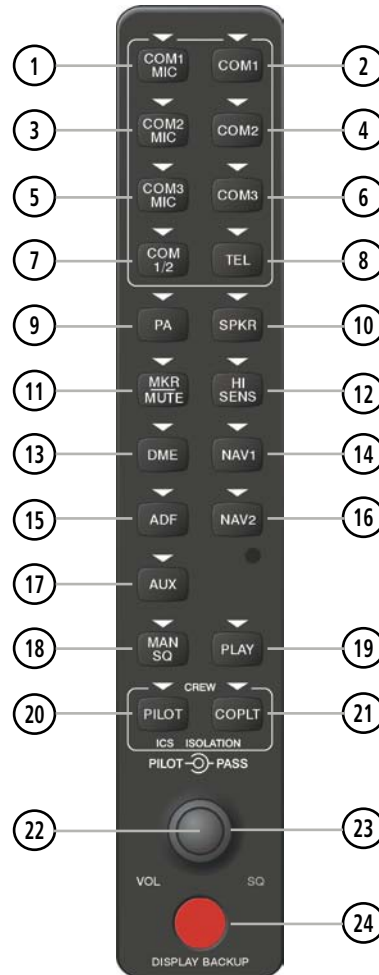

Figure 4-2 Audio Panel Controls



**NOTE:** When a key is selected, a triangular annunciator above the key is illuminated.

- ① **COM1 MIC** – Selects the #1 transmitter for transmitting. COM1 receive is simultaneously selected when this key is pressed allowing received audio from the #1 COM receiver to be heard. COM2 receive can be added by pressing the **COM2** Key.
- ② **COM1** – When selected, audio from the #1 COM receiver can be heard.
- ③ **COM2 MIC** – Selects the #2 transmitter for transmitting. COM2 receive is simultaneously selected when this key is pressed allowing received audio from the #2 COM receiver to be heard. COM1 receive can be added by pressing the **COM1** Key.
- ④ **COM2** – When selected, audio from the #2 COM receiver can be heard.
- ⑤ **COM3 MIC** – Not used in DA40NG aircraft.

- ⑥ **COM3** – Not used in DA40NG aircraft.
- ⑦ **COM 1/2** – Split COM Key. Allows simultaneous transmission on COM1 and COM2 by the pilot and copilot.
- ⑧ **TEL** – Not used in DA40NG aircraft.
- ⑨ **PA** – Not used in DA40NG aircraft.
- ⑩ **SPKR** – Selects and deselects the cabin speaker. COM and NAV receiver audio can be heard on the speaker.
- ⑪ **MKR/MUTE** – Selects marker beacon receiver audio. Mutes the currently received marker beacon receiver audio. Unmutes automatically when new marker beacon audio is received. Also, stops play of recorded COM audio.
- ⑫ **HI SENS** – Press to increase marker beacon receiver sensitivity. Press again to return to low sensitivity.
- ⑬ **DME** – Turns optional DME audio on or off.
- ⑭ **NAV1** – When selected, audio from the #1 NAV receiver can be heard.
- ⑮ **ADF** – Turns optional ADF receiver audio on or off.
- ⑯ **NAV2** – When selected, audio from the #2 NAV receiver can be heard.
- ⑰ **AUX** – Not used in DA40NG aircraft.
- ⑱ **MAN SQ** – Enables manual squelch for the intercom. When the intercom is active, press the **PILOT** Knob to illuminate SQ. Turn the **PILOT/PASS** Knobs to adjust squelch.
- ⑲ **PLAY** – Press once to play the last recorded COM audio. Press again while audio is playing and the previous block of recorded audio is played. Each subsequent press plays each previously recorded block. Pressing the **MKR/MUTE** Key during play of a memory block stops play.
- ⑳ **PILOT** – Selects and deselects the pilot intercom isolation.
- ㉑ **COPLT** – Selects and deselects the copilot intercom isolation.
- ㉒ **PILOT Knob** – Press to switch between volume and squelch control as indicated by illumination of VOL or SQ. Turn to adjust intercom volume or squelch. The **MAN SQ** Key must be selected to allow squelch adjustment.
- ㉓ **PASS Knob** – Turn to adjust Copilot/Passenger intercom volume or squelch. The **MAN SQ** Key must be selected to allow squelch adjustment.
- ㉔ **DISPLAY BACKUP Button** – Manually selects Reversionary Mode.

## 4.2 COM OPERATION

### COM TRANSCIVER SELECTION AND ACTIVATION



**NOTE:** When turning on the G1000 for use, the system remembers the last frequencies used and the active COM transceiver state prior to shutdown.

The COM Frequency Box is composed of four fields; the two active frequencies are on the left side and the two standby frequencies are on the right. The COM transceiver is selected for transmitting by pressing the **COM MIC** Keys on the Audio Panel. During reception of audio from the COM radio selected for transmission, audio from the other COM radio is muted.

An active COM frequency displayed in green indicates that the COM transceiver is selected on the Audio Panel (**COM1 MIC** or **COM2 MIC** Key).

Frequencies in the standby field are displayed in either white or gray. The standby frequency in the tuning box is white. The other standby frequency is gray.

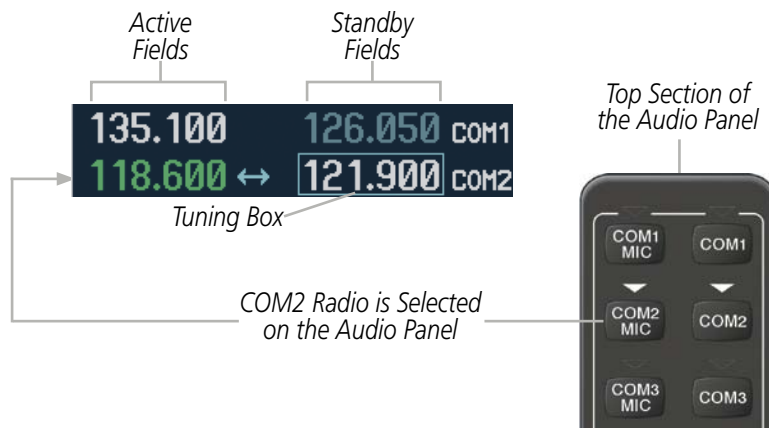

Figure 4-3 Selecting a COM Radio for Transmit

- SYSTEM OVERVIEW
- FLIGHT INSTRUMENTS
- EIS
- AUDIO PANEL & CNS
- FLIGHT MANAGEMENT
- HAZARD AVOIDANCE
- AFCS
- ADDITIONAL FEATURES
- APPENDICES
- INDEX

## TRANSMIT/RECEIVE INDICATIONS

During COM transmission, a white TX appears by the active COM frequency replacing the Frequency Transfer Arrow. On the Audio Panel, when the active COM is transmitting, the active transceiver **COM MIC** Key Annunciator flashes approximately once per second.

During COM signal reception, a white RX appears by the active COM frequency replacing the Frequency Transfer Arrow. Entertainment audio, if selected, is muted during active COM radio reception. Refer to Additional Audio Panel Functions later in this section, and details on the Data Link Receiver in the Additional Features Section.



Figure 4-4 COM Radio Transmit and Receive Indications

## COM TRANSCEIVER MANUAL TUNING

The COM frequency controls and frequency boxes are on the right side of the MFD and PFD.

### Manually tuning a COM frequency:

- 1) Turn the **COM** Knob to tune the desired frequency in the COM Tuning Box (large knob for MHz; small knob for kHz).
- 2) Press the **Frequency Transfer** Key to transfer the frequency to the active field.
- 3) Adjust the volume level with the COM **VOL/SQ** Knob.
- 4) Press the COM **VOL/SQ** Knob to turn automatic squelch on and off.



Figure 4-5 COM Frequency Tuning

## SELECTING THE RADIO TO BE TUNED

Press the small **COM** Knob to transfer the frequency tuning box and Frequency Transfer Arrow between the upper and lower radio frequency fields.

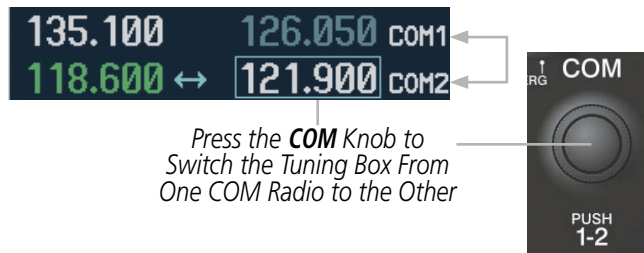

Figure 4-6 Switching COM Tuning Boxes

## QUICK-TUNING AND ACTIVATING 121.500 MHZ

Pressing and holding the **COM Frequency Transfer** Key for two seconds automatically loads the emergency COM frequency (121.500 MHz) in the active field of the COM radio selected for tuning (the one with the transfer arrow). In the example shown, pressing the Audio Panel **COM2 MIC** Key activates the transceiver.

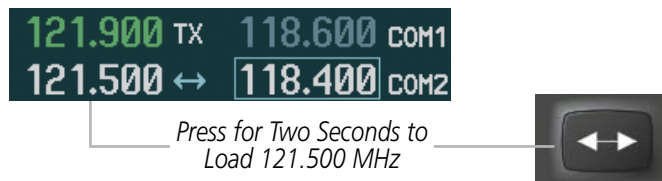

Figure 4-7 Quickly Tuning 121.500 MHz

- SYSTEM OVERVIEW
- FLIGHT INSTRUMENTS
- EIS
- AUDIO PANEL & CNS
- FLIGHT MANAGEMENT
- HAZARD AVOIDANCE
- AFCS
- ADDITIONAL FEATURES
- APPENDICES
- INDEX



## AUTO-TUNING THE COM FREQUENCY

COM frequencies can be automatically tuned from the following:

- Nearest Airports Window (PFD)
- WPT – Airport Information Page
- NRST – Nearest Airports Page
- NRST – Nearest Frequencies Page (ARTCC, FSS, WX)
- NRST – Nearest Airspaces Page

### AUTO-TUNING FROM THE PFD

COM frequencies for the nearest airports can be automatically tuned from the Nearest Airports Window on the PFD. When the desired frequency is entered, it becomes a standby frequency. Pressing the **Frequency Transfer** Key places this frequency into the COM Active Frequency Field.

#### Auto-tuning a COM frequency for a nearby airport from the PFD:

- 1) Press the **NRST** Softkey on the PFD to open the Nearest Airports Window. A list of 25 nearest airport identifiers and COM frequencies is displayed.
- 2) Turn the **FMS** Knob to scroll through the list and highlight the desired COM frequency.
- 3) Press the **ENT** Key to load the COM frequency into the COM Standby Tuning Box.
- 4) Press the **Frequency Transfer** Key to transfer the frequency to the COM Active Frequency Field.



Press the **NRST** Softkey to Open the Nearest Airports Window

Figure 4-8 Nearest Airports Window (PFD)

## AUTO-TUNING FROM THE MFD

Frequencies can be automatically loaded into the COM Frequency Box from pages in the NRST or WPT page group by highlighting the frequency and pressing the **ENT** Key (Figures 4-9, 4-10, and 4-11).

### Auto-tuning a COM frequency from the WPT and NRST Pages:

- 1) From any page that the COM frequency can be auto-tuned, activate the cursor by pressing the **FMS** Knob or the appropriate softkey.
- 2) Turn the **FMS** Knob to place the cursor on the desired COM frequency (Figure 4-11).
- 3) Press the **ENT** Key to load the COM frequency into the standby field of the selected COM radio.
- 4) Press the **Frequency Transfer** Key to transfer the frequency to the COM Active Frequency Field.

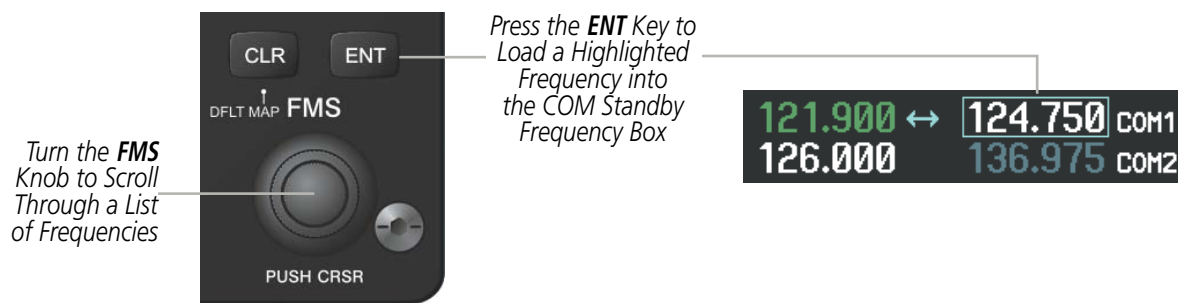

Figure 4-9 Frequency Auto-Tuning from the MFD

Or:

- 1) On the Nearest Airports, Frequencies, or Airspaces page, press the **MENU** Key to display the page menu.
- 2) Turn the large **FMS** Knob to scroll through the menu options.
- 3) Press the **ENT** Key to place the cursor on the desired selection.
- 4) Scroll through the frequency selections with the **FMS** Knob.
- 5) Press the **ENT** Key to load the COM frequency into the standby field of the selected COM radio.
- 6) Press the **Frequency Transfer** Key to transfer the frequency to the COM Active Frequency Field.

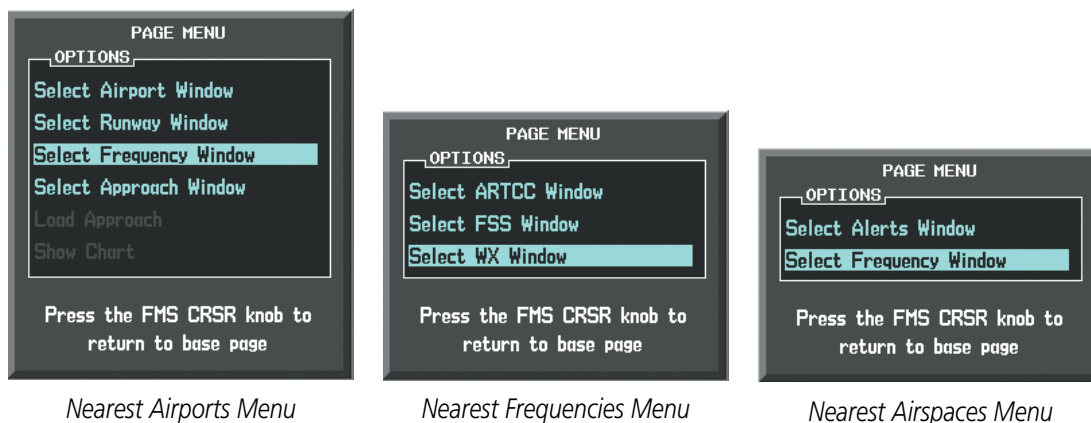
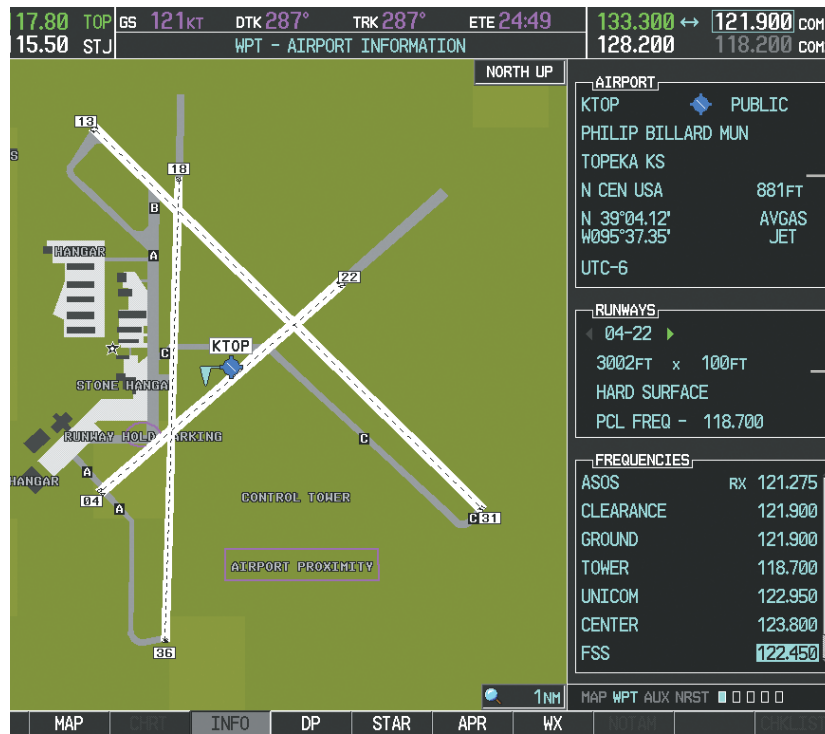

Figure 4-10 Nearest Pages Menus

On the WPT - Airport Information Page, the cursor can be placed on the frequency field by pressing the **FMS** Knob and scrolling through the list. The frequency is transferred to the COM Standby Field with the **ENT** Key.



Press **Frequency Transfer** Key to Load Frequency into COM Active Frequency Field

Selected Airport Identifier and Information

Runway Information

Press **ENT** Key to Load Frequency into COM Standby Field. Cursor then Advances to Next Frequency.

Press **INFO** Softkey for AIRPORT, RUNWAYS, and FREQUENCIES Windows

Figure 4-11 WPT – Airport Information Page

COM frequencies can also be auto-tuned from the NRST – Nearest Airspaces, NRST – Nearest Frequencies, and NRST – Nearest Airports Pages on the MFD in a similar manner using the appropriate softkeys or **MENU** Key, the **FMS** Knob, and the **ENT** Key.



Figure 4-12 NRST – Nearest Airspaces, NRST – Nearest Airports, and NRST – Nearest Frequencies Pages

**FREQUENCY SPACING**

The G1000 COM radios can tune either 25-kHz spacing (118.000 to 136.975 MHz) or 8.33-kHz spacing (118.000 to 136.990 MHz) for 760-channel or 3040-channel configuration. When 8.33-kHz channel spacing is selected, all of the 25-kHz channel spacing frequencies are also available in the complete 3040-channel list.

COM channel spacing is set on the System Setup Page of the AUX Page Group.



Figure 4-13 COM Channel Spacing

**Changing COM frequency channel spacing:**

- 1) Select the AUX – System Setup Page.
- 2) Press the **FMS** Knob to activate the flashing cursor.
- 3) Turn the large **FMS** Knob to highlight the Channel Spacing Field in the COM Configuration Box.
- 4) Turn the small **FMS** Knob to select the desired channel spacing.
- 5) Press the **ENT** Key to complete the channel spacing selection.

While the COM CONFIG Window is selected, the G1000 softkeys are blank.

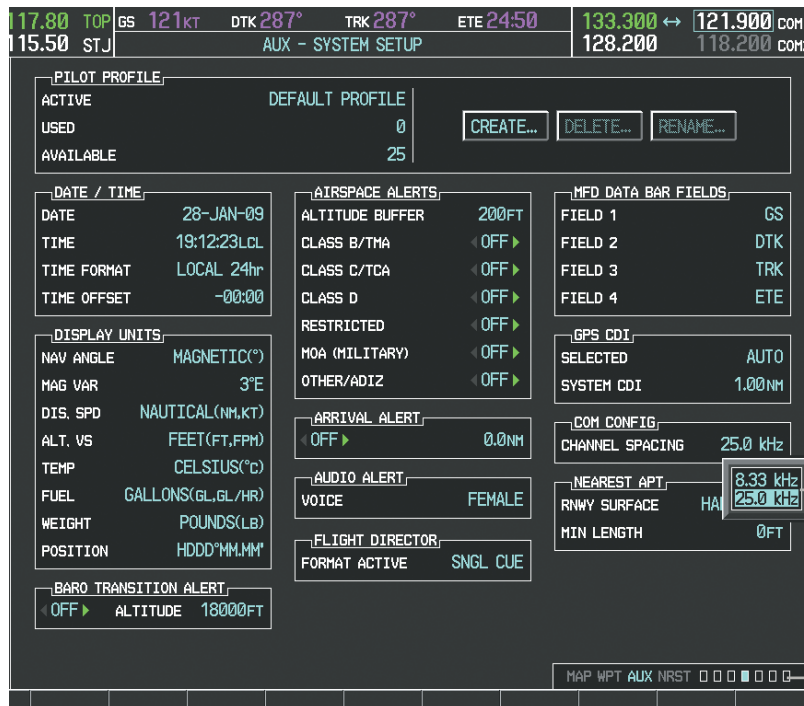

Figure 4-14 AUX – System Setup Page



## AUTOMATIC SQUELCH

Automatic Squelch quiets unwanted static noise when no audio signal is received, while still providing good sensitivity to weak COM signals. To disable Automatic Squelch, press the **VOL/SQ** Knob. When Automatic Squelch is disabled, COM audio reception is always on. Continuous static noise is heard over the headsets and speaker, if selected. Pressing the **VOL/SQ** Knob again enables Automatic Squelch.

When Automatic Squelch is disabled, a white SQ appears next to the COM frequency.



Figure 4-15 Overriding Automatic Squelch

## VOLUME

COM radio volume level can be adjusted from 0 to 100% using the **VOL/SQ** Knob. Turning the knob clockwise increases volume, turning the knob counterclockwise decreases volume. When adjusting volume, the level is displayed in place of the standby frequencies. Volume level indication remains for two seconds after the change.



Figure 4-16 COM Volume Level

### 4.3 NAV OPERATION

#### NAV RADIO SELECTION AND ACTIVATION

The NAV Frequency Box is composed of four fields; two standby fields and two active fields. The active frequencies are on the right side and the standby frequencies are on the left.

A NAV radio is selected for navigation by pressing the **CDI** Softkey located on the PFD. The active NAV frequency selected for navigation is displayed in green. Pressing the **CDI** Softkey once selects NAV1 as the navigation radio. Pressing the **CDI** Softkey a second time selects NAV2 as the navigation radio. Pressing the **CDI** Softkey a third time activates GPS mode. Pressing the **CDI** Softkey again cycles back to NAV1.

While cycling through the **CDI** Softkey selections, the NAV Tuning Box and the Frequency Transfer Arrow are placed in the active NAV Frequency Field and the active NAV frequency color changes to green.

The three navigation modes that can be cycled through are:

- VOR1 (or LOC1) – If NAV1 is selected, a green single line arrow (not shown) labeled either VOR1 or LOC1 is displayed on the HSI and the active NAV1 frequency is displayed in green.
- VOR2 (or LOC2) – If NAV2 is selected, a green double line arrow (shown) labeled either VOR2 or LOC2 is displayed on the HSI and the active NAV2 frequency is displayed in green.
- GPS – If GPS Mode is selected, a magenta single line arrow (not shown) appears on the HSI and neither NAV radio is selected. Both active NAV frequencies are then displayed in white.

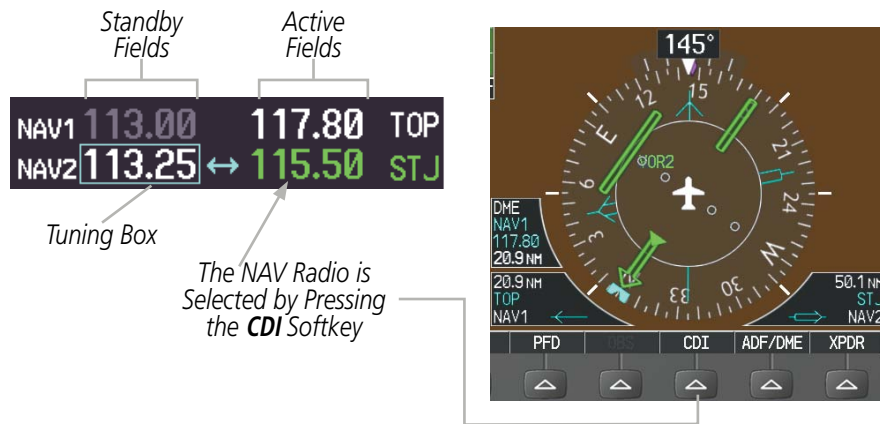

Figure 4-17 Selecting a NAV Radio for Navigation

See the Flight Instruments Section for selecting the DME and Bearing Information windows and using VOR or ADF as the source for the bearing pointer.



NAV radios are selected for listening by pressing the corresponding keys on the Audio Panel. Pressing the **NAV1**, **NAV2**, **ADF**, or **DME** Key selects and deselects the navigation radio source. Selected audio can be heard over the headset and the speaker (if selected). All radios can be selected individually or simultaneously.



Figure 4-18 Selecting a NAV Radio Receiver

### NAV RECEIVER MANUAL TUNING

The NAV frequency controls and frequency boxes are on the left side of the MFD and PFD.

#### Manually tuning a NAV frequency:

- 1) Turn the **NAV** Knob to tune the desired frequency in the NAV Tuning Box.
- 2) Press the **Frequency Transfer** Key to transfer the frequency to the NAV Active Frequency Field.
- 3) Adjust the volume level with the NAV **VOL/ID** Knob.
- 4) Press the NAV **VOL/ID** Knob to turn the Morse code identifier audio on and off.

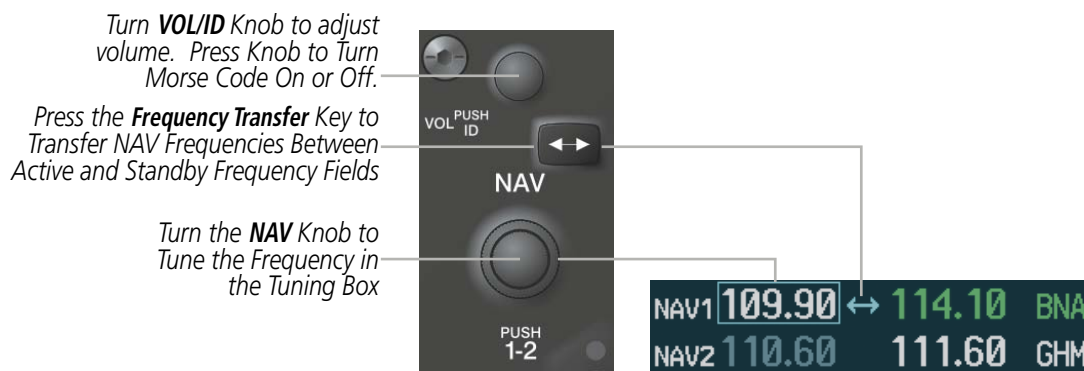

Figure 4-19 NAV Frequency Tuning

## SELECTING THE RADIO TO BE TUNED

Press the small **NAV** Knob to transfer the frequency tuning box and Frequency Transfer Arrow between the upper and lower radio frequency fields.

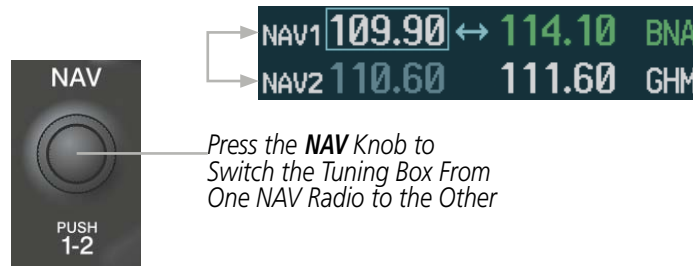

Figure 4-20 Switching NAV Tuning Boxes

## VOR/LOC ID

When the Morse code Identifier audio is on for a NAV radio, a white ID appears to the left of the active NAV frequency.

In the example shown, in order to listen to either station identifier, press the **NAV1** or **NAV2** Key on the Audio Panel. Pressing the **VOL/ID** Knob turns off the Morse code audio only in the radio with the NAV Tuning Box. To turn off both NAV IDs, transfer the NAV Tuning Box between NAV1 and NAV2 by pressing the small **NAV** Knob and pressing the **VOL/ID** Knob again to turn the Morse code off in the other radio.

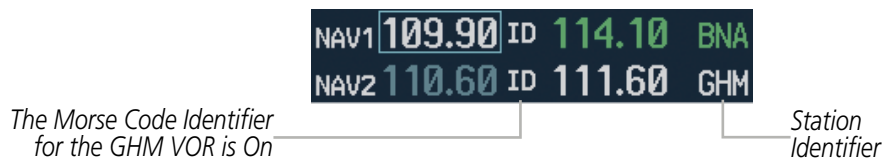

Figure 4-21 NAV Radio ID Indication

## VOLUME

NAV Radio volume level can be adjusted from 0 to 100% using the **VOL/ID** Knob. Turning the knob clockwise increases volume, counterclockwise decreases volume.

When adjusting, the level is displayed in place of the standby frequencies. Volume level indication remains for two seconds after the change.



Figure 4-22 NAV Volume Levels

## AUTO-TUNING A NAV FREQUENCY FROM THE MFD

NAV frequencies can be selected and loaded from the following MFD pages:

- WPT – Airport Information
- WPT – VOR Information
- NRST – Nearest Airports
- NRST – Nearest VOR
- NRST – Nearest Frequencies (FSS, WX)
- NRST – Nearest Airspaces

The MFD provides auto-tuning of NAV frequencies from waypoint and nearest pages. During enroute navigation, the NAV frequency is entered automatically into the NAV standby frequency field. During approach activation the NAV frequency is entered automatically into the NAV active frequency field.

Frequencies can be automatically loaded into the NAV Frequency Box from pages in the NRST or WPT page group by highlighting the frequency and pressing the **ENT** Key (Figures 4-23, 4-24, and 4-25).

### Auto-tuning a NAV frequency from the WPT and NRST Pages:

- 1) From any page that the NAV frequency can be auto-tuned, activate the cursor by pressing the **FMS** Knob or the appropriate softkey.
- 2) Turn the **FMS** Knob to place the cursor on the desired NAV identifier or NAV frequency.
- 3) On the Nearest VOR, Nearest Airspaces, and Nearest Airports pages, press the **FREQ** Softkey to place the cursor on the NAV frequency (Figure 4-25).
- 4) Press the **ENT** Key to load the NAV frequency into the standby field of the selected NAV radio.
- 5) Press the **Frequency Transfer** Key to transfer the frequency to the NAV Active Frequency Field.

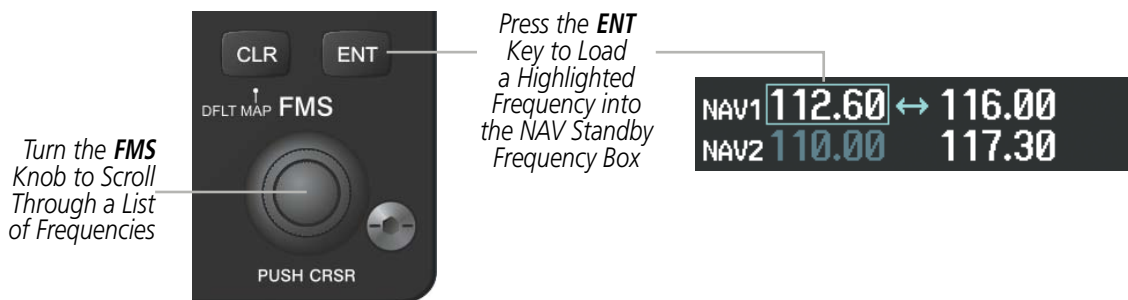

Figure 4-23 NAV Frequency Auto-Tuning from the MFD

Or:

- 1) When on the NRST pages, press the **MENU** Key to display the page menu.
- 2) Turn the large **FMS** Knob to scroll through the menu options.
- 3) Press the **ENT** Key to place the cursor in the desired window.
- 4) Scroll through the frequency selections with the **FMS** Knob.
- 5) Press the **ENT** Key to load the NAV frequency into the standby field of the selected NAV radio.
- 6) Press the **Frequency Transfer** Key to transfer the frequency to the NAV Active Frequency Field.

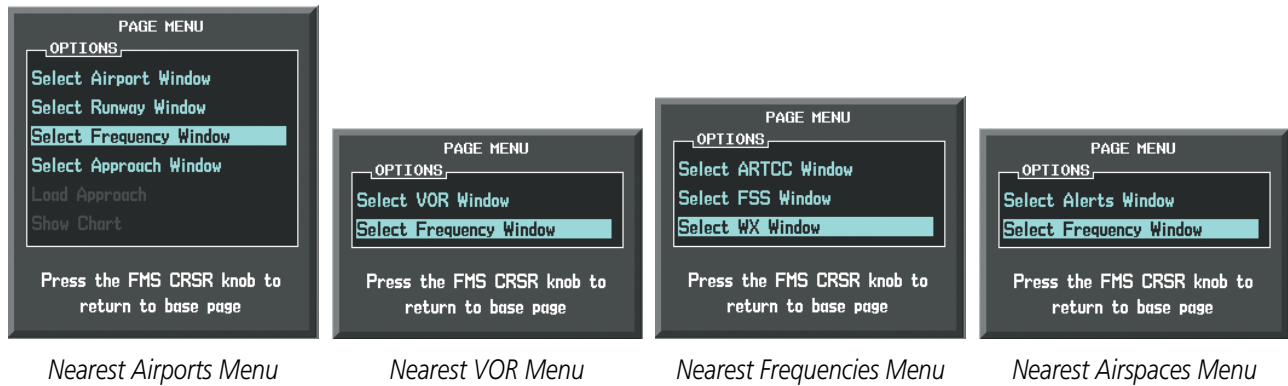

Figure 4-24 Nearest Pages Menus

SYSTEM OVERVIEW

FLIGHT INSTRUMENTS

EIS

AUDIO PANEL & CNS

FLIGHT MANAGEMENT

HAZARD AVOIDANCE

AFCS

ADDITIONAL FEATURES

APPENDICES

INDEX

In the example shown, the VOR list is selected with the **VOR** Softkey or from the page menu. The **FMS** Knob or **ENT** Key is used to scroll through the list. The cursor is placed on the frequency with the **FREQ** Softkey and loaded into the NAV Tuning Box with the **ENT** Key.



Press the **ENT** Key to Load the Frequency into the NAV Standby Field.

Press the **VOR** Softkey to place the cursor on the VOR Identifier

Press the **FREQ** Softkey to place the cursor on the VOR Frequency

Figure 4-25 Loading the NAV Frequency from the NRST – Nearest VOR Page

While enroute, NAV frequencies can also be auto-tuned from the NRST – Nearest Airports, WPT – Airport Information, WPT – VOR Information, and NRST – Nearest Frequencies Pages on the MFD in a similar manner using the appropriate softkeys or **MENU** Key, the **FMS** Knob, and the **ENT** Key.



Figure 4-26 NRST – Nearest Frequencies, WPT – VOR Information, WPT – Airport Information, and NRST – Nearest Airports Pages

## AUTO-TUNING NAV FREQUENCIES ON APPROACH ACTIVATION



**NOTE:** The primary NAV frequency is auto-tuned upon loading a VOR or ILS/Localizer approach.



**NOTE:** When an ILS/LOC approach has been activated while navigating by GPS, the system automatically switches to LOC as the final approach course is intercepted (within 15 nm of the FAF). See the Flight Management Section for details.

NAV frequencies are automatically loaded into the NAV Frequency Box on approach activation.

When loading or activating a VOR or ILS/LOC approach, the approach frequency is automatically transferred to a NAV frequency field as follows:

- If the current CDI navigation source is GPS, the approach frequency is transferred to the NAV1 active frequency field. The frequency that was previously in the NAV1 active frequency field is transferred to standby.
- If the current CDI navigation source is GPS, and if the approach frequency is already loaded into the NAV1 standby frequency field, the standby frequency is transferred to active.
- If the current CDI navigation source is NAV1 or NAV2, the approach frequency is transferred to the standby frequency fields of the selected CDI NAV radio.



## MARKER BEACON RECEIVER

**NOTE:** The marker beacon indicators operate independently of marker beacon audio and cannot be turned off.

The marker beacon receiver is used as part of the ILS. The marker beacon receiver is always on and detects any marker beacon signals within the reception range of the aircraft.

The receiver detects the three marker tones – outer, middle, and inner – and provides the marker beacon annunciations located to the left of the Altimeter on the PFD.

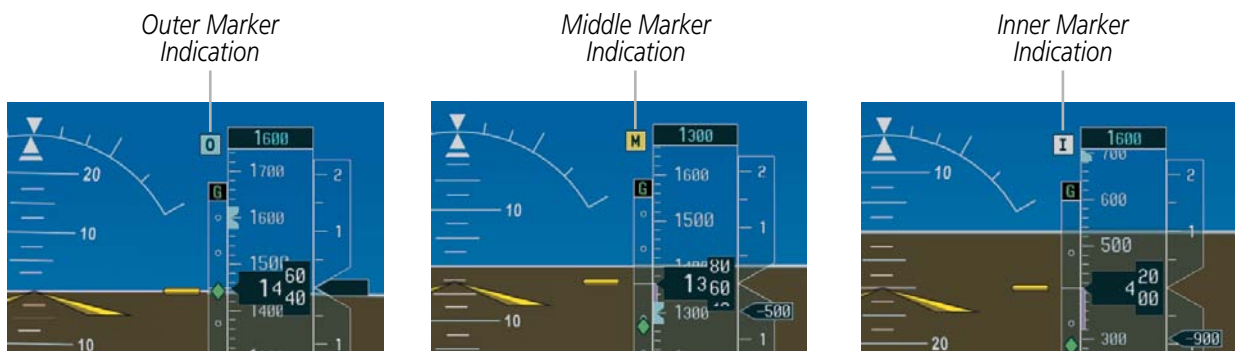

Figure 4-27 Marker Beacon Annunciations on the PFD



Figure 4-28 Marker Beacon Keys

The Audio Panel provides three different states of marker beacon operation; On, Muted, and Deselected. Pressing the **MKR/MUTE** Key selects and deselects marker beacon audio. The key annunciator indicates when marker beacon audio is selected.

During marker beacon audio reception, pressing the **MKR/MUTE** Key mutes the audio but does not affect the marker annunciations (Figure 4-27). The marker tone is silenced, then waits for the next marker tone. The **MKR/MUTE** Key Annunciator is illuminated, indicating audio muting. The audio returns when the next marker beacon signal is received. If the **MKR/MUTE** Key is pressed during signal reception (O, M, I indication) while marker beacon audio is muted, the audio is deselected and the **MKR/MUTE** Key Annunciator is extinguished.

Pressing the **HI SENS** Key switches between high and low marker beacon receiver sensitivity. The HI SENS function (annunciator illuminated) is used to provide an earlier indication when nearing a marker during an approach. The LO SENS function (annunciator extinguished) results in a narrower marker dwell while over a station.

## ADF/DME TUNING

**NOTE:** When another auxiliary window is turned on, the ADF/DME Tuning Window is replaced on the PFD.

See the Flight Instruments Section for displaying the DME and bearing information windows (ADF) and using the ADF as the source for the bearing pointer.

The G1000 system tunes the ADF receiver (optional) and DME transceiver (optional). The ADF is tuned by entering the frequency in the ADF standby frequency field of the ADF/DME Tuning Window. (The softkey may be labeled **ADF/DME**, **ADF**, or **DME**, depending on installed equipment.)

The UHF DME frequency is tuned by pairing with a VHF NAV frequency. DME frequency pairing is automatic and only the VHF NAV frequency is shown.

The following ADF/DME information is displayed in the ADF/DME Tuning Window:

- Active and standby ADF frequencies
- ADF receiver mode
- ADF receiver volume
- DME tuning mode (DME transceiver pairing)

When the ADF/DME Tuning Window is displayed, the selection cursor is placed over the standby ADF frequency field.

Turning the large **FMS** Knob moves the selection cursor through the various fields (standby ADF frequency, ADF receiver mode, ADF radio volume, and DME tuning mode). Pressing the **FMS** Knob activates/deactivates the selection cursor in the ADF/DME Tuning Window. The ADF frequency is entered using the **FMS** Knob and the **ENT** Key.

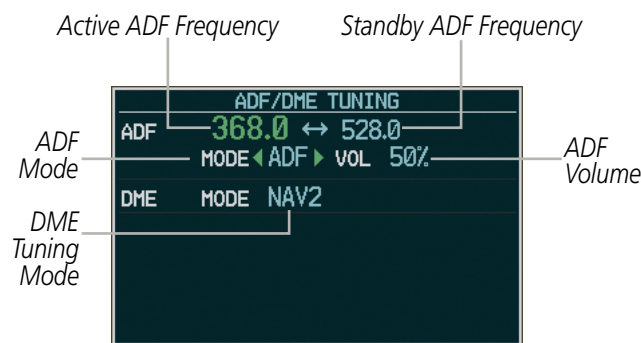

Figure 4-29 ADF/DME Tuning Window

## ADF TUNING

ADF frequencies in the 190.0-kHz to 1799.5-kHz range are entered in the standby ADF frequency field of the ADF/DME Tuning Window. The G1000 System does not tune the ADF emergency frequency, 2182.0-kHz.

### Tuning an ADF frequency:

- 1) Press the **ADF/DME** Softkey to display the ADF/DME Tuning Window.
- 2) Turn the large **FMS** Knob to place the selection cursor over the standby ADF frequency field.
- 3) Turn the small **FMS** Knob to begin data entry and change each digit.
- 4) Turn the large **FMS** Knob to move the cursor to the next digit position.
- 5) Press the **ENT** Key to complete data entry for the standby frequency.

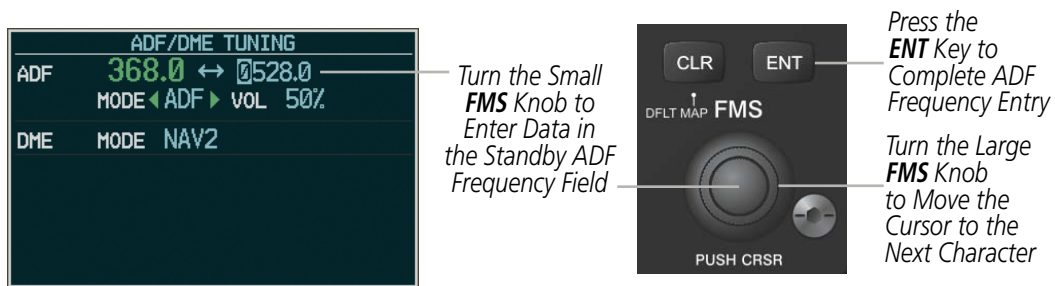

Figure 4-30 Entering ADF Standby Frequencies

Pressing the **CLR** Key before completing frequency entry cancels the frequency change and reverts back to the previously entered frequency.

Pressing the **CLR** Key when the cursor is flashing, clears the frequency and replaces the standby field with 0000.0.

### Transferring the active and standby ADF frequencies:

- 1) Turn the large **FMS** Knob to place the selection cursor over the standby ADF frequency field.
- 2) Press the **ENT** Key to complete the frequency transfer.

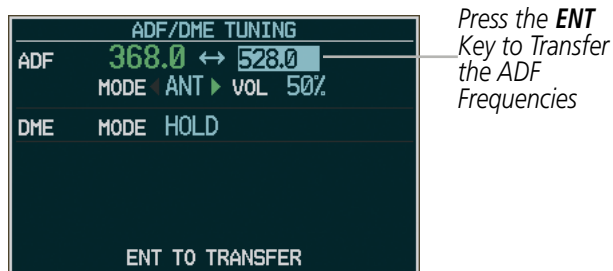

Figure 4-31 Transferring ADF Frequencies

## SELECTING ADF RECEIVER MODE

The following modes can be selected: (In all modes NDB audio can be heard by selecting the **ADF** Key on the Audio Panel.)

- ANT (Antenna) – The ADF bearing pointer parks on the HSI at 90 degrees. Best mode for listening to NDB audio.
- ADF (Automatic Direction Finder) – The ADF pointer points to the relative bearing of the NDB station.
- ADF/BFO (ADF/Beat Frequency Oscillator) – The ADF pointer points to the relative bearing of the NDB station and an audible tone confirms signal reception. This mode allows identification of the interrupted carrier beacon stations used in various parts of the world.
- ANT/BFO (Antenna/Beat Frequency Oscillator) – The ADF bearing pointer parks on the HSI at 90 degrees while an audible tone is provided when a signal is received. This mode also allows identification of the interrupted carrier beacon stations and confirms signal reception.

### Selecting an ADF receiver mode:

- 1) Turn the large **FMS** Knob to place the selection cursor over the ADF mode field.
- 2) Turn the small **FMS** Knob to select the desired ADF receiver mode.

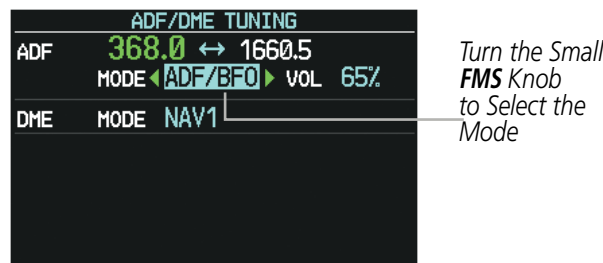

Figure 4-32 Selecting ADF Receiver Mode

ADF receiver volume level can be adjusted in the tuning window from 0 to 100%. The default volume level is set to 50%. The ADF volume level is the same for both Audio Panels.

### Adjusting ADF receiver volume:

- 1) Turn the large **FMS** Knob to place the selection cursor over the ADF volume field.
- 2) Turn the small **FMS** Knob to adjust volume as desired.

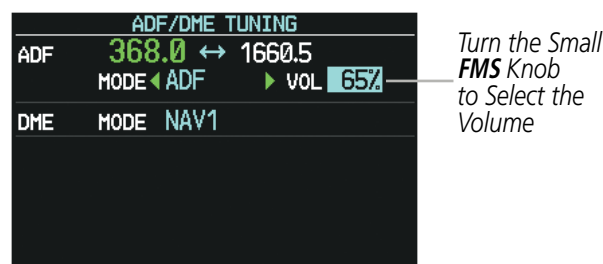

Figure 4-33 Adjusting ADF Receiver Volume

## DME TUNING

**NOTE:** When turning on the G1000 for use, the system remembers the last frequency used for DME tuning and the NAV1, NAV2, or HOLD state prior to shutdown.

The DME transceiver is tuned by selecting NAV1, NAV2, or HOLD in the ADF/DME Tuning Window.

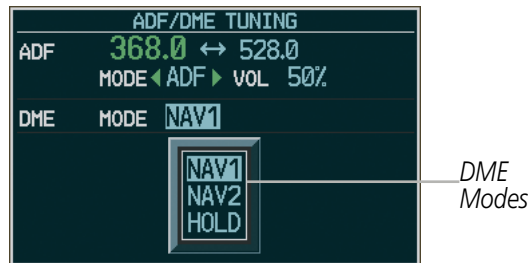

Figure 4-34 ADF/DME Tuning Window, DME Modes

The following DME transceiver pairings can be selected:

- NAV1 – Pairs the DME frequency from the selected NAV1 frequency.
- NAV2 – Pairs the DME frequency from the selected NAV2 frequency.
- HOLD – When in the HOLD position, the DME frequency remains paired with the last selected NAV frequency.

#### Selecting DME transceiver pairing:

- 1) Press the **ADF/DME** Softkey to display the ADF/DME Tuning Window.
- 2) Turn the small **FMS** Knob to select the DME tuning mode.
- 3) Press the **ENT** Key to complete the selection.

Pressing the **CLR** Key or **FMS** Knob while in the process of DME pairing cancels the data entry and reverts back to the previously selected DME tuning state. Pressing the **FMS** Knob activates/deactivates the cursor in the ADF/DME Tuning Window.

## 4.4 GTX 33 MODE S TRANSPONDER

The GTX 33 Mode S Transponder provides Mode A, Mode C, and Mode S interrogation and reply capabilities. Selective addressing or Mode Select (Mode S) capability includes the following features:

- Level-2 reply data link capability (used to exchange information between aircraft and ATC facilities)
- Surveillance identifier capability
- Altitude reporting
- Airborne status determination
- Transponder capability reporting
- Mode S Enhanced Surveillance (EHS) requirements
- Acquisition squitter – Acquisition squitter, or short squitter, is the transponder 24-bit identification address. The transmission is sent periodically, regardless of the presence of interrogations. The purpose of acquisition squitter is to enable Mode S ground stations and aircraft equipped with a Traffic Avoidance System (TAS) to recognize the presence of Mode S-equipped aircraft for selective interrogation.

The Hazard Avoidance Section provides more details on traffic avoidance systems.

### TRANSPONDER CONTROLS

Transponder function is displayed on three levels of softkeys on the PFD: Top-level, Mode Selection, and Code Selection. When the top-level **XPDR** Softkey is pressed, the Mode Selection softkeys appear: **STBY, ON, ALT, VFR, CODE, IDENT, BACK**.

When the **CODE** Softkey is pressed, the number softkeys appear: **0, 1, 2, 3, 4, 5, 6, 7, IDENT, BKSP, BACK**. The digits 8 and 9 are not used for code entry. Pressing the numbered softkeys in sequence enters the transponder code. If an error is made, the code selection cursor can be moved back to the left one digit with each press of the **BKSP** Softkey.

Pressing the **BACK** Softkey during code selection reverts to the Mode Selection Softkeys. Pressing the **BACK** Softkey during mode selection reverts to the top-level softkeys.

The code can also be entered with the **FMS** Knob on the PFD. Code entry must be completed with either the softkeys or the **FMS** Knob, but not a combination of both.

Pressing the **IDENT** Softkey while in Mode or Code Selection initiates the ident function and reverts to the top-level softkeys.

After 45 seconds of transponder softkey inactivity, the system reverts back to the top-level softkeys.

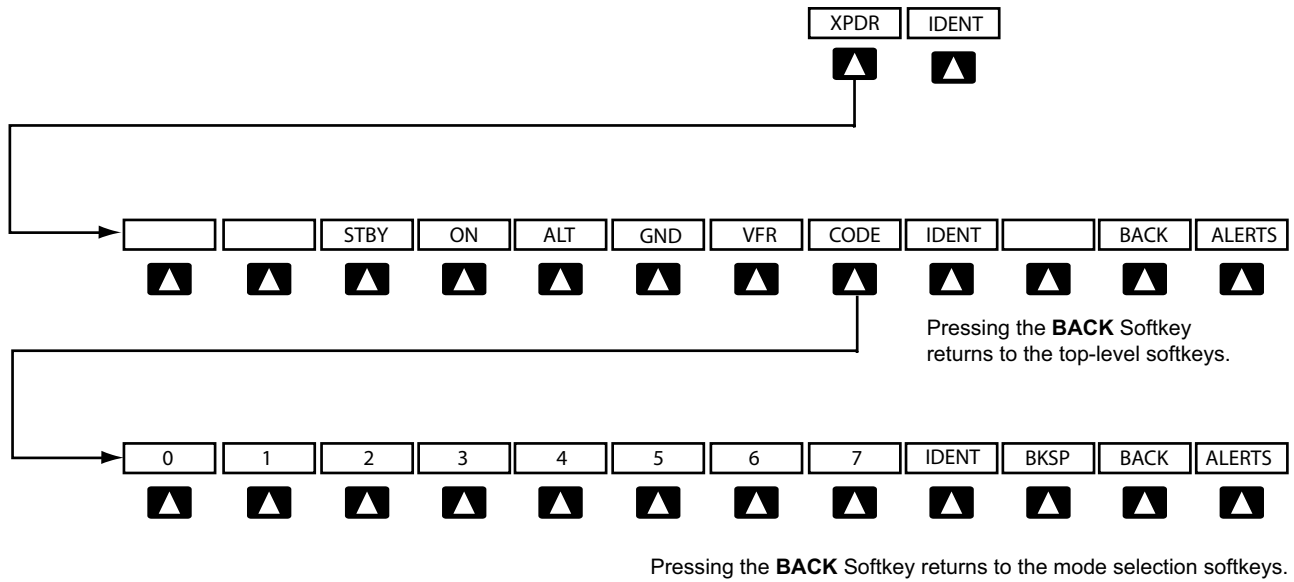

Figure 4-35 Transponder Softkeys (PFD)

## TRANSPONDER MODE SELECTION

Mode selection can be automatic (Ground and Altitude Modes) or manual (Standby, ON, and Altitude Modes). The **STBY**, **ON**, and **ALT** Softkeys can be accessed by pressing the **XPDR** Softkey.

### Selecting a transponder mode:

- 1) Press the **XPDR** Softkey to display the Transponder Mode Selection Softkeys.
- 2) Press the desired softkey to activate the transponder mode.

## GROUND MODE

Ground Mode is normally selected automatically when the aircraft is on the ground. The transponder powers up in the last mode it was in when shut down. Ground Mode can be overridden by pressing any one of the Mode Selection Softkeys. A green **GND** indication and transponder code appear in the mode field of the Transponder Data Box. In Ground Mode, the transponder does not allow Mode A and Mode C replies, but it does permit acquisition squitter and replies to discretely addressed Mode S interrogations.

When Standby Mode has been selected on the ground, the transponder can be returned to Ground Mode by pressing the **GND** Softkey.



Figure 4-36 Ground Mode



## STANDBY MODE (MANUAL)

**NOTE:** In Standby Mode, the IDENT function is inoperative.

Standby Mode can be selected at any time by pressing the **STBY** Softkey. In Standby, the transponder does not reply to interrogations, but new codes can be entered. When Standby is selected, a white STBY indication and transponder code appear in the mode field of the Transponder Data Box. In all other modes, these fields appear in green.

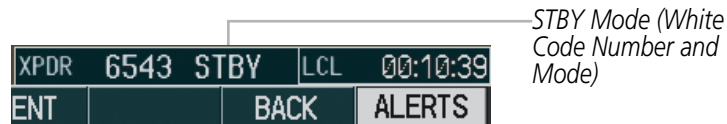

Figure 4-37 Standby Mode

## MANUAL ON MODE

ON Mode can be selected at any time by pressing the **ON** Softkey. ON Mode generates Mode A and Mode S replies, but Mode C altitude reporting is inhibited. In ON Mode, a green ON indication and transponder code appear in the mode field of the Transponder Data Box.

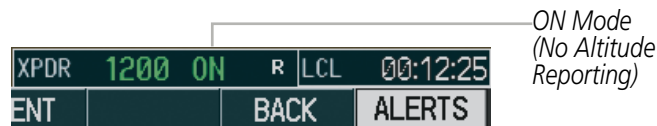

Figure 4-38 ON Mode

## ALTITUDE MODE (AUTOMATIC OR MANUAL)

Altitude Mode is automatically selected when the aircraft becomes airborne. Altitude Mode may also be selected manually by pressing the **ALT** Softkey.

If Altitude Mode is selected, a green ALT indication and transponder code appear in the mode field of the Transponder Data Box, and all transponder replies requesting altitude information are provided with pressure altitude information.

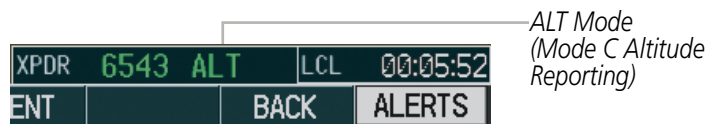

Figure 4-39 Altitude Mode

## REPLY STATUS

When the transponder sends replies to interrogations, a white R indication appears momentarily in the reply status field of the Transponder Data Box.



Figure 4-40 Reply Indication

## ENTERING A TRANSPONDER CODE

### Entering a transponder code with softkeys:

- 1) Press the **XPDR** Softkey to display the Transponder Mode Selection Softkeys.
- 2) Press the **CODE** Softkey to display the Transponder Code Selection Softkeys, for digit entry.
- 3) Press the digit softkeys to enter the code in the code field. When entering the code, the next softkey in sequence must be pressed within 10 seconds, or the entry is cancelled and restored to the previous code. Pressing the **BKSP** Softkey moves the code selection cursor to the previous digit. Five seconds after the fourth digit has been entered, the transponder code becomes active.



Figure 4-41 Entering a Code

### Entering a transponder code with the PFD FMS Knob:

- 1) Press the **XPDR** and the **CODE** Softkeys as in the previous procedure to enable code entry.
- 2) Turn the small **FMS** Knob on the PFD to enter the first two code digits.
- 3) Turn the large **FMS** Knob to move the cursor to the next code field.
- 4) Enter the last two code digits with the small **FMS** Knob.
- 5) Press the **ENT** Key to complete code digit entry.

Pressing the **CLR** Key or small **FMS** Knob before code entry is complete cancels code entry and restores the previous code. Waiting for 10 seconds after code entry is finished activates the code automatically.

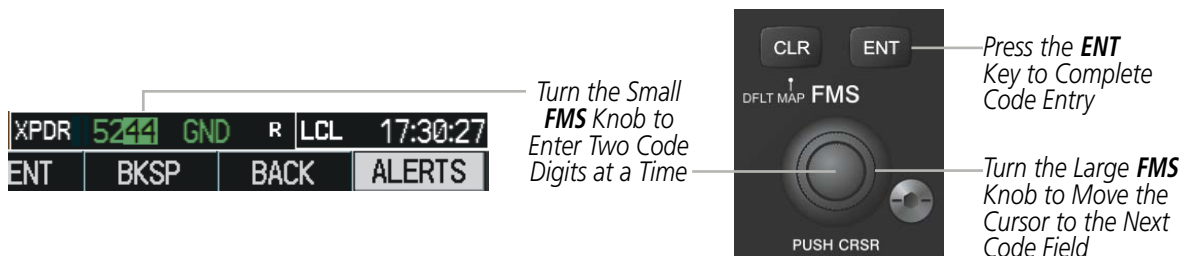

Figure 4-42 Entering a Code with the FMS Knob

## VFR CODE

The VFR code can be entered either manually or by pressing the **XPDR** Softkey, then the **VFR** Softkey. When the **VFR** Softkey is pressed, the pre-programmed VFR code is automatically displayed in the code field of the Transponder Data Box. Pressing the **VFR** Softkey again restores the previous identification code.

The pre-programmed VFR Code is set at the factory to 1200. If a VFR code change is required, contact a Garmin-authorized service center for configuration.

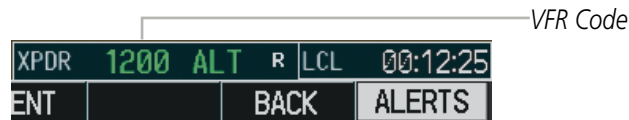

Figure 4-43 VFR Code

## IDENT FUNCTION



**NOTE:** In Standby Mode, the **IDENT** Softkey is inoperative.

Pressing the **IDENT** Softkey sends a distinct identity indication to Air Traffic Control (ATC). The indication distinguishes the identifying transponder from all the others on the air traffic controller's screen. The **IDENT** Softkey appears on all levels of transponder softkeys. When the **IDENT** Softkey is pressed, a green IDNT indication is displayed in the mode field of the Transponder Data Box for a duration of 18 seconds.

After the **IDENT** Softkey is pressed while in Mode or Code Selection, the system reverts to the top-level softkeys.

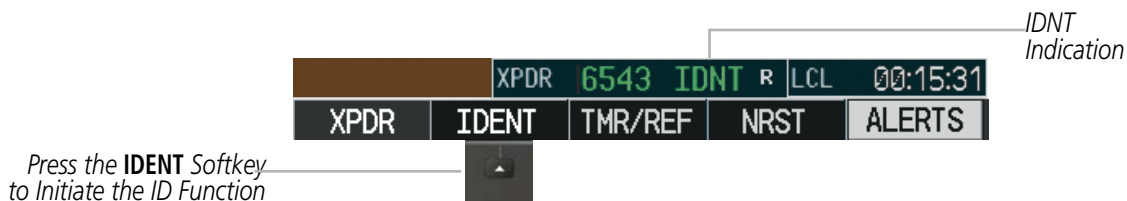

Figure 4-44 IDENT Softkey and Indication

## 4.5 ADDITIONAL AUDIO PANEL FUNCTIONS

### POWER-UP

The Audio Panel performs a self-test during power-up. During the self-test all Audio Panel annunciator lights illuminate for approximately two seconds. Once the self-test is completed, most of the settings are restored to those in use before the unit was last turned off.

### MONO/STEREO HEADSETS

Stereo headsets are recommended for use in this aircraft.

Using a monaural headset in a stereo jack shorts the right headset channel output to ground. While this does not damage the Audio Panel, a person listening on a monaural headset hears only the left channel in both ears. If a monaural headset is used at one of the passenger positions, any other passenger using a stereo headset hears audio in the left ear only.

### SPEAKER

All of the radios can be heard over the cabin speaker. Pressing the **SPKR** Key selects and deselects the cabin speaker. Speaker audio is muted when the PTT is pressed. Certain aural alerts and warnings (autopilot, traffic, altitude) are always heard on the speaker, even when the speaker is not selected.

The speaker volume is adjustable within a nominal range. Contact a Garmin-authorized service center for volume adjustment.



Figure 4-45 Passenger Address and Speaker Keys

## INTERCOM

The Audio Panel includes a four-position intercom system (ICS) and a stereo music input for the pilot, copilot and up to two passengers. The intercom provides Pilot and Copilot isolation from the passengers and aircraft radios.



Figure 4-46 Intercom Controls

PILOT KEY Annunciator	COPLT KEY Annunciator	Pilot Hears	Copilot Hears	Passenger Hears
OFF	OFF	Selected radios, aural alerts, pilot, copilot, passengers, music	Selected radios, aural alerts, pilot, copilot, passengers, music	Selected radios, aural alerts, pilot, copilot, passengers, music
ON	OFF	Selected radios, aural alerts, pilot	Copilot, passengers, music	Copilot, passengers, music
OFF	ON	Selected radios, aural alerts, pilot; passengers, music	Copilot	Selected radios, aural alerts, pilot, passengers, music
ON	ON	Selected radios, aural alerts, pilot, copilot	Selected radios, aural alerts, pilot, copilot	Passengers; music

Table 4-1 ICS Isolation Modes

Pilot isolation is selected when the PILOT Annunciator is illuminated. During Pilot isolation, the pilot can hear the selected radios and aural alerts and warnings. The copilot and passengers can communicate with each other. The copilot is isolated from aural alerts and warnings.

Copilot isolation is selected when the COPLT Annunciator is illuminated. The copilot is isolated from the selected radios, aural alerts and warnings, and everyone else. The pilot and passengers can hear the selected radios and communicate with each other.

When both the PILOT and COPLT Annunciators are illuminated, the pilot and copilot can hear the selected radios and communicate with each other. The passengers are isolated from the pilot and copilot but can communicate with each other.

When both the PILOT and COPLT Annunciators are extinguished, everyone hears the selected radios and is able to communicate with everyone else.

## INTERCOM VOLUME AND SQUELCH

The **PILOT/PASS** Knob controls volume or manual squelch adjustment for the pilot and copilot/passenger. The small knob controls the pilot volume and squelch. The large knob controls the copilot/passenger volume and squelch. The VOL and SQ annunciators at the bottom of the unit indicate which function the knob is controlling. Pressing the **PILOT/PASS** Knob switches between volume and squelch control as indicated by the VOL or SQ annunciation being illuminated.

The **MAN SQ** Key allows either automatic or manual control of the squelch setting.

- When the MAN SQ Annunciator is extinguished (Automatic Squelch is on), the **PILOT/PASS** Knob controls only the volume (pressing the **PILOT/PASS** Knob has no effect on the VOL/SQ selection).
- When the MAN SQ Annunciator is illuminated (Manual Squelch), the **PILOT/PASS** Knob controls either volume or squelch (selected by pressing the **PILOT/PASS** Knob and indicated by the VOL or SQ annunciation).

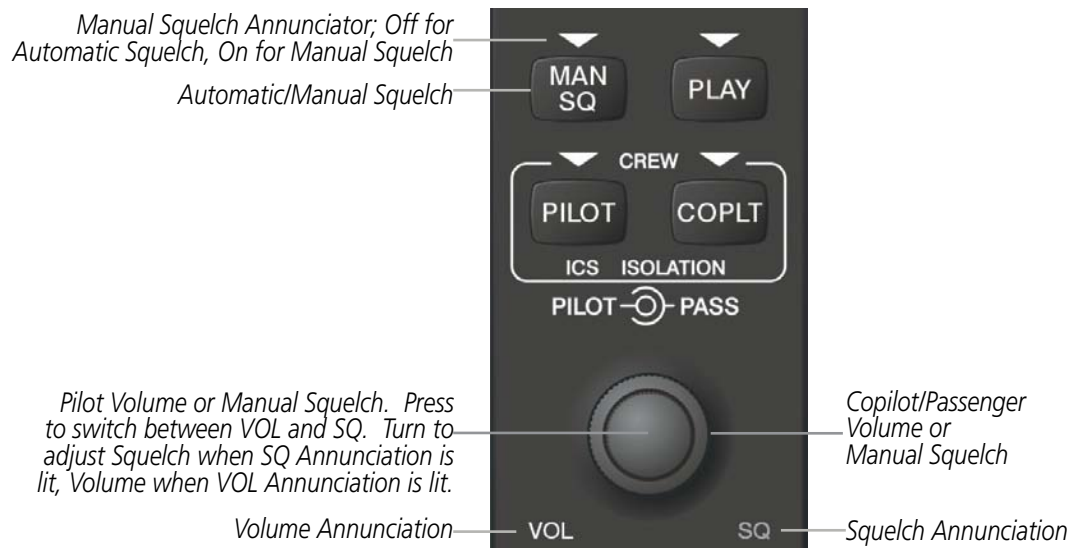

Figure 4-47 Volume/Squelch Control

## CLEARANCE RECORDER AND PLAYER

The Audio Panel contains a digital clearance recorder that continually records up to 2.5 minutes of the selected COM radio signal. Recorded COM audio is stored in separate memory blocks. Once 2.5 minutes of recording time have been reached, the recorder begins recording over the stored memory blocks, starting from the oldest block.

The **PLAY** Key controls the play function. Pressing the **PLAY** Key once plays the latest recorded memory block. The PLAY Annunciator flashes to indicate when play is in progress. The PLAY Annunciator turns off after the present memory block has finished playing.

Pressing the **MKR/MUTE** Key during play of a memory block stops play. If a COM input signal is detected during play of a recorded memory block, play is halted.

Pressing the **PLAY** Key while audio is playing begins playing the previously recorded memory block. Each subsequent press of the **PLAY** Key selects the previously recorded memory block.

Powering off the unit automatically clears all recorded blocks.



Figure 4-48 Marker Mute and Play Keys



**SPLIT COM**

**NOTE:** Split COM performance is affected by the distance between the COM antennas and the separation of the tuned frequencies. If the selected COM1 and COM2 frequencies are too close together, interference may be heard during transmission on the other radio.

During Split COM operation, both the pilot and the copilot can transmit simultaneously over separate radios. The pilot can still monitor NAV1, NAV2, ADF, DME, and MKR Audio as selected, but the copilot is only able to monitor COM2.

Pressing the **COM 1/2** Key selects Split COM operation. The COM 1/2 Annunciator is illuminated indicating Split COM operation. COM1 and COM2 frequencies are displayed in green indicating that both transceivers are active. Split COM operation is cancelled by pressing the **COM 1/2** Key again, at which time the annunciator is extinguished.

When Split COM operation is selected, COM1 is used by the pilot and COM2 is used by the copilot. The COM1 MIC Annunciator flashes when the pilot's microphone PTT is pressed. The COM2 MIC Annunciator flashes when the copilot's microphone PTT is pressed.

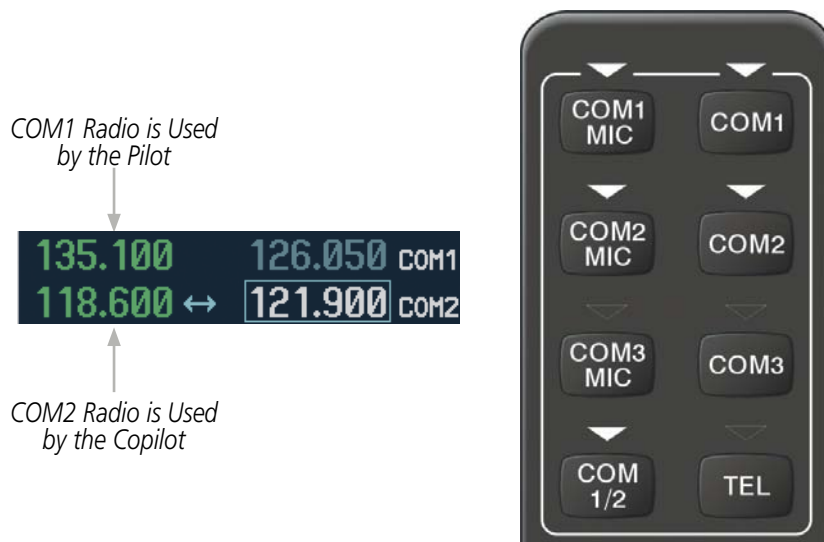

Figure 4-49 Split COM Operation

## Entertainment Inputs



**NOTE:** The entertainment MUSIC INPUT cannot be completely turned off. Audio level for MUSIC INPUT can be adjusted by a Garmin-authorized service center.

The Audio Panel provides a stereo entertainment input from the data link receiver or an MUSIC INPUT jack for the crew and passengers. The MUSIC INPUT jack input is compatible with popular portable entertainment devices such as MP3 and CD players through a 3.5-mm stereo phone jack, installed in a convenient location. The headphone outputs of the entertainment devices are plugged into the MUSIC INPUT jack.

The current ICS state of isolation affects the distribution of the entertainment input (see Table 4-1).

### CREW MUSIC

Music can be heard by the pilot and copilot when both the PILOT and the COPLT ICS Annunciators are extinguished. Music can also be heard by the pilot when the COPLT Annunciator is illuminated and by the copilot when the PILOT Annunciator is illuminated.

#### MUSIC MUTING

Music muting occurs when aircraft radio or marker beacon activity is heard. Music is always soft muted when an interruption occurs from these sources. Soft muting is the gradual return of music to its original volume level. The time required for music volume to return to normal is between one-half and four seconds.

### PASSENGER MUSIC

Music can be heard only by the passengers and is never muted.

### XM RADIO ENTERTAINMENT

XM Radio audio from the Data Link Receiver may be heard by the pilot and passengers simultaneously (optional: requires subscription to XM Radio Service). Refer to the Additional Features Section for more details on the Data Link Receiver.

Connecting a stereo input to the MUSIC INPUT jack removes the XM Radio Audio from that input.

## 4.6 AUDIO PANEL PREFLIGHT PROCEDURE

**NOTE:** If the pilot and/or copilot are using headsets that have a high/low switch or volume control knob, verify that the switch is in the high position and the volume control on the headsets are at maximum volume setting. On single-pilot flights, verify that all other headsets are not connected to avoid excess noise in the audio system.

**NOTE:** When the **MAN SQ** Key is pressed, the ICS squelch can be set manually by the pilot and copilot. If manual squelch is set to full open (SQ annunciated and the knobs turned counterclockwise) background noise is heard in the ICS system as well as during COM transmissions.

After powering up the G1000 System, the following steps aid in maximizing the use of the Audio Panel as well as prevent pilot and copilot induced issues. These preflight procedures should be performed each time a pilot boards the aircraft to insure awareness of all audio levels in the Audio Panel and radios.

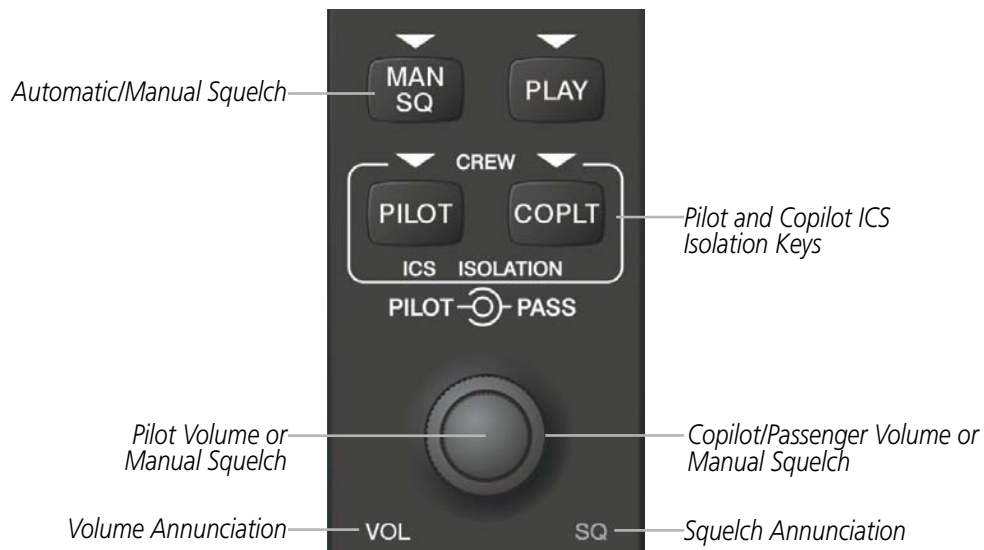

Figure 4-50 Audio Panel Controls

### Setting the Audio Panel during preflight:

- 1) Verify that the PILOT and COPLT Annunciators are extinguished.
- 2) Verify that manual squelch is set to full open.
- 3) Turn the **PILOT/PASS** Knobs clockwise two full turns. This sets the headset intercom audio level to max volume (least amount of attenuation).
- 4) Adjust radio volume levels (COM, NAV, etc.) to a suitable level.
- 5) Adjust the **PILOT/PASS** Knob volume to the desired intercom level.
- 6) Reset squelch to automatic, or adjust to the appropriate level manually.

Once this procedure has been completed, the pilot and copilot can change settings, keeping in mind the notes above.

## 4.7 ABNORMAL OPERATION

Abnormal operation of the G1000 includes equipment failures of the G1000 components and failure of associated equipment, including switches and external devices.

### STUCK MICROPHONE

If the push-to-talk (PTT) Key becomes stuck, the COM transmitter stops transmitting after 35 seconds of continuous operation. An alert appears on the PFD to advise the pilot of a stuck microphone.

The **COM1 MIC** or **COM2 MIC** Key Annunciator on the Audio Panel flashes as long as the PTT Key remains stuck.

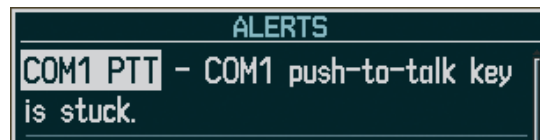

Figure 4-51 Stuck Microphone Alert

### COM TUNING FAILURE

In case of a COM system tuning failure, the emergency frequency (121.500 MHz) is automatically tuned in the radio in which the tuning failure occurred. Depending on the failure mode, a red X may appear on the frequency display.



Figure 4-52 COM Tuning Failure

### AUDIO PANEL FAIL-SAFE OPERATION

If there is a failure of the Audio Panel, a fail-safe circuit connects the pilot's headset and microphone directly to the COM1 transceiver. Audio is not available on the speaker during Fail-safe operation.

### REVERSIONARY MODE

The red **DISPLAY BACKUP** Button selects the Reversionary Mode. See the System Overview Section for more information on Reversionary Mode.



Figure 4-53 Display Backup Button

## SECTION 5 FLIGHT MANAGEMENT

### 5.1 INTRODUCTION

The G1000 is an integrated flight, engine, communication, navigation and surveillance system. This section of the Pilot's Guide explains flight management using the G1000.

The most prominent part of the G1000 are the two full color displays: a Primary Flight Display (PFD) and a Multi Function Display (MFD). The information to successfully navigate the aircraft using the GPS sensors is displayed on the PFD and the MFD. See examples in the Figure 5-1 and Figure 5-2. Detailed descriptions of flight management functions are discussed later in this section.

A brief description of the flight management data on the PFD and MFD follows.

Navigation mode indicates which sensor is providing the course data (e.g., GPS, VOR) and the flight plan phase (e.g., Departure (DPRT), Terminal (TERM), Enroute (ENR), Oceanic (OCN), Approach (LNAV, LNAV+V, L/VNAV, or LPV), or Missed Approach (MAPR)).

The Inset Map is a small version of the MFD Navigation Map and can be displayed in the lower left corner of the PFD. When the system is in reversionary mode, the Inset Map is displayed in the lower right corner. The Inset Map is displayed by pressing the **INSET** Softkey. Selecting the **INSET** Softkey again, then selecting the **OFF** Softkey removes the Inset Map.

The Navigation Map displays aviation data (e.g., airports, VORs, airways, airspaces), geographic data (e.g., cities, lakes, highways, borders), topographic data (map shading indicating elevation), and hazard data (e.g., traffic, terrain, weather). The amount of displayed data can be reduced by selecting the **DCLTR** Softkey. The Navigation Map can be oriented four different ways: North Up (NORTH UP), Track Up (TRK UP), Desired Track Up (DTK UP), or Heading Up (HDG UP).

An aircraft icon is placed on the Navigation Map at the location corresponding to the calculated present position. The aircraft position and the flight plan legs are accurately based on GPS calculations. The basemap upon which these are placed are from a source with less resolution, therefore the relative position of the aircraft to map features is not exact. The leg of the active flight plan currently being flown is shown as a magenta line on the navigation map. The other legs are shown in white.

There are 28 different map ranges available, from 500 feet to 2000 nm. The current range is indicated in the lower right corner of the map and represents the top-to-bottom distance covered by the map. To change the map range on any map, turn the **Joystick** counter-clockwise to zoom in (-, decreasing), or clockwise to zoom out (+, increasing).

The Direct-to Window, the Flight Plan Window, the Procedures Window, and the Nearest Airports Window can be displayed in the lower right corner of the PFD. Details of these windows are discussed in detail later in the section.

- SYSTEM OVERVIEW
- FLIGHT INSTRUMENTS
- EIS
- AUDIO PANEL & CNS
- FLIGHT MANAGEMENT
- HAZARD AVOIDANCE
- AFCS
- ADDITIONAL FEATURES
- APPENDICES
- INDEX



Figure 5-1 GPS Navigation Information on the PFD

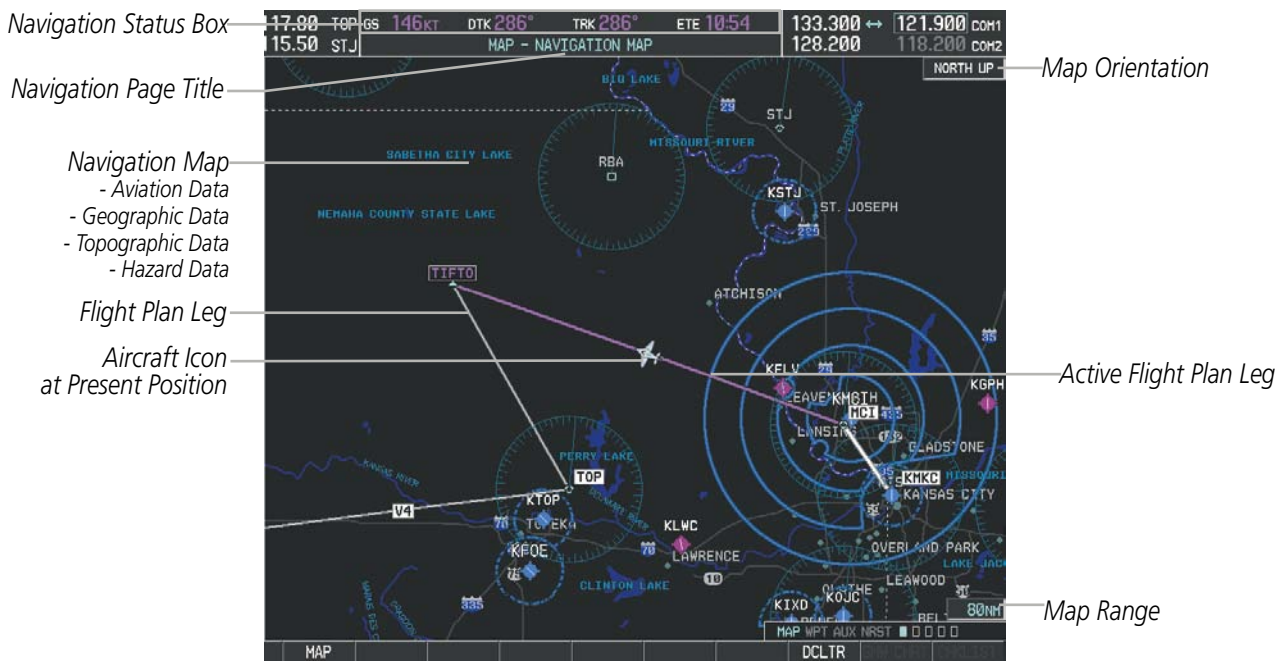

Figure 5-2 GPS Navigation Information on the MFD Navigation Page

## NAVIGATION STATUS BOX

The Navigation Status Box located at the top of the PFD contains two fields displaying the following information:



PFD Navigation Status Box

- Active flight plan leg (e.g., ‘D-> KICT’ or ‘KIXD -> KCOS’) **or** flight plan annunciations (e.g., ‘Turn right to 021° in 8 seconds’)
- Distance (DIS) and Bearing (BRG) to the next waypoint **or** flight plan annunciations (e.g., ‘TOD within 1 minute’)

The symbols used in the PFD status bar are:

Symbol	Description
	Active Leg
	Direct-to
	Right Procedure Turn
	Left Procedure Turn
	Right Holding Pattern
	Left Holding Pattern
	Vector to Final
	Right DME Arc
	Left DME Arc

The Navigation Status Box located at the top of the MFD contains four data fields, each displaying one of the following items:

- Bearing (BRG)
- Distance (DIS)
- Desired Track (DTK)
- Endurance (END)
- Enroute Safe Altitude (ESA)
- Estimated Time of Arrival (ETA)
- Estimated Time Enroute (ETE)
- Fuel on Board (FOB)
- Fuel over Destination (FOD)
- Ground Speed (GS)
- Minimum Safe Altitude (MSA)
- True Air Speed (TAS)
- Track Angle Error (TKE)
- Track (TRK)
- Vertical Speed Required (VSR)
- Crosstrack Error (XTK)



MFD Navigation Status Box

The navigation information displayed in the four data fields can be selected on the MFD Data Bar Fields Box on the AUX - System Setup Page. The default selections (in order left to right) are GS, DTK, TRK, and ETE.

**Changing a field in the MFD Navigation Status Box:**

- 1) Select the System Setup Page.
- 2) Press the **FMS** Knob momentarily to activate the flashing cursor.
- 3) Turn the large **FMS** Knob to highlight the desired field number in the MFD Data Bar Fields Box.
- 4) Turn the small **FMS** Knob to display and scroll through the data options list.
- 5) Select the desired data.
- 6) Press the **ENT** Key. Pressing the **DFLTS** Softkey returns all fields to the default setting.



## 5.2 USING MAP DISPLAYS

Map displays are used extensively in the G1000 to provide situational awareness in flight. Most G1000 maps can display the following information:

- Airports, NAVAIDs, airspaces, airways, land data (highways, cities, lakes, rivers, borders, etc.) with names
- Map Pointer information (distance and bearing to pointer, location of pointer, name, and other pertinent information)
- Map range
- Wind direction and speed
- Map orientation
- Icons for enabled map features
- Aircraft icon (representing present position)
- Nav range ring
- Fuel range ring
- Flight plan legs
- User waypoints
- Track vector
- Topography scale
- Topography data
- Obstacle data

The information in this section applies to the following maps unless otherwise noted:

- All Map Group Pages (MAP)
- All Waypoint Group Pages (WPT)
- AUX - Trip Planning
- All Nearest Group Pages (NRST)
- Flight Plan Pages (FPL)
- Direct-to Window
- PFD Inset Map
- Procedure Loading Pages

### MAP ORIENTATION

Maps are shown in one of four different orientation options, allowing flexibility in determining aircraft position relative to other items on the map (north up) or for determining where map items are relative to where the aircraft is going (track up, desired track up, or heading up). The map orientation is shown in the upper right corner of the map.



Figure 5-3 Map Orientation

- North up (NORTH UP) aligns the top of the map display to north (default setting).
- Track up (TRK UP) aligns the top of the map display to the current ground track.
- Desired track up (DTK UP) aligns the top of the map display to the desired course.
- Heading up (HDG UP) aligns the top of the map display to the current aircraft heading.

**NOTE:** When panning or reviewing active flight plan legs in a non-North Up orientation, the map does not show the map orientation nor the wind direction and speed.

**NOTE:** Map orientation can only be changed on the Navigation Map Page. Any other displays that show navigation data reflect the orientation selected for the Navigation Map Page.

**Changing the Navigation Map orientation:**

- 1) With the Navigation Map Page displayed, press the **MENU** Key. The cursor flashes on the 'Map Setup' option.



**Figure 5-4 Navigation Map Page Menu Window**

- 2) Select the **ENT** Key to display the Map Setup Window.
- 3) Turn the large **FMS** Knob, or select the **ENT** Key once, to select the 'ORIENTATION' field.

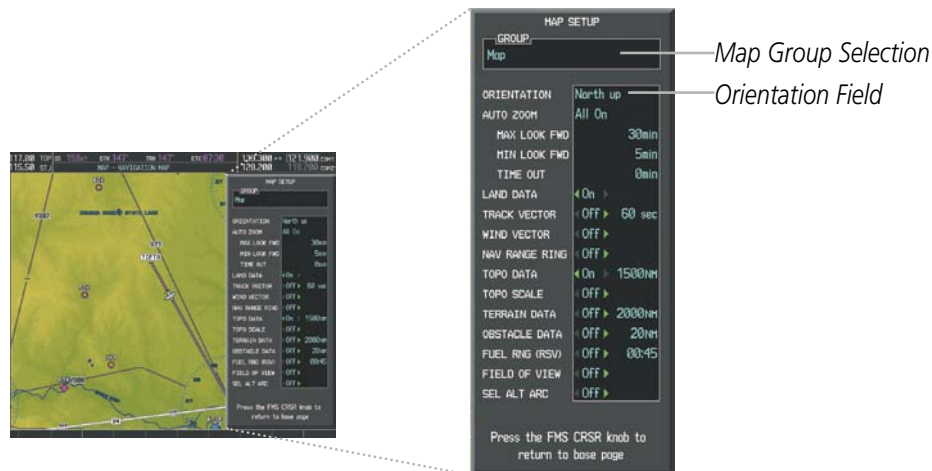

**Figure 5-5 Map Setup Menu Window - Map Group**

- 4) Turn the small **FMS** Knob to select the desired orientation.
- 5) Select the **ENT** Key to select the new orientation.
- 6) Press the **FMS** Knob to return to the base page.

## MAP RANGE

There are 28 different map ranges available, from 500 feet to 2000 nm. The current range is indicated in the lower right corner of the map and represents the top-to-bottom distance covered by the map. When the map range is decreased to a point that exceeds the capability of the G1000 to accurately represent the map, a magnifying glass icon is shown to the left of the map range. To change the map range turn the **Joystick** counter-clockwise to decrease the range, or clockwise to increase the range.



Figure 5-6 Map Range

## AUTO ZOOM

Auto zoom allows the G1000 to change the map display range to the smallest range clearly showing the active waypoint. Auto zoom can be overridden by adjusting the range with the Joystick, and remains until the active waypoint changes, a terrain or traffic alert occurs, the aircraft takes off, or the manual override times out (timer set on Map Setup Window).

If a terrain caution or warning occurs, any map page displaying TAWS/TERRAIN data automatically adjusts to the smallest map range clearly showing the highest priority alert. If a new traffic advisory alert occurs, any map page capable of displaying traffic advisory alerts automatically adjusts to the smallest map range clearly showing the traffic advisory. When terrain or traffic alerts clear, the map returns to the previous auto zoom range based on the active waypoint.

The auto zoom function can be turned on or off independently for the PFDs and MFD. Control of the ranges at which the auto zoom occurs is done by setting the minimum and maximum ‘look forward’ times (set on the Map Setup Window for the Map Group). These settings determines the minimum and maximum distance to display based upon the aircraft’s ground speed.

- Waypoints that are long distances apart cause the map range to increase to a point where many details on the map are decluttered. If this is not acceptable, lower the maximum look ahead time to a value that limits the auto zoom to an acceptable range.
- Waypoints that are very short distances apart cause the map range to decrease to a point where situational awareness may not be what is desired. Increase the minimum look ahead time to a value that limits the auto zoom to a minimum range that provides acceptable situational awareness.
- Flight plans that have a combination of long and short legs cause the range to increase and decrease as waypoints sequence. To avoid this, auto zoom can be disabled or the maximum/minimum times can be adjusted.

- The 'time out' time (configurable on the Map Setup Page for the Map Group) determines how long auto zoom is overridden by a manual adjustment of the range knob. At the expiration of this time, the auto zoom range is restored. Setting the 'time out' value to zero causes the manual override to never time out.
- When the maximum 'look forward' time is set to zero, the upper limit becomes the maximum range available (2000 nm).
- When the minimum 'look forward' time is set to zero, the lower limit becomes 1.5 nm.

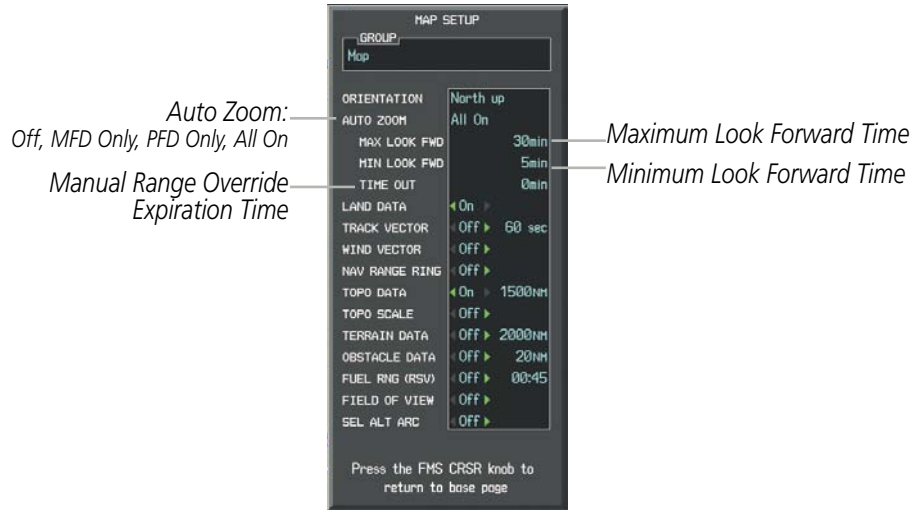

**Figure 5-7 Map Setup Menu Window - Map Group, Auto Zoom**

**Configuring automatic zoom:**

- 1) Press the **MENU** Key with the Navigation Map Page displayed. The cursor flashes on the 'Map Setup' option.
- 2) Press the **ENT** Key. The Map Setup Menu is displayed.
- 3) Select the 'Map' group.
- 4) Press the **ENT** Key.
- 5) Highlight the 'AUTO ZOOM' field.
- 6) Select 'Off', 'MFD Only', 'PFD Only', or 'ALL On'.
- 7) Press the **ENT** Key to accept the selected option. The flashing cursor highlights the 'MAX LOOK FWD' field. Times are from zero to 999 minutes.
- 8) Use the **FMS** Knobs to set the time. Press the **ENT** Key.
- 9) Repeat step 8 for 'MIN LOOK FWD' (zero to 99 minutes) and 'TIME OUT' (zero to 99 minutes).
- 10) Press the **FMS** Knob to return to the Navigation Map Page.

## MAP PANNING

Map panning allows the pilot to:

- View parts of the map outside the displayed range without adjusting the map range
- Highlight and select locations on the map
- Review information for a selected airport, NAVAID or user waypoint
- Designate locations for use in flight planning
- View airspace and airway information

When the panning function is selected by pressing the **Joystick**, the Map Pointer flashes on the map display. A window also appears at the top of the map display showing the latitude/longitude position of the pointer, the bearing and distance to the pointer from the aircraft's present position, and the elevation of the land at the position of the pointer.

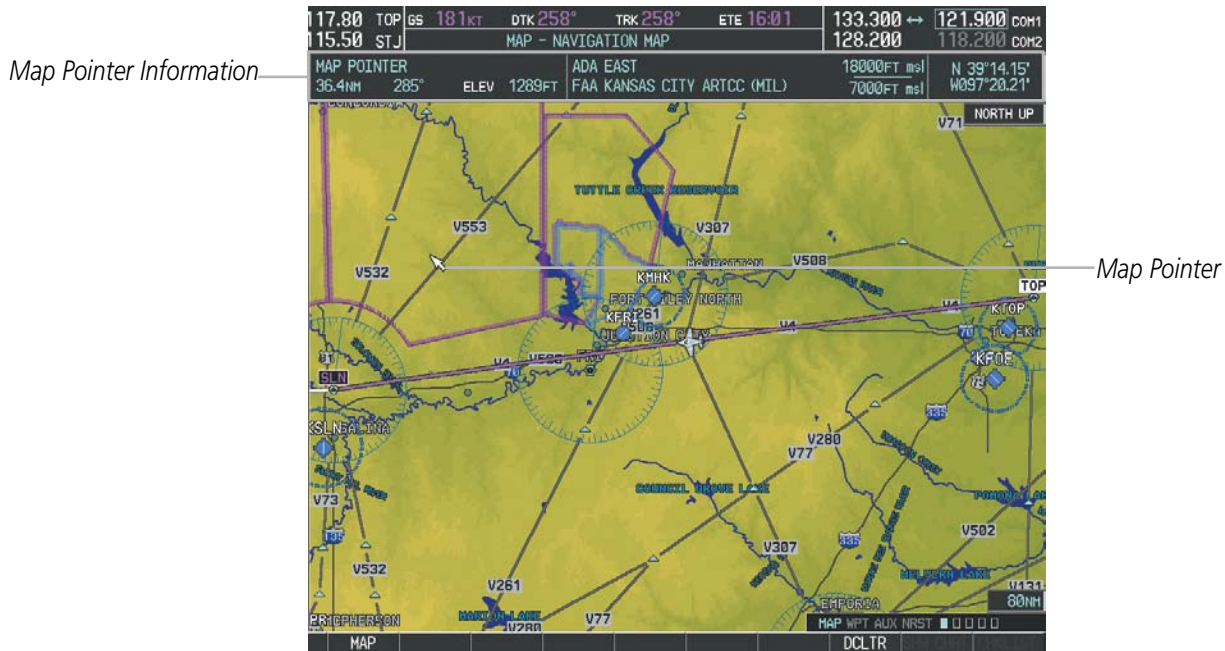

Figure 5-8 Navigation Map - Map Pointer Activated



**NOTE:** The map is normally centered on the aircraft's position. If the map has been panned and there has been no pointer movement for about 60 seconds, the map reverts back to centered on the aircraft position and the flashing pointer is removed.

When the Map Pointer is placed on an object, the name of the object is highlighted (even if the name was not originally displayed on the map). When any map feature or object is selected on the map display, pertinent information is displayed.

Information about Point of Interest



Map Pointer on POI

Figure 5-9 Navigation Map - Map Pointer on Point of Interest



When the Map Pointer crosses an airspace boundary, the boundary is highlighted and airspace information is shown at the top of the display. The information includes the name and class of airspace, the ceiling in feet above Mean Sea Level (MSL), and the floor in feet MSL.



Figure 5-10 Navigation Map - Map Pointer on Airspace

**Panning the map:**

- 1) Press the **Joystick** to display the Map Pointer.
- 2) Move the **Joystick** to move the Map Pointer around the map.
- 3) Press the **Joystick** to remove the Map Pointer and recenter the map on the aircraft's current position.



Reviewing information for an airport, NAVAID, or user waypoint:

- 1) Place the Map Pointer on a waypoint.
- 2) Press the **ENT** Key to display the Waypoint Information Page for the selected waypoint.
- 3) Press the **GO BACK** Softkey, the **CLR** Key, or the **ENT** Key to exit the Waypoint Information Page and return to the Navigation Map showing the selected waypoint.

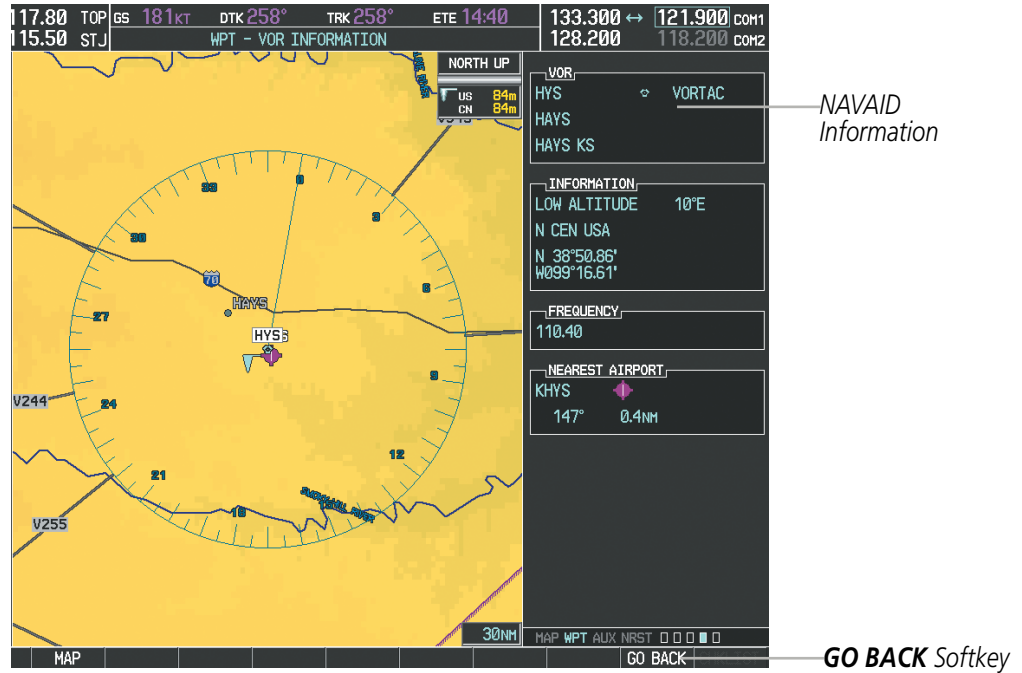

Figure 5-11 Navigation Map - Information Window - NAVAID

**Viewing airspace information for a special-use or controlled airspace:**

- 1) Place the Map Pointer on an open area within the boundaries of an airspace.
- 2) Press the **ENT** Key to display an options menu.
- 3) 'Review Airspaces' should already be highlighted, if not select it. Press the **ENT** Key to display the Airspace Information Page for the selected airspace.
- 4) Press the **CLR** or **ENT** Key to exit the Airspace Information Page.



Figure 5-12 Navigation Map - Information Window - Airspace

## MEASURING BEARING AND DISTANCE

Distance and bearing from the aircraft's present position to any point on the viewable navigation map may be calculated using the 'Measure Bearing and Distance' selection from Navigation Map page menu. The bearing and distance tool displays a dashed Measurement Line and a Measure Pointer to aid in graphically identifying points with which to measure. Lat/Long, distance and elevation data for the Measure Pointer is provided in a window at the top of the navigation map.

### Measuring bearing and distance between any two points:

- 1) Press the **MENU** Key (with the Navigation Map Page displayed).
- 2) Highlight the 'Measure Bearing/Distance' field.
- 3) Press the **ENT** Key. A Measure Pointer is displayed on the map at the aircraft's present position.
- 4) Move the **Joystick** to place the reference pointer at the desired location. The bearing and distance are displayed at the top of the map. Elevation at the current pointer position is also displayed. Pressing the **ENT** Key changes the starting point for measuring.
- 5) To exit the Measure Bearing/Distance option, press the **Joystick**; or select 'Stop Measuring' from the Page Menu and press the **ENT** Key.



Figure 5-13 Navigation Map - Measuring Bearing and Distance

## TOPOGRAPHY

All navigation maps can display various shades of topography colors representing land elevation, similar to aviation sectional charts. Topographic data can be displayed or removed as described in the following procedures. Topographic data can also be displayed on the selectable profile map at the bottom of the navigation map.

### Displaying/removing Profile View

- 1) From the Navigation Map Page, press the **MAP** Softkey.
  - 2) Press the **PROFILE** Softkey to enable or disable Profile View.
- Or:
- 1) Press the **MENU** Key.
  - 2) Select 'Show Profile View' or 'Hide Profile View' and press the **ENT** Key.

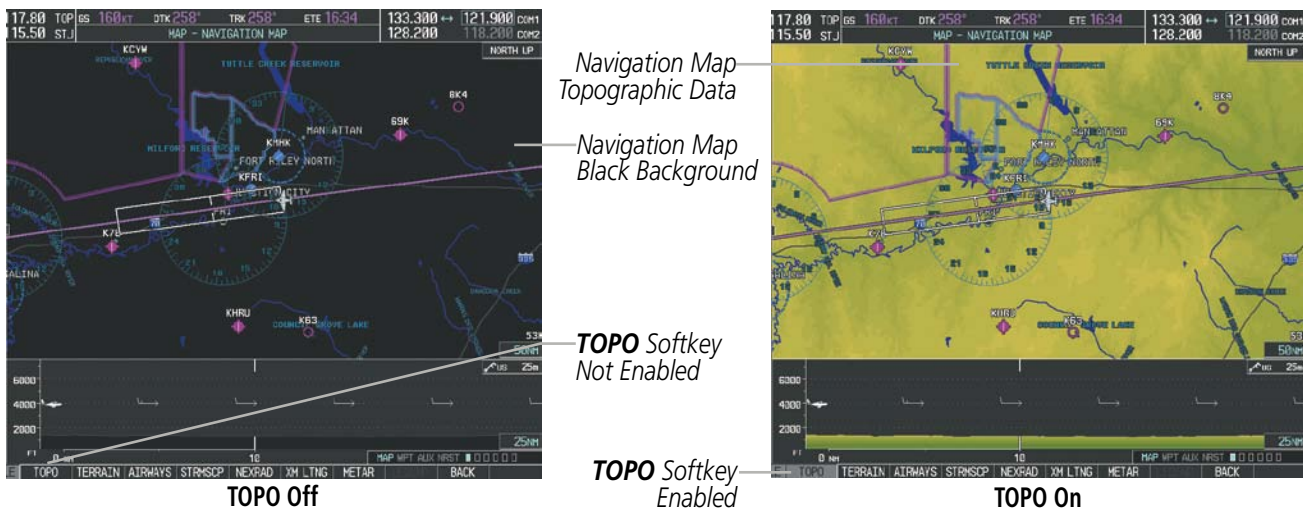

Figure 5-14 Navigation Map - Topographic Data

### Displaying/removing topographic data on all pages displaying navigation maps:

- 1) Press the **MAP** Softkey (the **INSET** Softkey for the PFD Inset Map).
- 2) Press the **TOPO** Softkey.
- 3) Press the **TOPO** Softkey again to remove topographic data from the Navigation Map. When topographic data is removed from the page, all navigation data is presented on a black background.

### Displaying/removing topographic data (TOPO DATA) using the Navigation Map Page Menu:

- 1) Press the **MENU** Key with the Navigation Map Page displayed. The cursor flashes on the 'Map Setup' option.
- 2) Press the **ENT** Key. The Map Setup Menu is displayed.
- 3) Select the 'Map' group.
- 4) Press the **ENT** Key.

- 5) Highlight the 'TOPO DATA' field.
- 6) Select 'On' or 'Off'.
- 7) Press the **FMS** Knob to return to the Navigation Map Page.

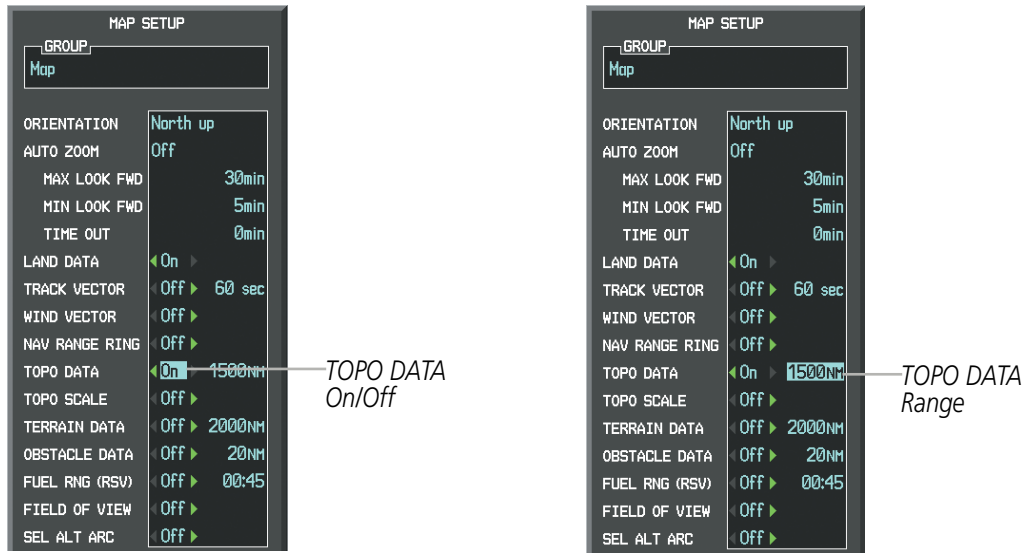

Figure 5-15 Navigation Map Setup Menu - TOPO DATA Setup

The topographic data range is the maximum map range on which topographic data is displayed.



**NOTE:** Since the PFD Inset Map is much smaller than the MFD navigation maps, items are removed on the PFD Inset Map two range levels smaller than the range selected in the Map Setup pages (e.g., a setting of 100 nm removes the item at ranges above 100 nm on MFD navigation maps, while the PFD Inset Map removes the same item at 50 nm).

**Selecting a topographical data range (TOPO DATA):**

- 1) Press the **MENU** Key with the Navigation Map Page displayed. The cursor flashes on the 'Map Setup' option.
- 2) Press the **ENT** Key. The Map Setup Menu is displayed.
- 3) Select the 'Map' group.
- 4) Press the **ENT** Key.
- 5) Highlight the 'TOPO DATA' range field. TOPO ranges are from 500 ft to 2000 nm.
- 6) To change the TOPO range setting, turn the small **FMS** Knob to display the range list.
- 7) Select the desired range using the small **FMS** Knob.
- 8) Press the **ENT** Key.
- 9) Press the **FMS** Knob to return to the Navigation Map Page.

In addition, the Navigation Map can display a topographic scale (located in the lower right hand side of the map) showing a scale of the terrain elevation and current elevation values.

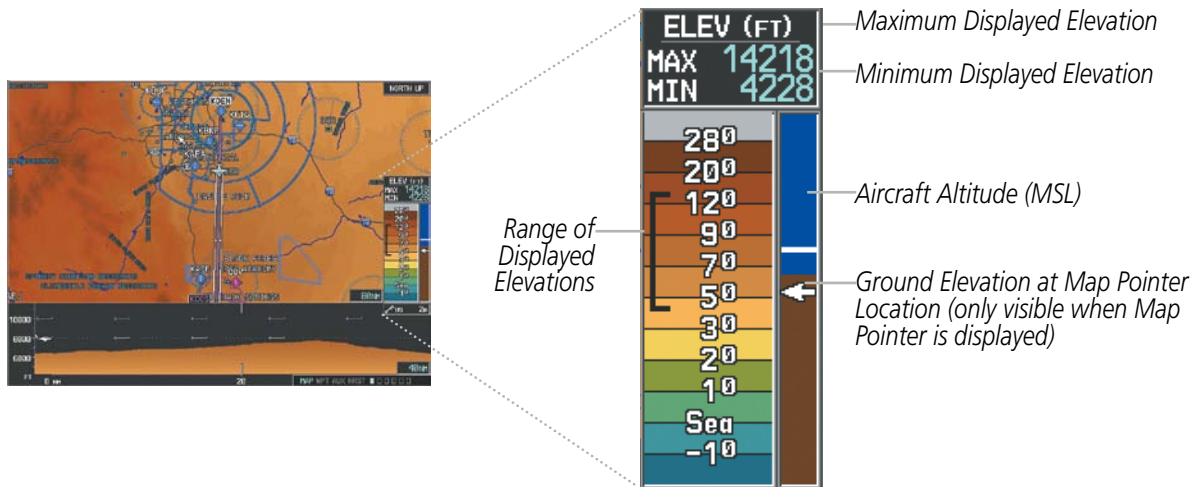

Figure 5-16 Navigation Map - TOPO SCALE

**Displaying/removing the topographic scale (TOPO SCALE):**

- 1) Press the **MENU** Key with the Navigation Map Page displayed. The cursor flashes on the 'Map Setup' option.
- 2) Press the **ENT** Key. The Map Setup Menu is displayed.
- 3) Select the 'Map' group and select the **ENT** Key.
- 4) Highlight the 'TOPO SCALE' field.
- 5) Select 'On' or 'Off'.
- 6) Press the **FMS** Knob to return to the Navigation Map Page.

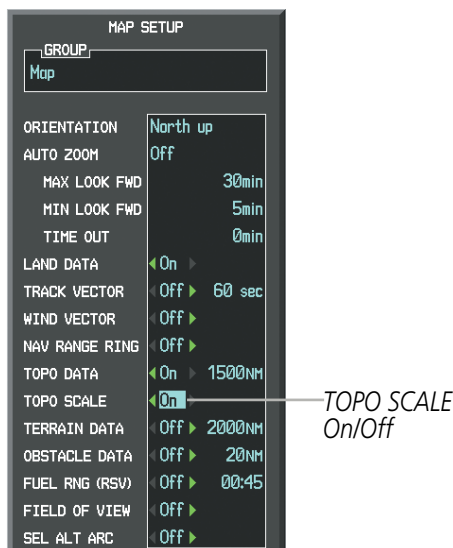

Figure 5-17 Navigation Map Setup Menu - TOPO SCALE Setup



## MAP SYMBOLS

This section discusses the types of land and aviation symbols that can be displayed. Each listed type of symbol can be turned on or off, and the maximum range to display each symbol can be set. The decluttering of the symbols from the map using the **DCLTR** Softkey is also discussed.

### LAND SYMBOLS

The following items are configured on the land menu:













Land Symbols <i>(Text label size can be None, Small, Medium (Med), or Large (Lrg))</i>	Symbol	Default Range (nm)	Maximum Range (nm)
Latitude/Longitude (LAT/LON)		Off	2000
Highways and Roads			
Interstate Highway (FREEWAY)		300	800
International Highway (FREEWAY)		300	800
US Highway (NATIONAL HWY)		30	80
State Highway (LOCAL HWY)		15	30
Local Road (LOCAL ROAD)	N/A	8	15
Railroads (RAILROAD)		15	30
LARGE CITY (> 200,000)		800	1500
MEDIUM CITY (> 50,000)		100	200
SMALL CITY (> 5,000)		20	50
States and Provinces (STATE/PROV)		800	1500
Rivers and Lakes (RIVER/LAKE)		200	500
USER WAYPOINT		150	300

Table 5-1 Land Symbol Information



## AVIATION SYMBOLS

The following items are configured on the aviation menu:

Aviation Symbols <i>(Text label size can be None, Small, Medium (Med), or Large (Lrg))</i>	Symbol	Default Range (nm)	Maximum Range (nm)
Active Flight Plan Leg (ACTIVE FPL)		2000	2000
Non-active Flight Plan Leg (ACTIVE FPL)		2000	2000
Active Flight Plan Waypoint (ACTIVE FPL WPT)	See Airports, NAVAIDs	2000	2000
Large Airports (LARGE APT)		250	500
Medium Airports (MEDIUM APT)		150	300
Small Airports (SMALL APT)		50	100
Taxiways (SAFETAXI)	See Additional Features	3	20
Runway Extension (RWY EXTENSION)	N/A	Off	100
Intersection (INT WAYPOINT)		15	30
Non-directional Beacon (NDB WAYPOINT)		15	30
VOR (VOR WAYPOINT)		150	300
Class B Airspace/TMA (CLASS B/TMA)		200	500
Class C Airspace/TCA (CLASS C/TCA)		200	500
Class D Airspace (CLASS D)		150	300
Restricted Area (RESTRICTED)		200	500
Military Operations Area [MOA(MILITARY)]		200	500
Other/Air Defense Interdiction Zone (OTHER/ADIZ)		200	500
Temporary Flight Restriction (TFR)		500	2000

Table 5-2 Aviation Symbol Information

## SYMBOL SETUP

All pages with maps can display land symbols (roads, lakes, borders, etc). Land symbols can be removed totally (turned off).

### Displaying/removing all land symbols:

- 1) Press the **MENU** Key with the Navigation Map Page displayed. The Page Menu is displayed and the cursor flashes on the 'Map Setup' option.
- 2) Press the **ENT** Key. The Map Setup Group Menu is displayed and the cursor flashes on the 'Map' option.
- 3) Highlight the 'LAND DATA' field.
- 4) Select 'On' or 'Off'.
- 5) Press the **FMS** Knob to return to the Navigation Map Page.

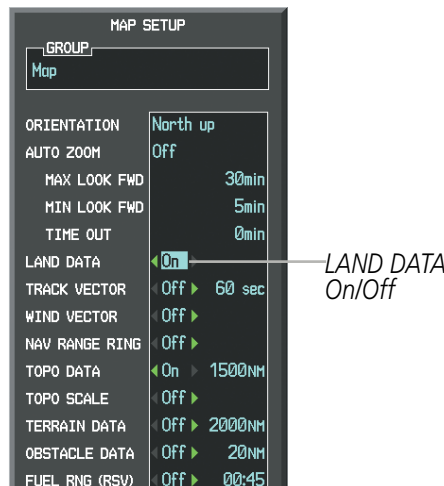

Figure 5-18 Navigation Map Setup Menu - LAND DATA Setup

The label size (TEXT) sets the size at which labels appear on the display (none, small, medium, and large). The range (RNG) sets the maximum range at which items appear on the display.

### Selecting a 'Land' or 'Aviation' group item text size and range:

- 1) Press the **MENU** Key with the Navigation Map Page displayed. The cursor flashes on the 'Map Setup' option.
- 2) Press the **ENT** Key. The Map Setup Menu is displayed.
- 3) Select the 'Land' or 'Aviation' group.
- 4) Press the **ENT** Key. The cursor flashes on the first field.
- 5) Select the desired land option.
- 6) Select the desired text size.
- 7) Press the **ENT** Key to accept the selected size.
- 8) Select the desired range.
- 9) Press the **ENT** Key to accept the selected range.
- 10) Press the **FMS** Knob to return to the Navigation Map Page.

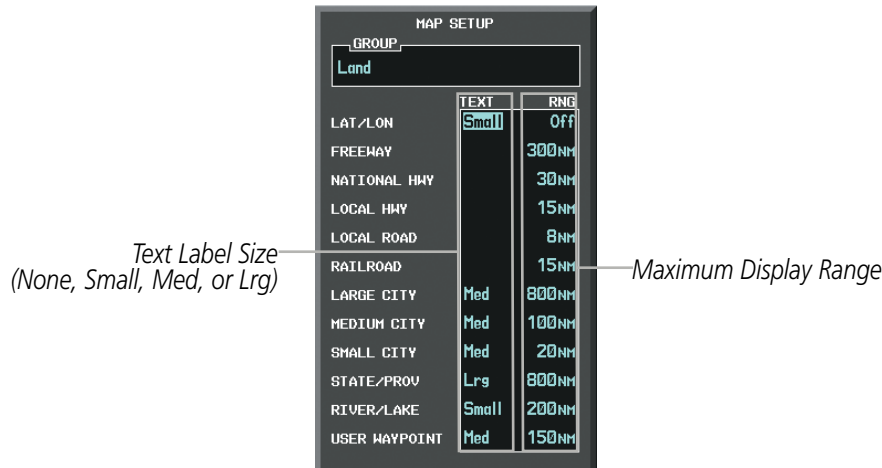

Figure 5-19 Navigation Map Setup Menu - LAND GROUP Setup

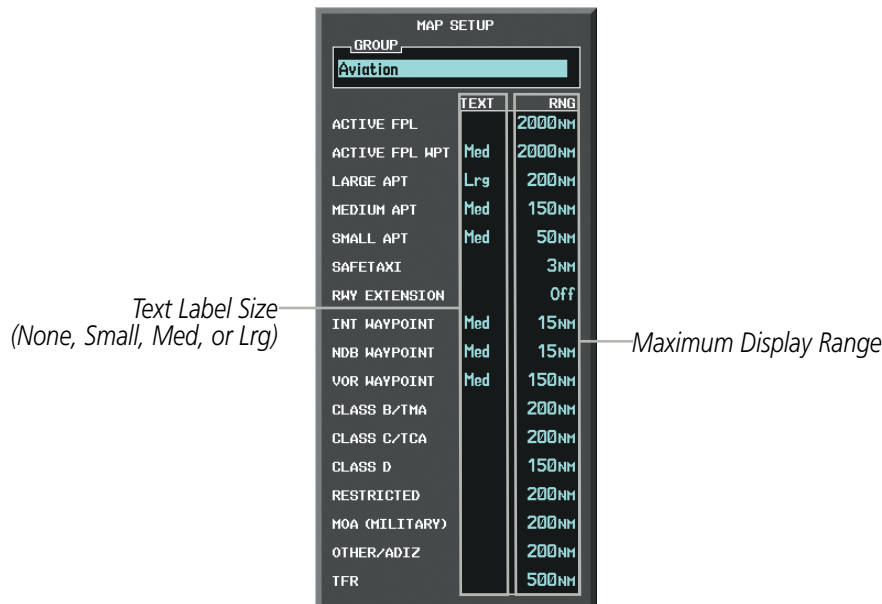

Figure 5-20 Navigation Map Setup Menu - AVIATION GROUP Setup



**NOTE:** Since the PFD Inset Map is much smaller than the MFD navigation maps, items are removed on the PFD Inset Map two range levels smaller than the range selected in the Map Setup pages (e.g., a setting of 100 nm removes the item at ranges above 100 nm on MFD navigation maps, while the PFD Inset Map removes the same item at 50 nm).

## MAP DECLUTTER

The declutter feature allows the pilot to progressively step through four levels of removing map information. The declutter level is displayed in the **DCLTR** Softkey and next to the Declutter Menu Option.

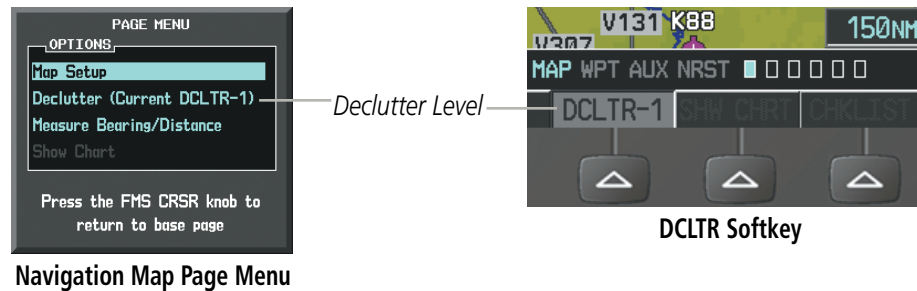

Figure 5-21 Navigation Map - Declutter Level Indications

### Decluttering the map:

Select the **DCLTR** Softkey with the Navigation Map Page displayed. The current declutter level is shown. With each softkey selection, another level of map information is removed.

Or:

- 1) Press the **MENU** Key with the Navigation Map Page displayed.
- 2) Select 'Declutter'. The current declutter level is shown.
- 3) Press the **ENT** Key.

### Decluttering the PFD Inset Map:

- 1) Press the **INSET** Softkey.
- 2) Select the **DCLTR** Softkey. The current declutter level is shown. With each selection, another level of map information is removed.

Table 5-3 lists the items displayed at each declutter level. The 'X' represents map items displayed for the various levels of declutter.

Item	No Declutter	Declutter-1	Declutter-2	Declutter-3
Flight Plan Route Lines	X	X	X	X
Flight Plan Route Waypoints	X	X	X	X
Rivers/Lakes	X	X	X	X
Topography Data	X	X	X	X
International Borders	X	X	X	X
Track Vector	X	X	X	X
Navigation Range Ring	X	X	X	X
Fuel Range Ring	X	X	X	X
Terrain Data	X	X	X	X
Traffic	X	X	X	X
Airways	X	X	X	X
NEXRAD	X	X	X	
XM Lightning Data	X	X	X	
Airports	X	X	X	
Runway Labels	X	X	X	
Restricted	X	X	X	
MOA (Military)	X	X	X	
User Waypoints	X	X		
Latitude/Longitude Grid	X	X		
NAVAIDs	X	X		
Class B Airspaces/TMA	X	X		
Class C Airspaces/TCA	X	X		
Class D Airspaces	X	X		
Other Airspaces/ADIZ	X	X		
TFRs	X	X		
Obstacles	X	X		
Land/Country Text	X			
Cities	X			
Roads	X			
Railroads	X			
State/Province Boundaries	X			
River/Lake Names	X			

Table 5-3 Navigation Map Items Displayed by Declutter Level

SYSTEM OVERVIEW

FLIGHT INSTRUMENTS

EIS

AUDIO PANEL & CNS

FLIGHT MANAGEMENT

HAZARD AVOIDANCE

AFCS

ADDITIONAL FEATURES

APPENDICES

INDEX

**AIRWAYS**

This airways discussion is based upon the North American airway structure. The airway structure in places other than North America vary by location, etc. and are not discussed in this book. Low Altitude Airways (or Victor Airways) primarily serve smaller piston-engine, propeller-driven airplanes on shorter routes and at lower altitudes. Airways are eight nautical miles wide and start 1,200 feet above ground level (AGL) and extend up to 18,000 feet mean sea level (MSL). Low Altitude Airways are designated with a “V” before the airway number (hence the name “Victor Airways”) since they run primarily between VORs.

High Altitude Airways (or Jet Routes) primarily serve airliners, jets, turboprops, and turbocharged piston aircraft operating above 18,000 feet MSL. Jet Routes start at 18,000 feet MSL and extend upward to 45,000 feet MSL (altitudes above 18,000 feet are called “flight levels” and are described as FL450 for 45,000 feet MSL). Jet Routes are designated with a “J” before the route number.

Low Altitude Airways are drawn in gray (the same shade used for roads). High Altitude Airways are drawn in green. When both types of airways are displayed, High Altitude Airways are drawn on top of Low Altitude Airways.

When airways are selected for display on the map, the airway waypoints (VORs, NDBs and Intersections) are also displayed.

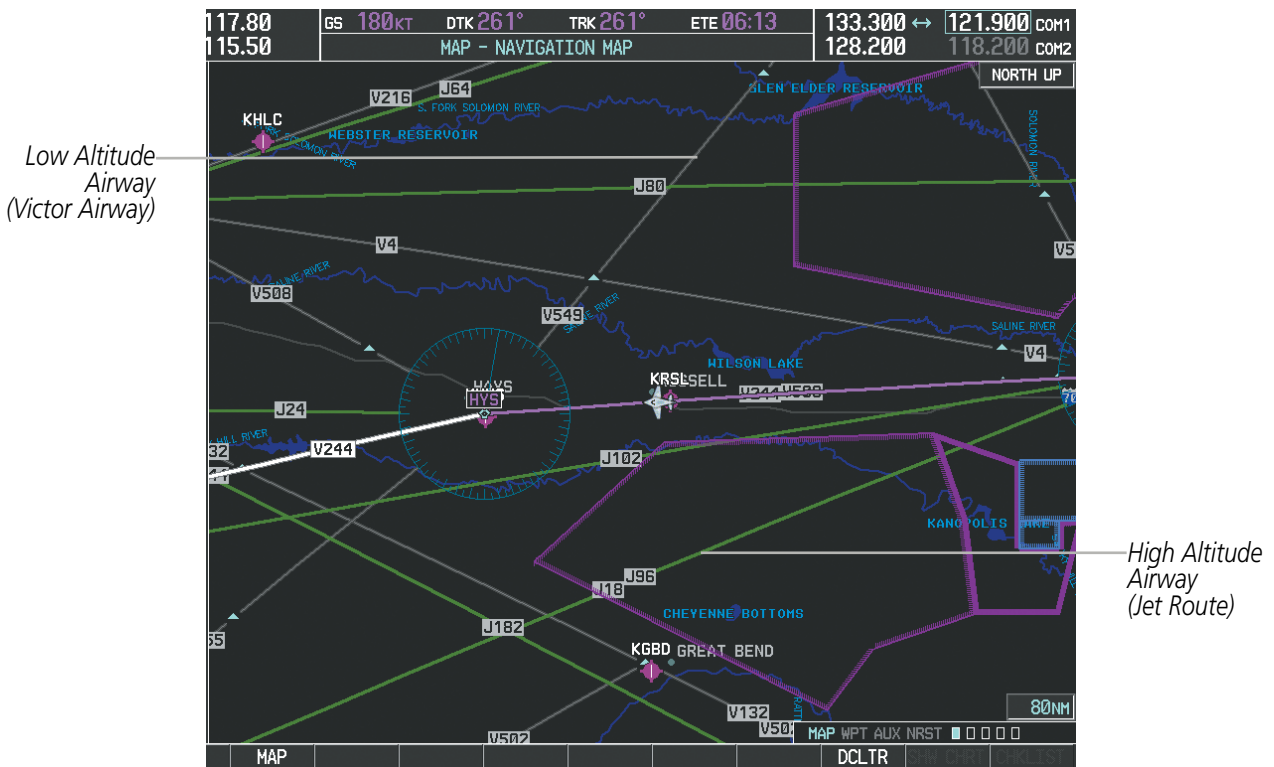

Figure 5-22 Airways on MFD Navigation Page

- SYSTEM OVERVIEW
- FLIGHT INSTRUMENTS
- EIS
- AUDIO PANEL & CNS
- FLIGHT MANAGEMENT
- HAZARD AVOIDANCE
- AFCS
- ADDITIONAL FEATURES
- APPENDICES
- INDEX

Airways may be displayed on the map at the pilot's discretion using either a combination of **AIRWAYS** Softkey presses, or menu selections using the **MENU** Key from the Navigation Map Page. The Airway range can also be programmed to only display Airways on the MFD when the map range is at or below a specific number.

**Displaying/removing airways:**

- 1) Select the **MAP** Softkey.
- 2) Select the **AIRWAYS** Softkey. Both High and Low Altitude Airways are displayed (AIRWY ON).
- 3) Select the softkey again to display Low Altitude Airways only (AIRWY LO).
- 4) Select the softkey again to display High Altitude Airways only (AIRWY HI).
- 5) Select the softkey again to remove High Altitude Airways. No airways are displayed (AIRWAYS).

Or:

- 1) Press the **MENU** Key with the Navigation Map Page displayed. The cursor flashes on the 'Map Setup' option.
- 2) Press the **ENT** Key. The Map Setup Menu is displayed.
- 3) Turn the small **FMS** Knob to select the 'Airways' group, and press the **ENT** Key.
- 4) Turn the large **FMS** Knob to highlight the 'AIRWAYS' field.
- 5) Turn the **FMS** Knob to select 'Off', 'All', 'LO Only', or 'HI Only', and press the **ENT** Key.
- 6) Press the **FMS** Knob to return to the Navigation Map Page.

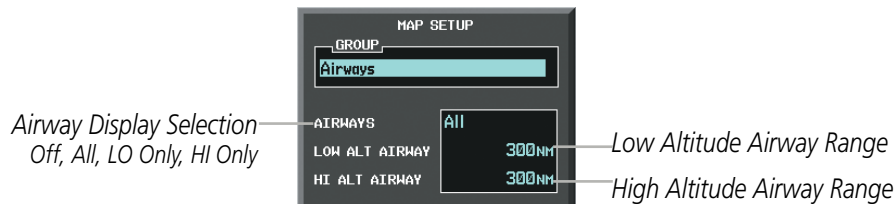

**Figure 5-23 Navigation Map Setup Menu - AIRWAYS Setup**



The airway range is the maximum map range on which airways are displayed.

**Selecting an airway range (LOW ALT AIRWAY or HI ALT AIRWAY):**

- 1) Press the **MENU** Key with the Navigation Map Page displayed. The cursor flashes on the 'Map Setup' option.
- 2) Press the **ENT** Key. The Map Setup Menu is displayed.
- 3) Turn the small **FMS** Knob to select the 'Airways' group and press the **ENT** Key.
- 4) Highlight the 'LOW ALT AIRWAY' or 'HI ALT AIRWAY' range field.
- 5) To change the range setting, turn the small **FMS** Knob to display the range list.
- 6) Select the desired range using the small **FMS** Knob.
- 7) Press the **ENT** Key.
- 8) Press the **FMS** Knob to return to the Navigation Map Page.



The following range items are configurable on the airways menu:

Airway Type	Symbol	Default Range (nm)	Maximum Range (nm)
Low Altitude Airway (LOW ALT AIRWAY)		200	500
High Altitude Airway (HI ALT AIRWAY)		300	500

**Table 5-4 Airway Range Information**

**TRACK VECTOR**

The Navigation Map can display a track vector that is useful in minimizing track angle error. The track vector is a solid light blue line segment extended to a predicted location. The track vector look-ahead time is selectable (30 sec, 60 sec (default), 2 min, 5 min, 10 min, 20 min) and determines the length of the track vector. The track vector shows up to 90 degrees of a turn for the 30 and 60 second time settings.

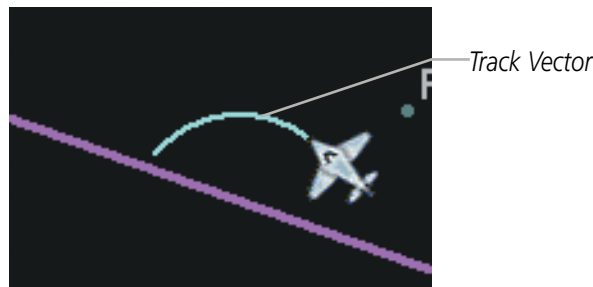

**Figure 5-24 Navigation Map -Track Vector**

**Displaying/removing the track vector:**

- 1) Press the **MENU** Key with the Navigation Map Page displayed. The cursor flashes on the 'Map Setup' option.
- 2) Press the **ENT** Key. The Map Setup Menu is displayed.
- 3) Select the 'Map' group.
- 4) Press the **ENT** Key.
- 5) Highlight the 'TRACK VECTOR' field.
- 6) Select 'On' or 'Off'. Press the **ENT** Key to accept the selected option. The flashing cursor highlights the look ahead time field. Use the **FMS** Knob to select the desired time. Press the **ENT** Key.
- 7) Press the **FMS** Knob to return to the Navigation Map Page.

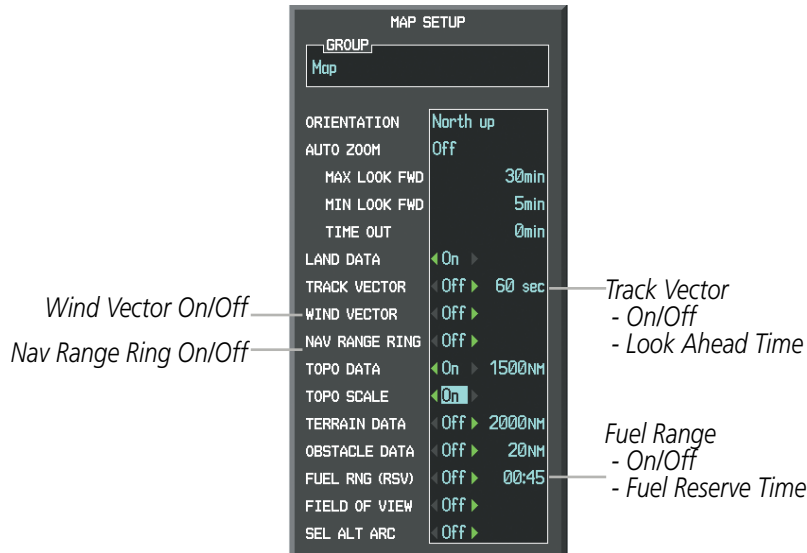

Figure 5-25 Navigation Map Setup Menu -TRACK VECTOR, WIND VECTOR, NAV RANGE RING, FUEL RANGE RING Setup

## WIND VECTOR

The map displays a wind vector arrow in the upper right-hand portion of the screen. Wind vector information is displayed as a white arrow pointing in the direction in which the wind is moving for wind speeds greater than or equal to 1 kt.



Figure 5-26 Navigation Map - Wind Vector



**NOTE:** The wind vector is not displayed until the aircraft is moving. It is not displayed on the Waypoint Information pages.

### Displaying/removing the wind vector:

- 1) Press the **MENU** Key with the Navigation Map Page displayed. The cursor flashes on the 'Map Setup' option.
- 2) Press the **ENT** Key. The Map Setup Menu is displayed.
- 3) Select the 'Map' group.
- 4) Press the **ENT** Key.
- 5) Highlight the 'WIND VECTOR' field.
- 6) Select 'On' or 'Off'.
- 7) Press the **FMS** Knob to return to the Navigation Map Page.

## NAV RANGE RING

The Nav Range Ring shows the direction of travel (ground track) on a rotating compass card. The range is determined by the map range. The range is 1/4 of the map range (e.g., 37.5 nm on a 150 nm map).

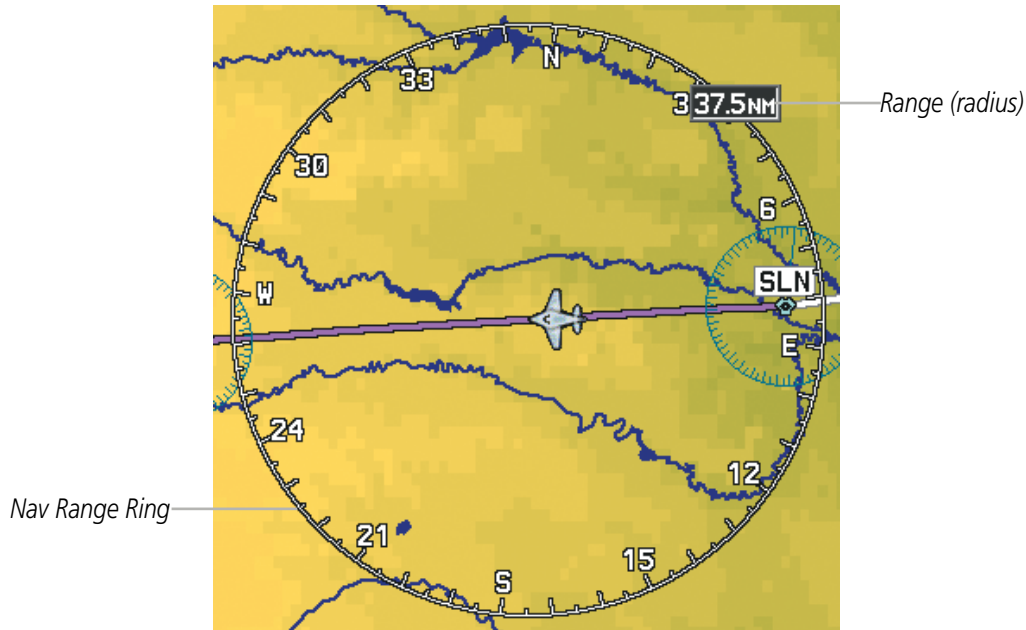

Figure 5-27 Navigation Map - Nav Range Ring



**NOTE:** The Nav Range Ring is not displayed on the Waypoint Information pages, Nearest pages, or Direct-to Window map.

### Displaying/removing the Nav Range Ring:

- 1) Press the **MENU** Key with the Navigation Map Page displayed. The cursor flashes on the 'Map Setup' option.
- 2) Press the **ENT** Key. The Map Setup Menu is displayed.
- 3) Select the 'Map' group.
- 4) Press the **ENT** Key.
- 5) Highlight the 'NAV RANGE RING' field.
- 6) Select 'On' or 'Off'.
- 7) Press the **FMS** Knob to return to the Navigation Map Page.



**NOTE:** The Nav Range Ring is referenced to either magnetic or true north, based on the selection on the AUX - System Setup Page.

## FUEL RANGE RING

The map can display a fuel range ring which shows the remaining flight distance. A dashed green circle indicates the selected range to reserve fuel. A solid green circle indicates the total endurance range. If only reserve fuel remains, the range is indicated by a solid yellow circle.

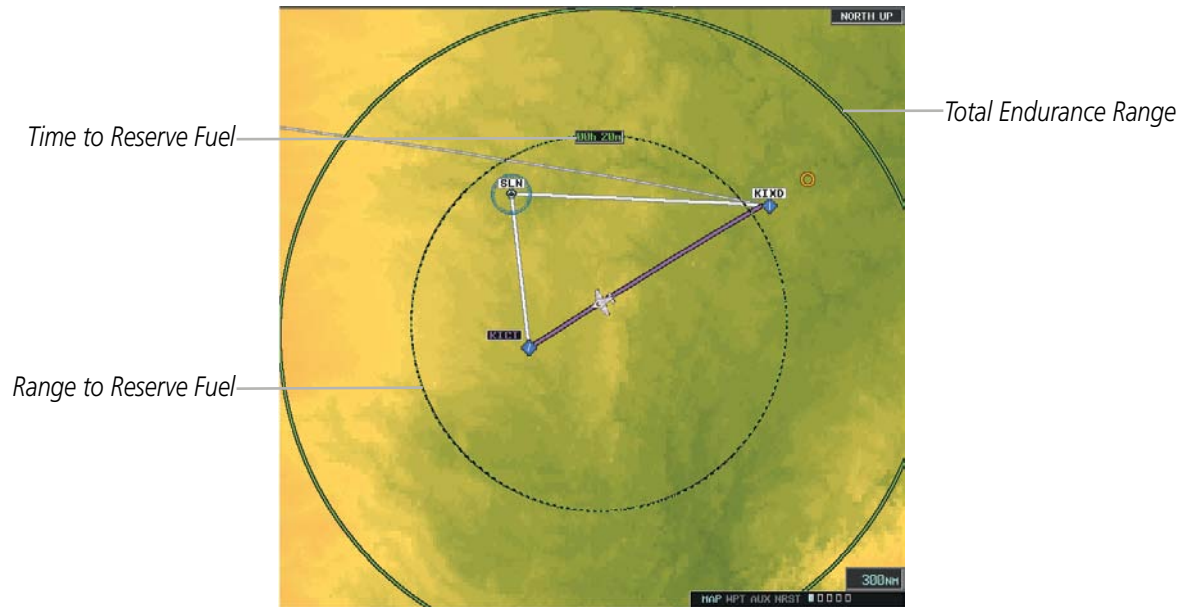

Figure 5-28 Navigation Map - Fuel Range Ring

### Displaying/removing the fuel range ring and selecting a fuel range time:

- 1) Press the **MENU** Key with the Navigation Map Page displayed. The cursor flashes on the 'Map Setup' option.
- 2) Press the **ENT** Key. The Map Setup Menu is displayed.
- 3) Select the 'Map' group.
- 4) Press the **ENT** Key.
- 5) Highlight the 'FUEL RNG (RSV)' field.
- 6) Select 'On' or 'Off'.
- 7) Highlight the fuel reserve time field. This time should be set to the amount of flight time equal to the amount of fuel reserve desired.
- 8) To change the reserve fuel time, enter a time (00:00 to 23:59; hours:minutes). The default setting is 00:45 minutes.
- 9) Press the **ENT** Key.
- 10) Press the **FMS** Knob to return to the Navigation Map Page.

## FIELD OF VIEW (SVS)

The map can display the boundaries of the PFD Synthetic Vision System (SVS) lateral field of view. The field of view is shown as two dashed lines forming a V shape in front of the aircraft symbol on the map. This is only available if SVS is installed on the aircraft.

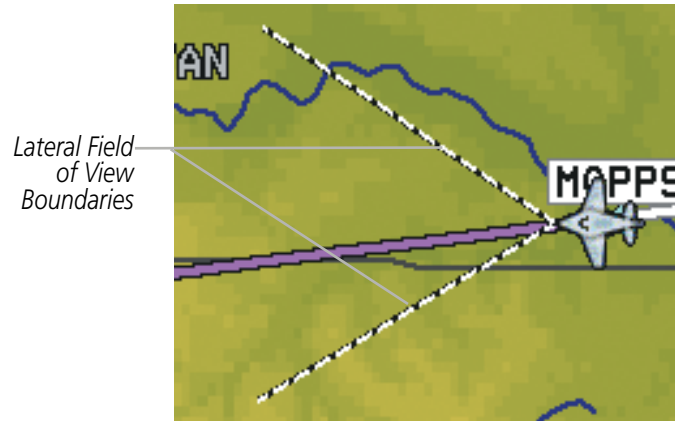

Figure 5-29 Navigation Map - Field of View

### Displaying/removing the field of view:

- 1) Press the **MENU** Key with the Navigation Map Page displayed. The cursor flashes on the 'Map Setup' option.
- 2) Press the **ENT** Key. The Map Setup Menu is displayed.
- 3) Select the 'Map' group.
- 4) Press the **ENT** Key.
- 5) Highlight the 'FIELD OF VIEW' field.
- 6) Select 'On' or 'Off'.
- 7) Press the **FMS** Knob to return to the Navigation Map Page.

## SELECTED ALTITUDE INTERCEPT ARC

The map can display the location along the current track where the aircraft will intercept the selected altitude. The location will be shown as a light blue arc when the aircraft is actually climbing or descending.

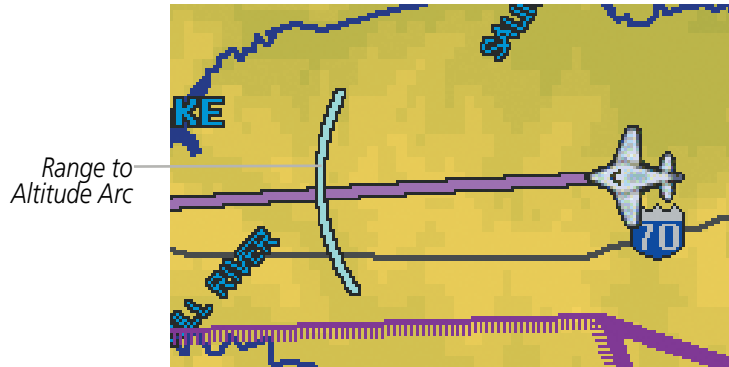

Figure 5-30 Navigation Map - Range to Altitude Arc

### Displaying/removing the selected altitude intercept arc:

- 1) Press the **MENU** Key with the Navigation Map Page displayed. The cursor flashes on the 'Map Setup' option.
- 2) Press the **ENT** Key. The Map Setup Menu is displayed.
- 3) Select the 'Map' group.
- 4) Press the **ENT** Key.
- 5) Highlight the 'SEL ALT ARC' field.
- 6) Select 'On' or 'Off'.
- 7) Press the FMS Knob to return to the Navigation Map Page.

### 5.3 WAYPOINTS

Waypoints are predetermined geographical positions (internal database) or pilot-entered positions, and are used for all phases of flight planning and navigation.

Communication and navigation frequencies can be tuned “automatically” from various Waypoint Information (WPT) pages, Nearest (NRST) pages, and the Nearest Airports Window (on PFD). This auto-tuning feature simplifies frequency entry over manual tuning. Refer to the Audio Panel and CNS section for details on auto-tuning.

Waypoints can be selected by entering the ICAO identifier, entering the name of the facility, or by entering the city name. See the System Overview section for detailed instructions on entering data in the G1000. As a waypoint identifier, facility name, or location is entered, the G1000’s Spell’N’Find™ feature scrolls through the database, displaying those waypoints matching the characters which have been entered to that point. A direct-to navigation leg to the selected waypoint can be initiated by pressing the **Direct-to** Key on any of the waypoint pages.



Figure 5-31 Waypoint Information Window

If duplicate entries exist for the entered facility name or location, additional entries may be viewed by continuing to turn the small **FMS** Knob during the selection process. If duplicate entries exist for an identifier, a Duplicate Waypoints Window is displayed when the **ENT** Key is pressed.



- SYSTEM OVERVIEW
- FLIGHT INSTRUMENTS
- EIS
- AUDIO PANEL & CNS
- FLIGHT MANAGEMENT
- HAZARD AVOIDANCE
- AFCS
- ADDITIONAL FEATURES
- APPENDICES
- INDEX



Figure 5-32 Waypoint Information Window - Duplicate Identifier

## AIRPORTS



**NOTE:** 'North Up' orientation on the Airport Information Page cannot be changed; the pilot needs to be aware of proper orientation if the Navigation Map orientation is different from the Airport Information Page Map.

The Airport Information Page is the first page in WPT group and allows the pilot to view airport information, load frequencies (COM, NAV, and lighting), review runways, and review instrument procedures that may be involved in the flight plan. See the Audio Panel and CNS Section for more information on loading frequencies (auto-tuning). After engine startup, the Airport Information Page defaults to the airport where the aircraft is located. After a flight plan has been loaded, it defaults to the destination airport. On a flight plan with multiple airports, it defaults to the airport which is the current active waypoint.

In addition to displaying a map of the currently selected airport and surrounding area, the Airport Information Page displays airport information in three boxes labeled 'AIRPORT', 'RUNWAYS', and 'FREQUENCIES'. For airports with multiple runways, information for each runway is available. This information is viewed on the Airport Information Page by pressing the INFO softkey until **INFO-1** is displayed.

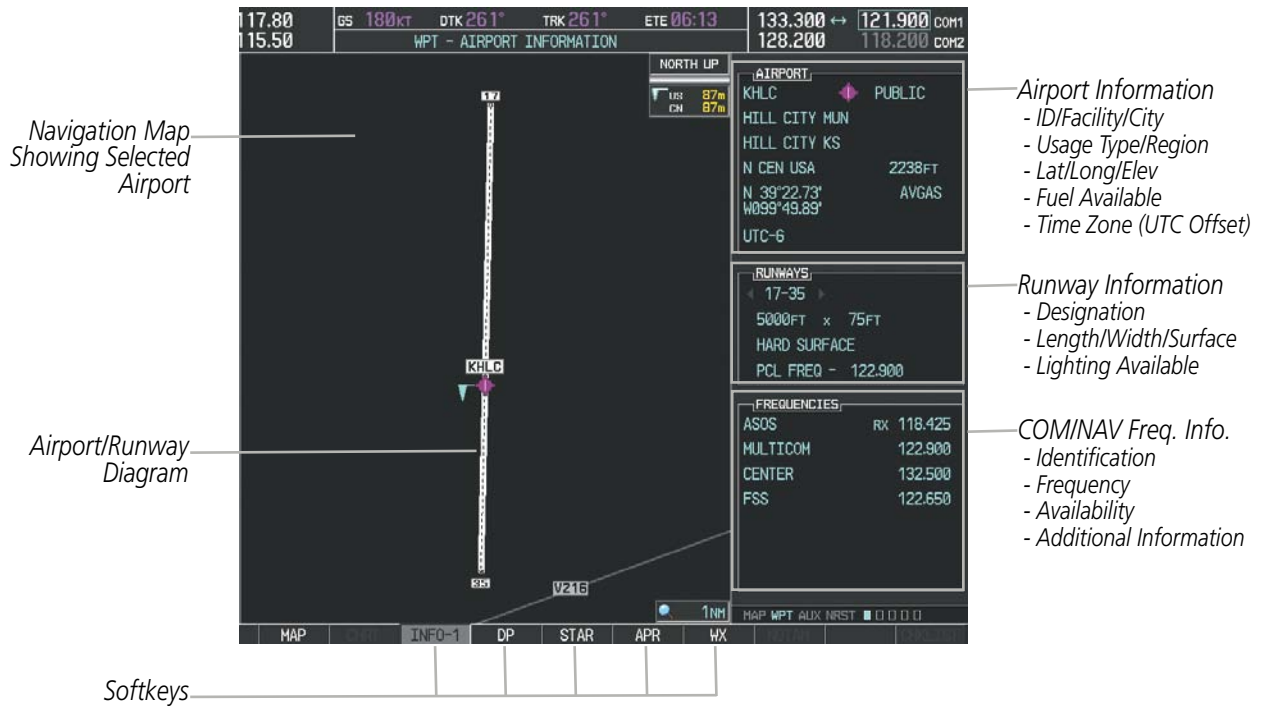

Figure 5-33 Airport Information Page

The following descriptions and abbreviations are used on the Airport Information Page:

- Usage type: Public, Military, Private, or Heliport
- Runway surface type: Hard, Turf, Sealed, Gravel, Dirt, Soft, Unknown, or Water
- Runway lighting type: No Lights, Part Time, Full Time, Unknown, or PCL Freq (for pilot-controlled lighting)
- COM Availability: TX (transmit only), RX (receive only), PT (part time), i (additional information available)

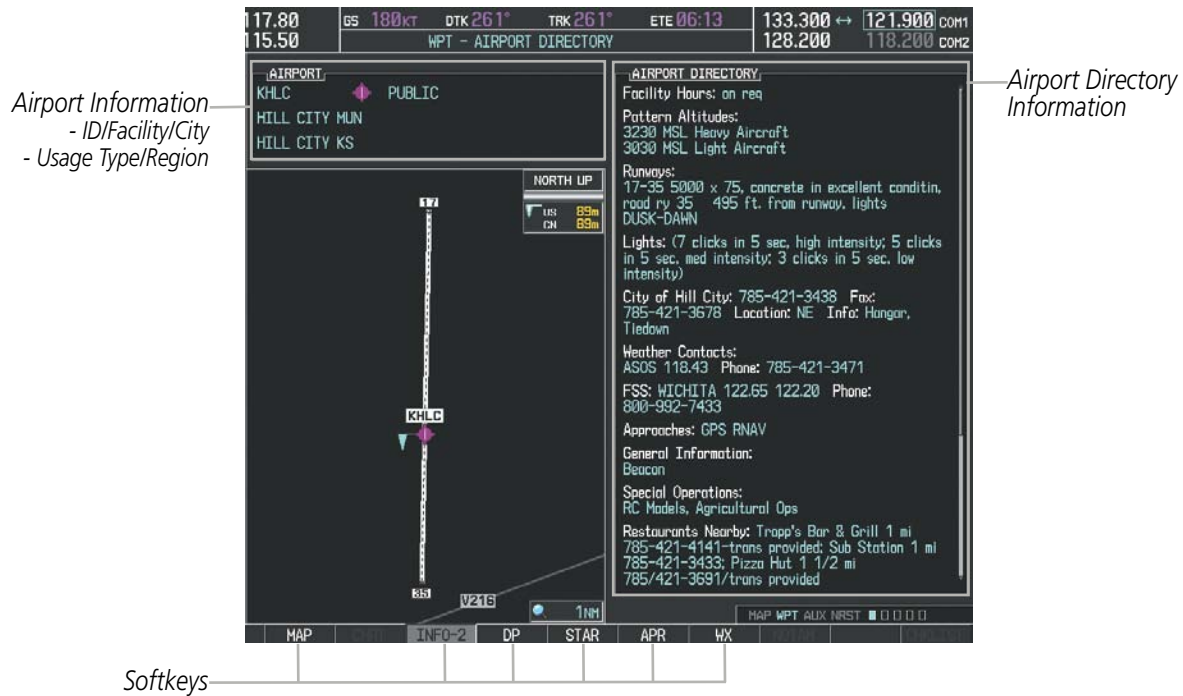

Figure 5-34 Airport Directory Page Example

The AOPA directory information is viewed on the Airport Directory Page by pressing the INFO softkey until **INFO-2** is displayed. The following are types of AOPA airport directory information shown (if available) on the Airport Directory Page:

- **Airport:** Identifier, Site Number, Name, City, State
- **Phones:** Phone/Fax Numbers
- **Hours:** Facility Hours, Light Hours, Tower Hours, Beacon Hours
- **Location:** Sectional, Magnetic Variation
- **Frequencies:** Type/Frequency
- **Transportation:** Ground Transportation Type Available
- **Approach:** Approach Facility Name, Frequency, Frequency Parameter
- **Traffic Pattern Altitudes (TPA):** Aircraft Class/Altitude
- **Weather:** Service Type, Frequency, Phone Number
- **Flight Service Station (FSS):** FSS Name, Phone Numbers
- **Instrument Approaches:** Published Approach, Frequency
- **NAVAIDS:** Type, Identifier, Frequency, Radial, Distance
- **Noise:** Noise Abatement Procedures
- **Charts:** Low Altitude Chart Number
- **Runway:** Headings, Length, Width, Obstructions, Surface
- **Obstructions:** General Airport Obstructions
- **Special Operations at Airport**
- **Services Available:** Category, Specific Service
- **Notes:** Airport Notes
- **Pilot Controlled Lighting:** High/Med/Low Clicks/Second
- **FBO:** Type, Frequencies, Services, Fees, Fuel, Credit Cards, Phone/Fax Numbers

**Selecting an airport for review by identifier, facility name, or location:**

- 1) From the Airport Information Page, press the **FMS** Knob.
- 2) Use the **FMS** Knobs and enter an identifier, facility name, or location.
- 3) Press the **ENT** Key.
- 4) Press the **FMS** Knob to remove the cursor.

**Selecting a runway:**

- 1) With the Airport Information Page displayed, press the **FMS** Knob to activate the cursor.
- 2) Turn the large **FMS** Knob to place the cursor in the 'RUNWAYS' Box, on the runway designator.
- 3) Turn the small **FMS** Knob to display the desired runway (if more than one) for the selected airport.
- 4) To remove the flashing cursor, press the **FMS** Knob.

**Viewing a destination airport:**

From the Airport Information Page press the **MENU** Key. Select 'View Destination Airport'. The Destination Airport is displayed.

The Airport Frequencies Box uses the descriptions and abbreviations listed in the following table:

Communication Frequencies			Navigation Frequencies
Approach *	Control	Pre-Taxi	ILS
Arrival *	CTA *	Radar	LOC
ASOS	Departure *	Ramp	
ATIS	Gate	Terminal *	
AWOS	Ground	TMA *	
Center	Helicopter	Tower	
Class B *	Multicom	TRSA *	
Class C *	Other	Unicom	
Clearance			
* May include Additional Information			

**Table 5-5 Airport Frequency Abbreviations**

A departure, arrival, or approach can be loaded using the softkeys on the Airport Information Page. See the Procedures section for details. METARs or TAFs applicable to the selected airport can be selected for display (see the Hazard Avoidance section for details about weather).

The G1000 provides a **NRST** Softkey on the PFD, which gives the pilot quick access to nearest airport information (very useful if an immediate landing is required). The Nearest Airports Window displays a list of up to the 25 nearest airports (three entries can be displayed at one time). If there are more than three they are displayed in a scrollable list. If there are no nearest airports available, "NONE WITHIN 200NM" is displayed.

SYSTEM OVERVIEW  
 FLIGHT INSTRUMENTS  
 EIS  
 AUDIO PANEL & CNS  
 FLIGHT MANAGEMENT  
 HAZARD AVOIDANCE  
 AFCS  
 ADDITIONAL FEATURES  
 APPENDICES  
 INDEX

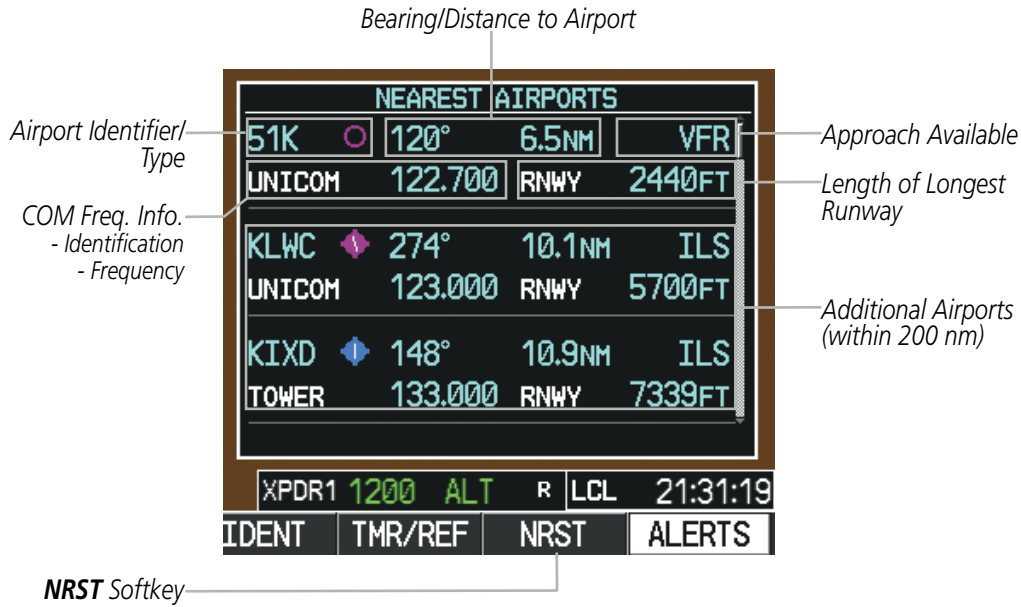

Figure 5-35 Nearest Airports Window on PFD

Pressing the **ENT** Key displays the PFD Airport Information Window for the highlighted airport. Pressing the **ENT** Key again returns to the Nearest Airports Window with the cursor on the next airport in the list. Continued presses of the **ENT** Key sequences through the information pages for all airports in the Nearest Airports list.



Figure 5-36 Airport Information Window on PFD

The Nearest Airports Page on the MFD is first in the group of NRST pages because of its potential use in the event of an in-flight emergency. In addition to displaying a map of the currently selected airport and surrounding area, the page displays nearest airport information in five boxes labeled 'NEAREST AIRPORTS', 'INFORMATION', 'RUNWAYS', 'FREQUENCIES', and 'APPROACHES'.

The selected airport is indicated by a white arrow, and a dashed white line is drawn on the navigation map from the aircraft position to the nearest airport. Up to five nearest airports, one runway, up to five frequencies, and up to five approaches are visible at one time. If there are more than can be shown, each list can be scrolled.

If there are no items for display in a boxed area, text indicating that fact is displayed. The currently selected airport remains in the list until it is unselected.



Figure 5-37 Nearest Airport Page

**Viewing information for a nearest airport on the PFD:**

- 1) Press the **NRST** Softkey to display the Nearest Airports Window. Press the **FMS** Knob to activate the cursor.
- 2) Highlight the airport identifier with the **FMS** Knob and press the **ENT** Key to display the Airport Information Window.
- 3) To return to the Nearest Airports Window press the **ENT** Key (with the cursor on 'BACK') or press the **CLR** Key. The cursor is now on the next airport in the nearest airports list. (Repeatedly pressing the **ENT** Key moves through the airport list, alternating between the Nearest Airports Window and the Airport Information Window.)
- 4) Press the **CLR** Key or the **NRST** Softkey to close the PFD Nearest Airports Window.

**Viewing information for a nearest airport on the MFD:**

- 1) Turn the large **FMS** Knob to select the NRST page group.
- 2) Turn the small **FMS** Knob to select the Nearest Airports Page (it is the first page of the group, so it may already be selected). If there are no Nearest Airports available, "NONE WITHIN 200 NM" is displayed.
- 3) Press the **APT** Softkey; or press the **FMS** Knob; or press the **MENU** Key, highlight 'Select Airport Window' and press the **ENT** Key. The cursor is placed in the 'NEAREST AIRPORTS' Box. The first airport in the nearest airports list is highlighted.
- 4) Turn the **FMS** Knob to highlight the desired airport. (Pressing the **ENT** Key also moves to the next airport.)
- 5) Press the **FMS** Knob to remove the flashing cursor.



**Viewing runway information for a specific airport:**

- 1) With the Nearest Airports Page displayed, press the **RNWX** Softkey; or press the **MENU** Key, highlight 'Select Runway Window'; and press the **ENT** Key. The cursor is placed in the 'RUNWAYS' Box.
- 2) Turn the small **FMS** Knob to select the desired runway.
- 3) Press the **FMS** Knob to remove the flashing cursor.

See the Audio Panel and CNS Section for frequency selection and the Procedures section for approaches.

The Nearest Airports Box on the System Setup Page defines the minimum runway length and surface type used when determining the 25 nearest airports to display on the MFD Nearest Airports Page. A minimum runway length and/or surface type can be entered to prevent airports with small runways or runways that are not appropriately surfaced from being displayed. Default settings are 0 feet (or meters) for runway length and "HARD/SOFT" for runway surface type.

**Selecting nearest airport surface matching criteria:**

- 1) Use the **FMS** Knob to select the System Setup Page.
- 2) Press the **FMS** Knob momentarily to activate the flashing cursor.
- 3) Turn the large **FMS** Knob to highlight the runway surface field in the Nearest Airports Box.
- 4) Turn the small **FMS** Knob to select the desired runway option (ANY, HARD ONLY, HARD/SOFT, WATER).
- 5) Press the **ENT** Key.
- 6) Press the **FMS** Knob to remove the flashing cursor.

**Selecting nearest airport minimum runway length matching criteria:**

- 1) Use the **FMS** Knob to select the System Setup Page.
- 2) Press the **FMS** Knob momentarily to activate the flashing cursor.
- 3) Turn the large **FMS** Knob to highlight the minimum length field in the Nearest Airport Box.
- 4) Use the **FMS** Knob to enter the minimum runway length (zero to 25,000 feet) and press the **ENT** Key.
- 5) Press the **FMS** Knob to remove the flashing cursor.



*Nearest Airport Criteria  
- Type of Runway Surface  
- Minimum Runway Length*

**Figure 5-38 System Setup Page - Nearest Airport Selection Criteria**

SYSTEM OVERVIEW

FLIGHT INSTRUMENTS

EIS

AUDIO PANEL & CNS

FLIGHT MANAGEMENT

HAZARD AVOIDANCE

AFCS

ADDITIONAL FEATURES

APPENDICES

INDEX



INTERSECTIONS

**NOTE:** The VOR displayed on the Intersection Information Page is the nearest VOR, not necessarily the VOR used to define the intersection.

The Intersection Information Page is used to view information about intersections. In addition to displaying a map of the currently selected intersection and surrounding area, the Intersection Information Page displays intersection information in three boxes labeled 'INTERSECTION', 'INFORMATION', and 'NEAREST VOR'.



Figure 5-39 Intersection Information Page

Selecting an intersection:

- 1) With the Intersection Information Page displayed, enter an identifier in the Intersection Box.
- 2) Press the **ENT** Key.
- 3) Press the **FMS** Knob to remove the flashing cursor.

Or:

- 1) With the Nearest Intersections Page displayed, press the **FMS** Knob.
- 2) Press the **ENT** Key or turn either **FMS** Knob to select an identifier in the Nearest Intersection Box.
- 3) Press the **FMS** Knob to remove the flashing cursor.

The Nearest Intersections Page can be used to quickly find an intersection close to the flight path. In addition to displaying a map of the surrounding area, the page displays information for up to 25 nearest intersections in three boxes labeled 'NEAREST INT', 'INFORMATION', and 'REFERENCE VOR'.

SYSTEM OVERVIEW

FLIGHT INSTRUMENTS

EIS

AUDIO PANEL & CNS

FLIGHT MANAGEMENT

HAZARD AVOIDANCE

AFCS

ADDITIONAL FEATURES

APPENDICES

INDEX

The selected intersection is indicated by a white arrow. Up to eleven intersections are visible at a time. If there are more than can be shown, the list can be scrolled. If there are no items for display, text indicating that fact is displayed.



**NOTE:** The list only includes waypoints that are within 200 nm.



Figure 5-40 Nearest Intersections Page

NDBs

The NDB Information Page is used to view information about NDBs. In addition to displaying a map of the currently selected NDB and surrounding area, the page displays NDB information in four boxes labeled 'NDB', 'INFORMATION', 'FREQUENCY', and 'NEAREST AIRPORT'.



Figure 5-41 NDB Information Page



**NOTE:** Compass locator (LOM, LMM): a low power, low or medium frequency radio beacon installed in conjunction with the instrument landing system. When LOM is used, the locator is at the Outer Marker; when LMM is used, the locator is at the Middle Marker.

Selecting an NDB:

- 1) With the NDB Information Page displayed, enter an identifier, the name of the NDB, or the city in which it's located in the NDB Box.
  - 2) Press the **ENT** Key.
  - 3) Press the **FMS** Knob to remove the flashing cursor.
- Or:**
- 1) With the Nearest NDB Page displayed, press the **FMS** Knob.
  - 2) Press the **ENT** Key or turn either **FMS** Knob to select an identifier in the Nearest NDB Box.
  - 3) Press the **FMS** Knob to remove the flashing cursor.

The Nearest NDB Page can be used to quickly find a NDB close to the flight path. In addition to displaying a map of the surrounding area, the page displays information for up to 25 nearest NDBs in three boxes labeled 'NEAREST NDB', 'INFORMATION', and 'FREQUENCY'.

SYSTEM OVERVIEW

FLIGHT INSTRUMENTS

EIS

AUDIO PANEL & CNS

FLIGHT MANAGEMENT

HAZARD AVOIDANCE

AFCS

ADDITIONAL FEATURES

APPENDICES

INDEX

A white arrow before the NDB identifier indicates the selected NDB. Up to eleven NDBs are visible at a time. If there are more than can be shown, each list can be scrolled. The list only includes waypoints that are within 200nm. If there are no NDBs in the list, text indicating that there are no nearest NDBs is displayed. If there are no nearest NDBs in the list, the information and frequency fields are dashed.



Figure 5-42 Nearest NDB Page

VORs

The VOR Information Page can be used to view information about VOR and ILS signals (since ILS signals can be received on a NAV receiver), or to quickly auto-tune a VOR or ILS frequency. Localizer information cannot be viewed on the VOR Information Page. If a VOR station is combined with a TACAN station it is listed as a VORTAC on the VOR Information Page and if it includes only DME, it is displayed as VOR-DME.

In addition to displaying a map of the currently selected VOR and surrounding area, the VOR Information Page displays VOR information in four boxes labeled 'VOR', 'INFORMATION', 'FREQUENCY', and 'NEAREST AIRPORT'.



Figure 5-43 VOR Information Page

The VOR classes used in the VOR information box are: LOW ALTITUDE, HIGH ALTITUDE, and TERMINAL.

Selecting a VOR:

- 1) With the VOR Information Page displayed, enter an identifier, the name of the VOR, or the city in which it's located in the VOR Box.
- 2) Press the **ENT** Key.
- 3) Press the **FMS** Knob to remove the flashing cursor.

Or:

- 1) With the Nearest VOR Page displayed, press the **FMS** Knob or press the **VOR** Softkey.
- 2) Press the **ENT** Key or turn either **FMS** Knob to select an identifier in the Nearest VOR Box.
- 3) Press the **FMS** Knob to remove the flashing cursor.

Or:



- 1) With the Nearest VOR Page displayed, press the **MENU** Key.
- 2) Highlight 'Select VOR Window', and press the **ENT** Key.
- 3) Press the **ENT** Key or turn either **FMS** Knob to select an identifier in the Nearest VOR Box.
- 4) Press the **FMS** Knob to remove the flashing cursor.

The Nearest VOR Page can be used to quickly find a VOR station close to the aircraft. Also, a NAV frequency from a selected VOR station can be loaded from the Nearest VOR Page. In addition to displaying a map of the surrounding area, the Nearest VOR Page displays information for up to 25 nearest VOR stations in three boxes labeled 'NEAREST VOR', 'INFORMATION', and 'FREQUENCY'. The list only includes waypoints that are within 200 nm.

A white arrow before the VOR identifier indicates the selected VOR. Up to eleven VORs are visible at a time. If there are more than can be shown, each list can be scrolled. If there are no VORs in the list, text indicating that there are no nearest VORs is displayed. If there are no nearest VORs in the list, the information is dashed.



Figure 5-44 Nearest VOR Page

## USER WAYPOINTS

The G1000 can create and store up to 1,000 user-defined waypoints. User waypoints can be created from any map page (except PFD Inset Map, AUX-Trip Planning Page, or Procedure Pages) by selecting a position on the map using the **Joystick**, or from the User Waypoint Information Page by referencing a bearing/distance from an existing waypoint, bearings from two existing waypoints, or latitude and longitude. Once a waypoint has been created, it can be renamed, deleted, or moved. Temporary user waypoints are erased upon system power down.

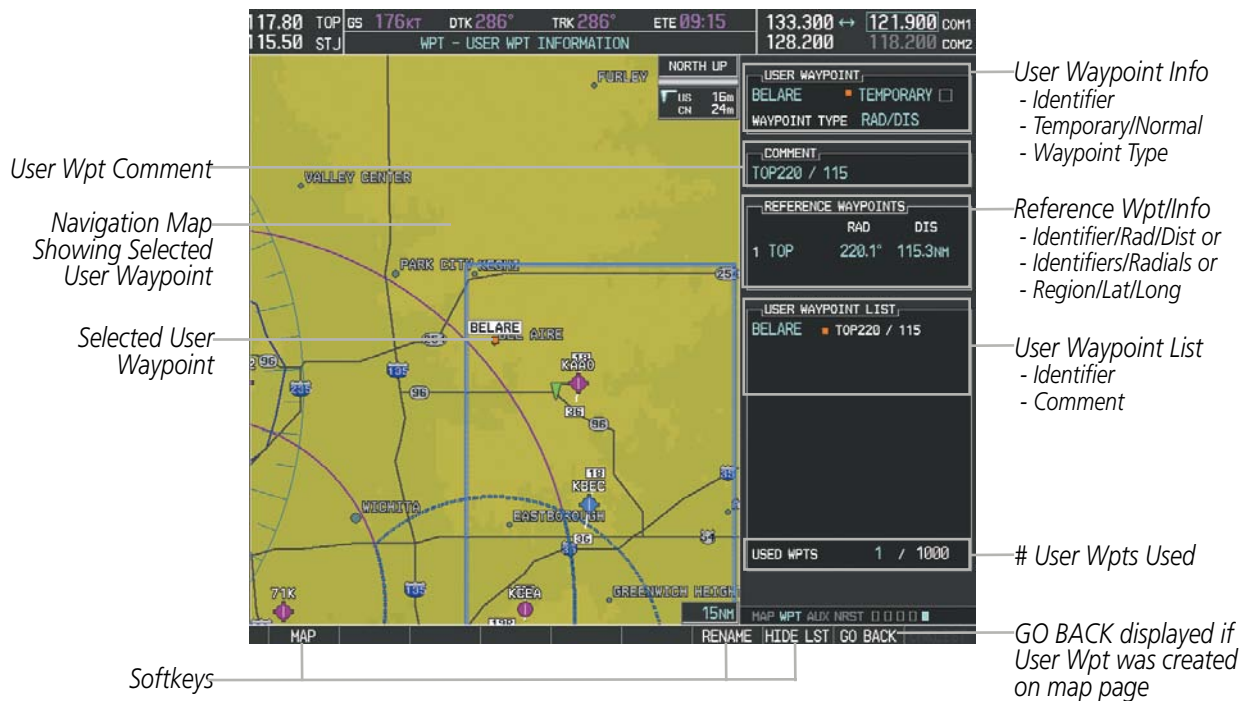

Figure 5-45 User Waypoint Information Page

### Selecting a User Waypoint:

- 1) With the User Waypoint Information Page displayed, enter the name of the User Waypoint, or scroll to the desired waypoint in the User Waypoint List using the large **FMS** Knob.
  - 2) Press the **ENT** Key.
  - 3) Press the **FMS** Knob to remove the flashing cursor.
- Or:**
- 1) With the Nearest User Waypoints Page displayed, press the **FMS** Knob.
  - 2) Press the **ENT** Key or turn either **FMS** Knob to select an identifier in the Nearest USR Box.
  - 3) Press the **FMS** Knob to remove the flashing cursor.



- SYSTEM OVERVIEW
- FLIGHT INSTRUMENTS
- EIS
- AUDIO PANEL & CNS
- FLIGHT MANAGEMENT
- HAZARD AVOIDANCE
- AFCS
- ADDITIONAL FEATURES
- APPENDICES
- INDEX



Figure 5-46 Nearest User Waypoint Page

## CREATING USER WAYPOINTS

User waypoints can be created from the User Waypoint Information Page in the following ways:

### Creating user waypoints from the User Waypoint Information Page:

- 1) Select the **NEW** Softkey, **or** press the **MENU** Key and select 'Create New User Waypoint'.
- 2) Enter a user waypoint name (up to six characters).
- 3) Press the **ENT** Key. The current aircraft position is the default location of the new waypoint.
- 4) If desired, define the type and location of the waypoint in one of the following ways:
  - a) Select "RAD/RAD" using the small **FMS** Knob, press the **ENT** Key, and enter the two reference waypoint identifiers and radials into the REFERENCE WAYPOINTS window using the **FMS** Knobs.  
**Or:**
    - b) Select "RAD/DIS" using the small **FMS** Knob, press the **ENT** Key, and enter the reference waypoint identifier, the radial, and the distance into the REFERENCE WAYPOINTS window using the **FMS** Knobs.  
**Or:**
      - c) Select "LAT/LON" using the small **FMS** Knob, press the **ENT** Key, and enter the latitude and longitude into the INFORMATION window using the **FMS** Knobs.
- 5) Press the **ENT** Key to accept the new waypoint.
- 6) If desired, change the storage method of the waypoint to "TEMPORARY" or "NORMAL" by moving the cursor to "TEMPORARY" and selecting the **ENT** Key to check or uncheck the box.
- 7) Press the **FMS** Knob to remove the flashing cursor.  
**Or:**

- 1) Press the **FMS** Knob to activate the cursor.
- 2) Enter a user waypoint name (up to six characters).
- 3) Press the **ENT** Key. The message 'Are you sure you want to create the new User Waypoint AAAAAA?' is displayed.
- 4) With 'YES' highlighted, press the **ENT** Key.
- 5) If desired, define the type and location of the waypoint in one of the following ways:
  - a) Select "RAD/RAD" using the small **FMS** Knob, press the **ENT** Key, and enter the two reference waypoint identifiers and radials into the REFERENCE WAYPOINTS window using the **FMS** Knobs.
  - Or:
  - b) Select "RAD/DIS" using the small **FMS** Knob, press the **ENT** Key, and enter the reference waypoint identifier, the radial, and the distance into the REFERENCE WAYPOINTS window using the **FMS** Knobs.
  - Or:
  - c) Select "LAT/LON" using the small **FMS** Knob, press the **ENT** Key, and enter the latitude and longitude into the INFORMATION window using the **FMS** Knobs.
- 6) Press the **ENT** Key to accept the new waypoint.
- 7) If desired, change the storage method of the waypoint to "TEMPORARY" or "NORMAL" by moving the cursor to "TEMPORARY" and selecting the **ENT** Key to check or uncheck the box.
- 8) Press the **FMS** Knob to remove the flashing cursor.

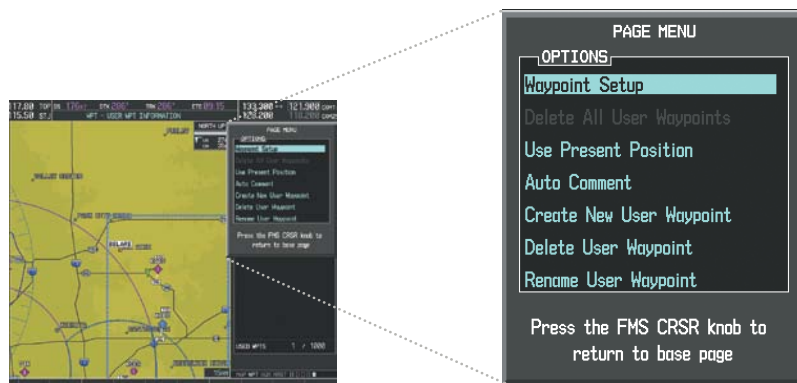

Figure 5-47 User Waypoint Information Page Menu

**Creating user waypoints from map pages:**

- 1) Press the **Joystick** to activate the panning function and pan to the map location of the desired user waypoint.
- 2) Press the **ENT** Key. The User Waypoint Information Page is displayed with the captured position.



**NOTE:** If the pointer has highlighted a map database feature, one of three things happens upon pressing the **ENT** Key: 1) information about the selected feature is displayed instead of initiating a new waypoint, 2) a menu pops up allowing a choice between 'Review Airspaces' or 'Create User Waypoint', or 3) a new waypoint is initiated with the default name being the selected map item.

- 3) Enter a user waypoint name (up to six characters).
- 4) Press the **ENT** Key to accept the selected name. The first reference waypoint box is highlighted.
- 5) If desired, define the type and location of the waypoint in one of the following ways:
  - a) Select "RAD/RAD" using the small **FMS** Knob, press the **ENT** Key, and enter the two reference waypoint identifiers and radials into the REFERENCE WAYPOINTS window using the **FMS** Knobs.  
**Or:**
  - b) Select "RAD/DIS" using the small **FMS** Knob, press the **ENT** Key, and enter the reference waypoint identifier, the radial, and the distance into the REFERENCE WAYPOINTS window using the **FMS** Knobs.  
**Or:**
  - c) Select "LAT/LON" using the small **FMS** Knob, press the **ENT** Key, and enter the latitude and longitude into the INFORMATION window using the **FMS** Knobs.
- 6) Press the **ENT** Key to accept the new waypoint.
- 7) If desired, change the storage method of the waypoint to "TEMPORARY" or "NORMAL" by moving the cursor to "TEMPORARY" and selecting the **ENT** Key to check or uncheck the box.
- 8) Press the **FMS** Knob to remove the flashing cursor.
- 9) Press the **GO BACK** Softkey to return to the map page.

## EDITING USER WAYPOINTS

### Editing a user waypoint comment or location:

- 1) With the User Waypoint Information Page displayed, press the **FMS** Knob to activate the cursor.
- 2) Select a user waypoint in the User Waypoint List, if required, and press the **ENT** Key.
- 3) Move the cursor to the desired field.
- 4) Turn the small **FMS** Knob to make any changes.
- 5) Press the **ENT** Key to accept the changes.
- 6) Press the **FMS** Knob to remove the flashing cursor.

### Renaming user waypoints:

- 1) Highlight a user waypoint in the User Waypoint List. Press the **RENAME** Softkey, or press the **MENU** Key and select 'Rename User Waypoint'.
- 2) Enter a new name.
- 3) Press the **ENT** Key. The message 'Do you want to rename the user waypoint AAAAAA toBBBBBB?' is displayed.
- 4) With 'YES' highlighted, press the **ENT** Key.
- 5) Press the **FMS** Knob to remove the flashing cursor.

**Changing the location of an existing waypoint to the aircraft present position:**

- 1) Enter a waypoint name or select the waypoint in the User Waypoint List, then press the **ENT** Key.
- 2) Press the **MENU** Key.
- 3) Select 'Use Present Position'.
- 4) Press the **ENT** Key twice. The new waypoint's location is saved.
- 5) Press the **FMS** Knob to remove the flashing cursor.

A system generated comment for a user waypoint incorporates the reference waypoint identifier, bearing, and distance. If a system generated comment has been edited, a new comment can be generated.

**Resetting the comment field to the system generated comment:**

- 1) Enter a waypoint name or select the waypoint in the User Waypoint List, then press the **ENT** Key.
- 2) Press the **MENU** Key.
- 3) Select 'Auto Comment'.
- 4) Press the **ENT** Key. The generated comment is based on the reference point used to define the waypoint.

The default type of user waypoint (normal or temporary) can be changed using the user waypoint information page menu. Temporary user waypoints are automatically deleted upon the next power cycle.

**Changing the user waypoint storage duration default setting:**

- 1) With the User Waypoint Information Page displayed, press the **MENU** Key.
- 2) Move the cursor to select 'Waypoint Setup', and press the **ENT** Key.
- 3) Select 'NORMAL' or 'TEMPORARY' as desired, and press the **ENT** Key.
- 4) Press the **FMS** Knob to remove the flashing cursor and return to the User Waypoint Information Page.

## DELETING USER WAYPOINTS

### Deleting a single user waypoint:

- 1) Highlight a User Waypoint in the User Waypoint List, or enter a waypoint in the User Waypoint field.
- 2) Press the **DELETE** Softkey or press the **CLR** Key. 'Yes' is highlighted in the confirmation window.
- 3) Press the **ENT** Key.
- 4) Press the **FMS** Knob to remove the flashing cursor.

#### Or:

- 1) Highlight a User Waypoint in the User Waypoint List, or enter a waypoint in the User Waypoint field.
- 2) Press the **MENU** Key.
- 3) Select 'Delete User Waypoint'.
- 4) Press the **ENT** Key twice to confirm the selection.
- 5) Press the **FMS** Knob to remove the flashing cursor.



**NOTE:** The option to 'Delete All User Waypoints' is not available while the aircraft is in flight.

### Deleting all user waypoints:

- 1) Highlight a User Waypoint in the User Waypoint List.
- 2) Press the **MENU** Key.
- 3) Select 'Delete All User Waypoints'.
- 4) Press the **ENT** Key twice to confirm the selection.
- 5) Press the **FMS** Knob to remove the flashing cursor.

## 5.4 AIRSPACES

The G1000 can display the following types of airspaces: Class B/TMA, Class C/TCA, Class D, Restricted, MOA (Military), Other Airspace, Air Defense Interdiction Zone (ADIZ), and Temporary Flight Restriction (TFR).



Figure 5-48 Airspaces

The Nearest Airspaces Page, Airspace Alerts Window, and Airspace Alerts on the PFD provide additional information about airspaces and the location of the aircraft in relationship to them.



The Airspace Alerts Box allows the pilot to turn the controlled/special-use airspace message alerts on or off. This does not affect the alerts listed on the Nearest Airspaces Page or the airspace boundaries depicted on the Navigation Map Page. It simply turns on/off the warning provided when the aircraft is approaching or near an airspace.

An altitude buffer is also provided which “expands” the vertical range above or below an airspace. For example, if the buffer is set at 500 feet, and the aircraft is more than 500 feet above/below an airspace, an alert message is not generated, but if the aircraft is less than 500 feet above/below an airspace and projected to enter it, the pilot is notified with an alert message. The default setting for the altitude buffer is 200 feet.

**Changing the altitude buffer distance setting:**

- 1) Use the **FMS** Knob to select the AUX - System Setup Page.
- 2) Press the **FMS** Knob momentarily to activate the flashing cursor.
- 3) Turn the large **FMS** Knob to highlight the altitude buffer field in the Airspace Alerts Box.
- 4) Use the **FMS** Knob to enter an altitude buffer value and press the **ENT** Key.
- 5) Press the **FMS** Knob to remove the flashing cursor.

**Turning an airspace alert on or off:**

- 1) Use the **FMS** Knob to select the AUX - System Setup Page.
- 2) Press the **FMS** Knob momentarily to activate the flashing cursor.
- 3) Turn the large **FMS** Knob to highlight the desired field in the Airspace Alerts Box.
- 4) Turn the small **FMS** Knob clockwise to turn the airspace alert ON or counterclockwise to turn the alert OFF.
- 5) Press the **FMS** Knob to remove the flashing cursor.



Airspace Alerts Box  
 - Airspace Altitude Buffer  
 - Alert On/Off  
 (Default Settings Shown)

DFLTS Softkey

Figure 5-49 System Setup Page - Airspace Alerts



Map ranges for the airspace boundaries are selected from the Aviation Group in the Map Setup Menu. See Table 5-2 for the default and maximum ranges for each type of airspace and the symbol used to define the airspace area.

The Nearest Airspaces Page can be used to quickly find airspaces close to the flight path. In addition, a selected frequency associated with the airspace can be loaded from the Nearest Airspaces Page. In addition to displaying a map of airspace boundaries and surrounding area, the Nearest Airspaces Page displays airspace information in four boxes labeled 'AIRSPACE ALERTS', 'AIRSPACE, AGENCY', 'VERTICAL LIMITS', and 'FREQUENCIES'.

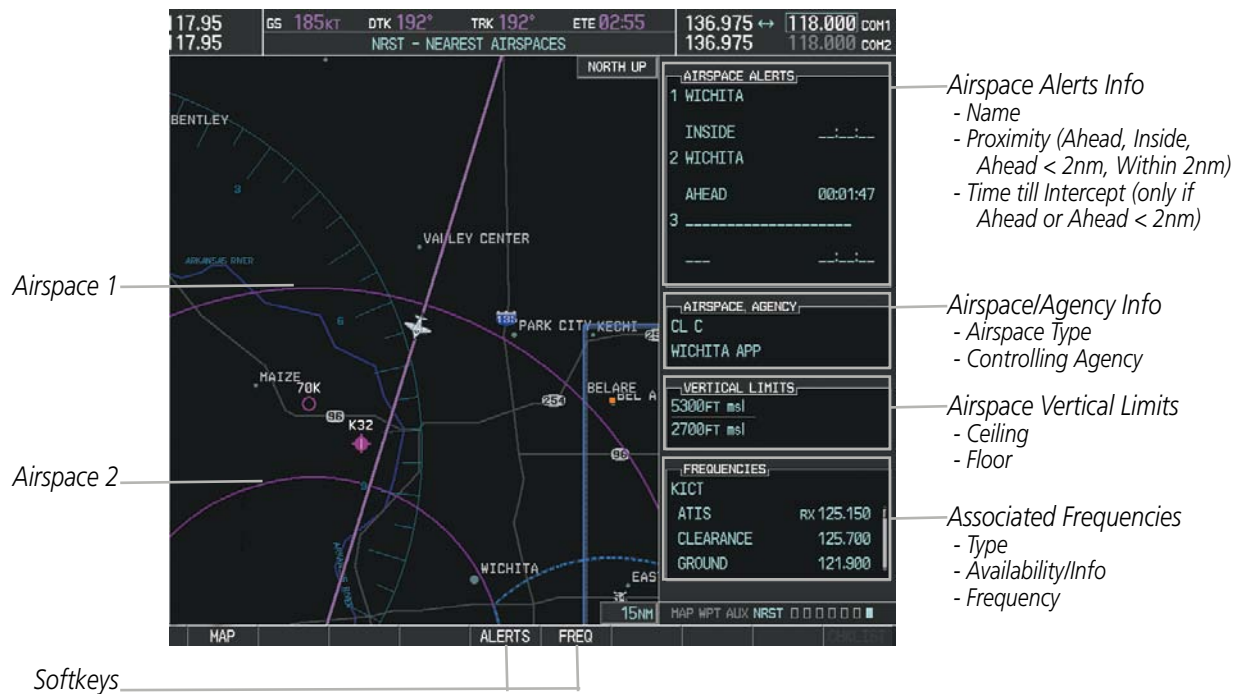

Figure 5-50 Nearest Airspaces Page

Airspace alerts and associated frequencies are shown in scrollable lists on the Nearest Airspaces Page. The **ALERTS** and **FREQ** softkeys place the cursor in the respective list. The **FREQ** Softkey is enabled only if one or more frequencies exist for a selected airspace.

**Selecting and viewing an airspace alert with its associated information:**

- 1) Select the Nearest Airspaces Page.
- 2) Press the **ALERTS** Softkey; or press the **FMS** Knob; or press the **MENU** Key, highlight 'Select Alerts Window', and press the **ENT** Key. The cursor is placed in the 'AIRSPACE ALERTS' Box.
- 3) Select the desired airspace.
- 4) Press the **FMS** Knob to remove the flashing cursor.

Pressing the PFD **ALERTS** Softkey displays the message window on the PFD. The following airspace alerts are displayed in the message window:

Message	Comments
<b>INSIDE ARSPC</b> – Inside airspace.	The aircraft is inside the airspace.
<b>ARSPC AHEAD</b> – Airspace ahead – less than 10 minutes.	Special use airspace is ahead of aircraft. The aircraft penetrates the airspace within 10 minutes.
<b>ARSPC NEAR</b> – Airspace near and ahead.	Special use airspace is near and ahead of the aircraft position.
<b>ARSPC NEAR</b> – Airspace near – less than 2 nm.	Special use airspace is within 2 nm of the aircraft position.

Table 5-6 PFD Airspace Alert Messages

SYSTEM OVERVIEW

FLIGHT INSTRUMENTS

EIS

AUDIO PANEL & CNS

FLIGHT MANAGEMENT

HAZARD AVOIDANCE

AFCS

ADDITIONAL FEATURES

APPENDICES

INDEX

## 5.5 DIRECT-TO-NAVIGATION

The Direct-to method of navigation, initiated by pressing the **Direct-to** Key on either the MFD or PFD, is quicker to use than a flight plan when the desire is to navigate to a single point such as a nearby airport.

Once a direct-to is activated, the G1000 establishes a point-to-point course line from the present position to the selected direct-to destination. Course guidance is provided until the direct-to is replaced with a new direct-to or flight plan, or cancelled.

A vertical navigation (VNV) direct-to creates a descent path (and provides guidance to stay on the path) from the current altitude to a selected altitude at the direct-to waypoint. Vertical navigation is based on barometric altitudes, not on GPS altitude, and is used for cruise and descent phases of flight.

The Direct-to Window allows selection and activation of direct-to navigation. The Direct-to Window displays selected direct-to waypoint data on the PFD and the MFD.

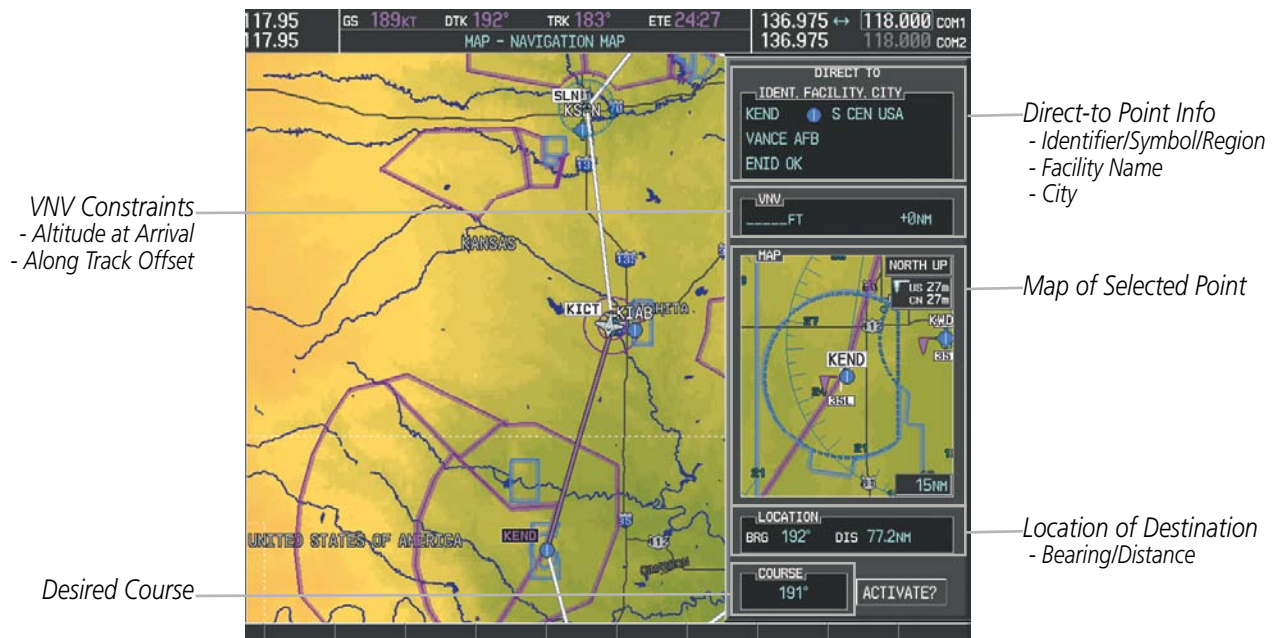

Figure 5-51 Direct-to Window - MFD

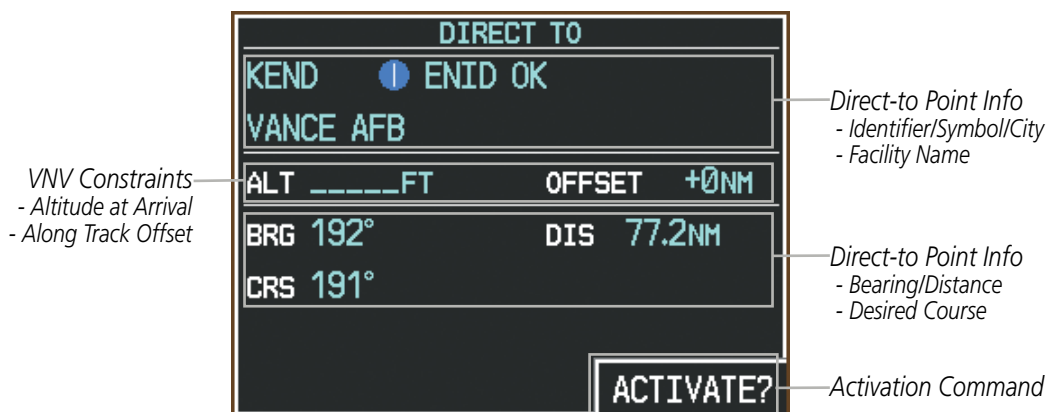

Figure 5-52 Direct-to Window - PFD

Any waypoint can be entered as a direct-to destination from the Direct-to Window.

**Entering a waypoint identifier, facility name, or city as a direct-to destination:**

- 1) Press the **Direct-to** Key. The Direct-to Window is displayed (with the active flight plan waypoint as the default selection or a blank waypoint field if no flight plan is active).
- 2) Turn the small **FMS** Knob clockwise to begin entering a waypoint identifier (turning it counter-clockwise brings up the waypoint selection submenu - press the **CLR** Key to remove it), or turn the large **FMS** Knob to select the facility name, or city field and turn the small **FMS** Knob to begin entering a facility name or city. If duplicate entries exist for the entered facility or city name, additional entries can be viewed by turning the small **FMS** Knob during the selection process.
- 3) Press the **ENT** Key. The 'Activate?' field is highlighted.
- 4) Press the **ENT** Key to activate the direct-to.

Any waypoint contained in the active flight plan can be selected as a direct-to waypoint from the Direct-to Window, the Active Flight Plan Page, or the Active Flight Plan Window.

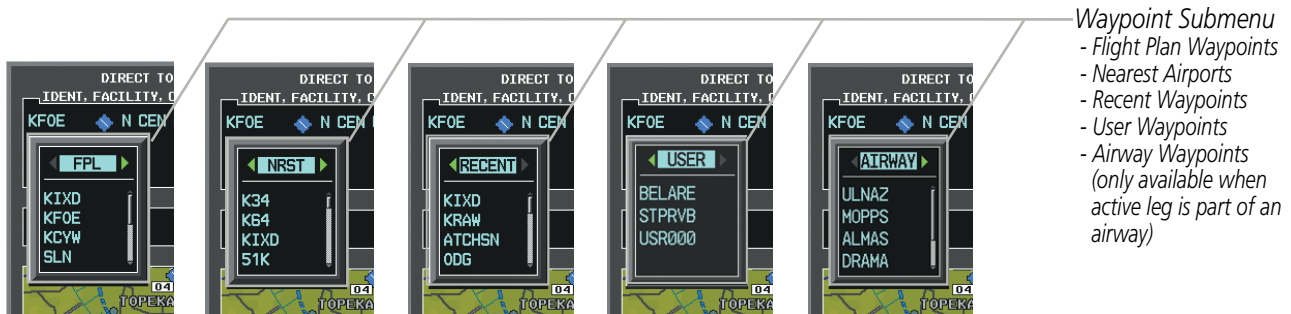

Figure 5-53 Waypoint Submenu

**Selecting an active flight plan waypoint as a direct-to destination:**

- 1) While navigating an active flight plan, press the **Direct-to** Key. The Direct-to Window is displayed with the active flight plan waypoint as the default selection.
- 2) Turn the small **FMS** Knob counter-clockwise to display a list of flight plan waypoints (the FPL list is populated only when navigating a flight plan).
- 3) Select the desired waypoint.
- 4) Press the **ENT** Key. The cursor is now displayed on 'ACTIVATE?'.
- 5) Press the **ENT** Key again to activate the direct-to.

**Or:**

- 1) Select the Active Flight Plan Page on the MFD, or the Active Flight Plan Window on the PFD.
- 2) Select the desired waypoint.
- 3) Press the **Direct-to** Key.
- 4) Press the **ENT** Key. The cursor is now displayed on 'ACTIVATE?'.
- 5) Press the **ENT** Key again to activate the direct-to.

Any NRST, RECENT, USER, or AIRWAY waypoints can be selected as a direct-to destination in the Direct-to Window.

#### Selecting a NRST, RECENT, USER, or AIRWAY waypoint as a direct-to destination:

- 1) Press the **Direct-to** Key. The Direct-to Window is displayed (with the active flight plan destination as the default selection or a blank destination if no flight plan is active).
- 2) Turn the small **FMS** Knob counter-clockwise to display a list of FPL waypoints (the FPL list is populated only when navigating a flight plan, and the AIRWAY list is available only when the active leg is part of an airway).
- 3) Turn the small **FMS** Knob clockwise to display the NRST, RECENT, USER, or AIRWAY waypoints.
- 4) Turn the large **FMS** Knob clockwise to select the desired waypoint.
- 5) Press the **ENT** Key. The cursor is now displayed on 'ACTIVATE?'.
- 6) Press the **ENT** Key again to activate the direct-to.

The Direct-to Window can be displayed from any page and allows selection and activation of direct-to navigation. If the direct-to is initiated from any page except the WPT pages, the default waypoint is the active flight plan waypoint (if a flight plan is active) or a blank waypoint field. Direct-to requests on any WPT page defaults to the displayed waypoint.

#### Selecting any waypoint as a direct-to destination:

- 1) Select the page or window containing the desired waypoint type and select the desired waypoint.
- 2) Press the **Direct-to** Key to display the Direct-to Window with the selected waypoint as the direct-to destination.
- 3) Press the **ENT** Key. The cursor is now displayed on 'ACTIVATE?'.
- 4) Press **ENT** again to activate the direct-to.

#### Selecting a nearby airport as a direct-to destination:

- 1) Select the **NRST** Softkey on the PFD; or turn the **FMS** Knob to display the Nearest Airports Page and press the **FMS** Knob.
- 2) Select the desired airport (the nearest one is already selected).
- 3) Press the **Direct-to** Key.
- 4) Press the **ENT** Key. The cursor is now displayed on 'ACTIVATE?'.
- 5) Press the **ENT** Key again to activate the direct-to.

Direct-to destinations may also be selected by using the pointer on the navigation map pages. If no airport, NAVAID, or user waypoint exists at the desired location, a temporary waypoint named 'MAPWPT' is automatically created at the location of the map arrow.

**Selecting a waypoint as a direct-to destination using the pointer:**

- 1) From a navigation map page, press the **Joystick** to display the pointer.
- 2) Move the **Joystick** to place the pointer at the desired destination location.
- 3) If the pointer is placed on an existing airport, NAVAID, or user waypoint, the waypoint name is highlighted.
- 4) Press the **Direct-to** Key to display the Direct-to Window with the selected point entered as the direct-to destination.
- 5) Press the **ENT** Key. The cursor is now displayed on 'ACTIVATE?'.
- 6) Press the **ENT** Key again to activate the direct-to.

**Cancelling a Direct-to:**

- 1) Press the **Direct-to** Key to display the Direct-to Window.
- 2) Press the **MENU** Key.
- 3) With 'Cancel Direct-To NAV' highlighted, press the **ENT** Key. If a flight plan is still active, the G1000 resumes navigating the flight plan along the closest leg.

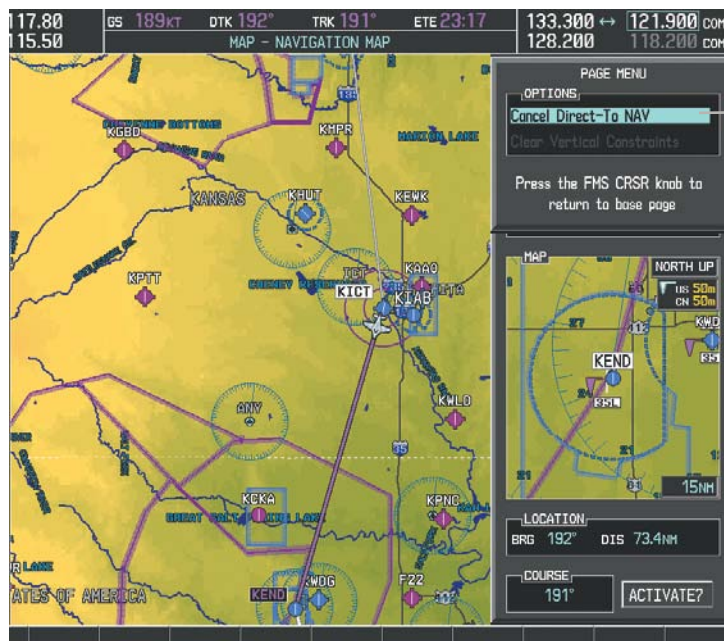

Figure 5-54 Direct-to Window - Cancelling Direct-to Navigation



When navigating a direct-to, the G1000 sets a direct great circle course to the selected destination. The course to a destination can also be manually selected using the course field ('COURSE') on the Direct-to Window.

#### Selecting a manual direct-to course:

- 1) Press the **Direct-to** Key. The Direct-to Window is displayed with the destination field highlighted.
- 2) Highlight the course field.
- 3) Enter the desired course.
- 4) Press the **ENT** Key. The cursor is now displayed on 'ACTIVATE?'.
- 5) Press the **ENT** Key again to activate the direct-to.

#### Reselecting the direct course from the current position:

- 1) Press the **Direct-to** Key. The Direct-to Window is displayed with the destination field highlighted.
- 2) Press the **ENT** Key. The cursor is now displayed on 'ACTIVATE?'.
- 3) Press the **ENT** Key again to activate the direct-to.

A direct-to with altitude constraints creates a descent path (and provides guidance to stay on the path) from the aircraft's current altitude to the altitude of the direct-to waypoint. The altitude is reached at the waypoint, or at the specified distance along the flight path if an offset distance has been entered. All VNV altitudes prior to the direct-to destination are removed from the active flight plan upon successful activation of a direct-to destination that is part of the active flight plan. All VNV altitudes following the direct-to waypoint are retained. See the section on Vertical Navigation for more information regarding the use and purpose of VNV altitudes and offset distances.

#### Entering a VNV altitude and along-track offset for the waypoint:

- 1) Press the **Direct-to** Key to display the Direct-to Window.
- 2) Turn the large **FMS** Knob to place the cursor over the 'VNV' altitude field.
- 3) Enter the desired altitude.
- 4) Press the **ENT** Key. The option to select MSL or AGL is now displayed.
- 5) Turn the small **FMS** Knob to select 'MSL' or 'AGL'.
- 6) Press the **ENT** Key. The cursor is now flashing in the VNV offset distance field.
- 7) Enter the desired along-track distance before the waypoint.
- 8) Press the **ENT** Key. The 'Activate?' field is highlighted.
- 9) Press the **ENT** Key to activate.



Removing a VNV altitude constraint:

- 1) Press the **Direct-to** Key to display the Direct-to Window.
- 2) Press the **MENU** Key.
- 3) With 'Clear Vertical Constraints' highlighted, press the **ENT** Key.







Page Menu  
- Clear Vertical Navigation Constraints

Figure 5-55 Direct-to Window - Clearing Vertical Constraints

## 5.6 FLIGHT PLANNING

Flight planning on the G1000 consists of building a flight plan by entering waypoints one at a time, adding waypoints along airways, and inserting departures, airways, arrivals, or approaches as needed. The G1000 allows flight planning information to be entered from either the MFD or PFD. The flight plan is displayed on maps using different line widths, colors, and types, based on the type of leg and the segment of the flight plan currently being flown (departure, enroute, arrival, approach, or missed approach).

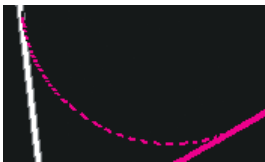
Flight Plan Leg Type	Symbol
Active non-heading Leg	
Active heading Leg	
Non-heading Leg in the current flight segment	
Heading Leg not in the current flight segment	
Non-heading Leg not in the active flight segment	
Turn Anticipation Arc	

**Table 5-7 Flight Plan Leg Symbols**

Up to 99 flight plans with up to 99 waypoints each can be created and stored in memory. One flight plan can be activated at a time and becomes the active flight plan. The active flight plan is erased when the system is turned off and overwritten when another flight plan is activated. When storing flight plans with an approach, departure, or arrival, the G1000 uses the waypoint information from the current database to define the waypoints. If the database is changed or updated, the G1000 automatically updates the information if the procedure has not been modified. If an approach, departure, or arrival procedure is no longer available, the procedure is deleted from the affected stored flight plan(s), and an alert is displayed (see Miscellaneous Messages in Appendix A) advising that one or more stored flight plans need to be edited.

Whenever an approach, departure, or arrival procedure is loaded into the active flight plan, a set of approach, departure, or arrival waypoints is inserted into the flight plan along with a header line describing the instrument procedure the pilot selected. The original enroute portion of the flight plan remains active (unless an instrument procedure is activated) when the procedure is loaded.

When the database is updated, the airways need to be reloaded also. Each airway segment is reloaded from the database given the entry waypoint, the airway identifier and the exit waypoint. This reloads the sequence of waypoints between the entry and exit waypoints (the sequence may change when the database is updated). The update of an airway can fail during this process. If that happens, the airway waypoints are changed to regular (non-airway) flight plan waypoints, and an alert is displayed (see Miscellaneous Messages in Appendix A).

SYSTEM OVERVIEW

FLIGHT INSTRUMENTS

EIS

AUDIO PANEL & CNS

FLIGHT MANAGEMENT

HAZARD AVOIDANCE

AFCS

ADDITIONAL FEATURES

APPENDICES

INDEX

The following could cause the airway update to fail:

- Airway identifier, entry waypoint or exit waypoint not found in the new database.
- Airway entry/exit waypoint is not an acceptable waypoint for the airway – either the waypoint is no longer on the airway, or there is a new directional restriction that prevents it being used.
- Loading the new airway sequence would exceed the capacity of the flight plan.

### FLIGHT PLAN CREATION

There are three methods to create or modify a flight plan:

- Active Flight Plan Page on the MFD (create/modify the active flight plan)
- Active Flight Plan Window on the PFD (create/modify the active flight plan)
- Flight Plan Catalog Page on the MFD (create/modify a stored flight plan)



Figure 5-56 Active Flight Plan Page



Figure 5-57 Active Flight Plan Window on PFD

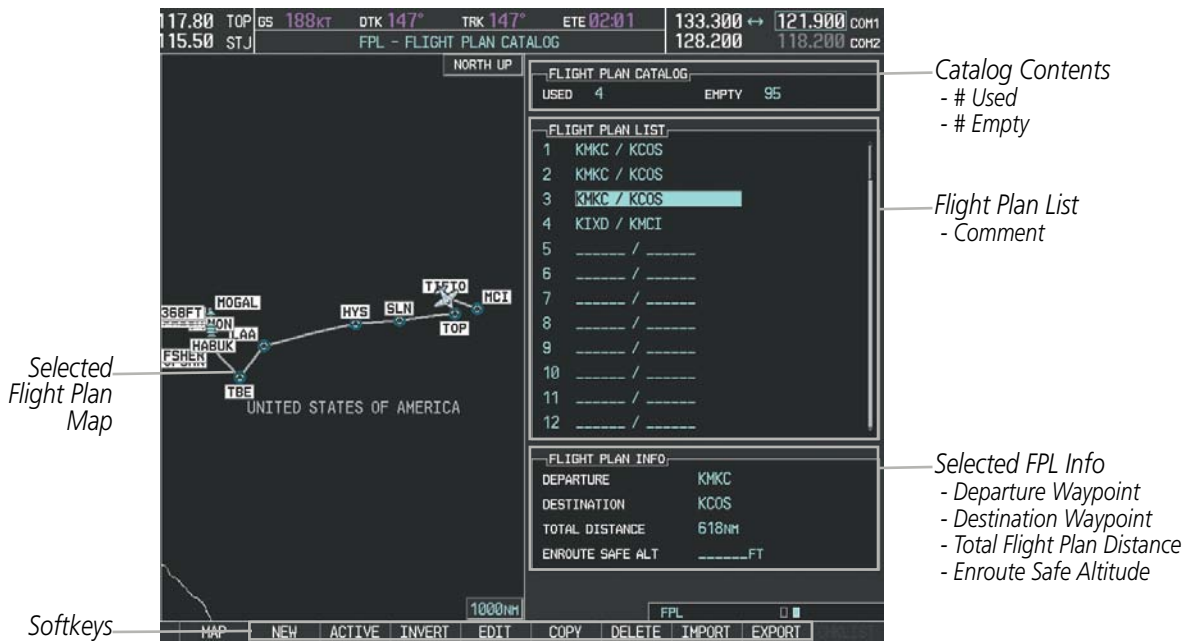

Figure 5-58 Flight Plan Catalog Page

The active flight plan is listed on the active Flight Plan Page on the MFD, and in the Active Flight Plan Window on the PFD. It is the flight plan to which the G1000 is currently providing guidance, and is shown on the navigation maps. Stored flight plans are listed on the Flight Plan Catalog Page, and are available for activation (becomes the active flight plan).

**Creating an active flight plan:**

- 1) Press the **FPL** Key.
- 2) Press the **FMS** Knob to activate the cursor (only on MFD).
- 3) Turn the small **FMS** Knob to display the Waypoint Information Window. (Turning it clockwise displays a blank Waypoint Information Window, turning it counter-clockwise displays the Waypoint Information Window with a waypoint selection submenu allowing selection of active flight plan, nearest, recent, user, or airway waypoints).

- 4) Enter the identifier, facility, or city name of the departure waypoint or select a waypoint from the submenu of waypoints and press the **ENT** Key. The active flight plan is modified as each waypoint is entered.
- 5) Repeat step numbers 3 and 4 to enter each additional flight plan waypoint.
- 6) When all waypoints have been entered, press the **FMS** Knob to remove the cursor.

#### Creating a stored flight plan:

- 1) Press the **FPL** Key.
- 2) Turn the small **FMS** Knob clockwise to display the Flight Plan Catalog Page.
- 3) Select the **NEW** Softkey; or press the **MENU** Key, highlight 'Create New Flight Plan', and press the **ENT** Key to display a blank flight plan for the first empty storage location.
- 4) Turn the small **FMS** Knob to display the Waypoint Information Window. (Turning it clockwise displays a blank Waypoint Information Window, turning it counter-clockwise displays the Waypoint Information Window with a waypoint selection submenu allowing selection of active flight plan, nearest, recent, user, or airway waypoints).
- 5) Enter the identifier, facility, or city name of the departure waypoint or select a waypoint from the submenu of waypoints and press the **ENT** Key.
- 6) Repeat step numbers 4 and 5 to enter each additional flight plan waypoint.
- 7) When all waypoints have been entered, press the **FMS** Knob to return to the Flight Plan Catalog Page. The new flight plan is now in the list.

Flight plans can be imported from an SD Card or exported to an SD Card from the Stored Flight Plan Page.

**Importing a Flight Plan from an SD Card**

- 1) Insert the SD card containing the flight plan in the top card slot on the MFD.
- 2) Press the **FPL** Key to display the Active Flight Plan Page on the MFD.
- 3) Turn the small **FMS** Knob to select the Flight Plan Catalog Page.
- 4) Press the **FMS** Knob to activate the cursor.
- 5) Turn either **FMS** Knob to highlight an empty or existing flight plan.
- 6) Press the **IMPORT** Softkey; or press the **MENU** Key, select "Import Flight Plan", and press the **ENT** Key.

If an empty slot is selected, a list of the available flight plans on the SD card will be displayed.

**Or:**

If an existing flight plan is selected, an "Overwrite existing flight plan? OK or CANCEL" prompt is displayed. Press the **ENT** Key to choose to overwrite the selected flight plan and see the list of available flight plans on the SD card. If overwriting the existing flight plan is not desired, select "CANCEL" using the **FMS** Knob, press the **ENT** Key, select another flight plan slot, and press the **IMPORT** Softkey again.

- 7) Turn the small **FMS** Knob to highlight the desired flight plan for importing.
- 8) Press the **ENT** Key to initiate the import.
- 9) Press the **ENT** Key again to confirm the import.



**Import/Export Softkeys**

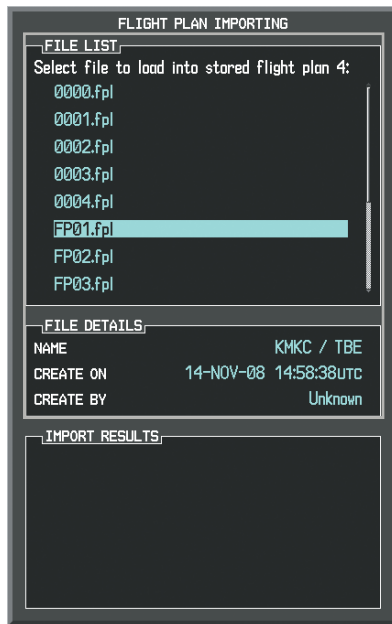

**List of Flight Plans to Import & Details for the Selected File**

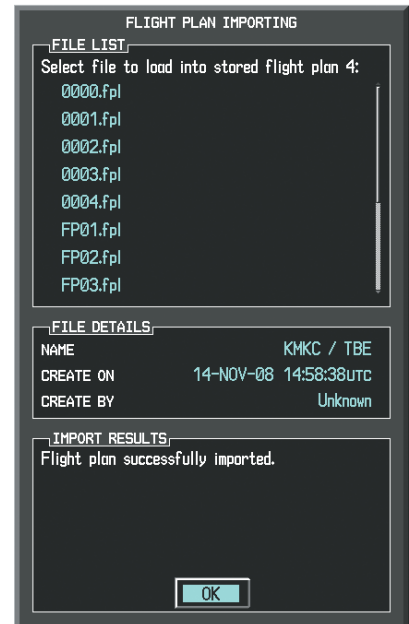

**Import Successful**

**Figure 5-59 Flight Plan Import**





**NOTE:** If the imported flight plan contains a waypoint with a name that duplicates the name of a waypoint already stored on the system, the system compares the coordinates of the imported waypoint with those of the existing waypoint. If the coordinates are different, the imported waypoint is automatically renamed by adding characters to the end of the name.

### Exporting a Flight Plan to an SD Card

- 1) Insert the SD card into the top card slot on the MFD.
- 2) Press the **FPL** Key to display the Active Flight Plan Page on the MFD.
- 3) Turn the small **FMS** Knob to select the Flight Plan Catalog Page.
- 4) Press the **FMS** Knob to activate the cursor.
- 5) Turn the large **FMS** Knob to highlight the flight plan to be exported.
- 6) Press the **EXPORT** Softkey; or press the **MENU** Key, select "Export Flight Plan".
- 7) If desired, change the name for the exported file by turning the large **FMS** Knob to the left to highlight the name, then use the small and large **FMS** knobs to enter the new name, and press the **ENT** Key.
- 8) Press the **ENT** Key to initiate the export.
- 9) Press the **ENT** Key to confirm the export.



**NOTE:** The exported flight plan will not contain any procedures or airways.

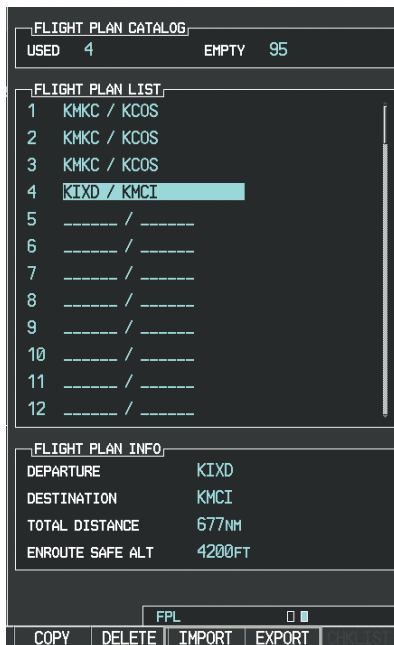

Import/Export Softkeys



Stored Flight Plan to be Exported & Exported Flight Plan Name



Export Successful

Figure 5-60 Flight Plan Export



## ADDING WAYPOINTS TO AN EXISTING FLIGHT PLAN

Waypoints can be added to the active flight plan or any stored flight plan. Choose the flight plan, select the desired point of insertion, enter the waypoint, and it is added in front of the selected waypoint. Flight plans are limited to 99 waypoints (including waypoints within airways and procedures). If the number of waypoints in the flight plan exceeds 99, the message “Flight plan is full. Remove unnecessary waypoints.” appears and the new waypoint(s) are not added to the flight plan.

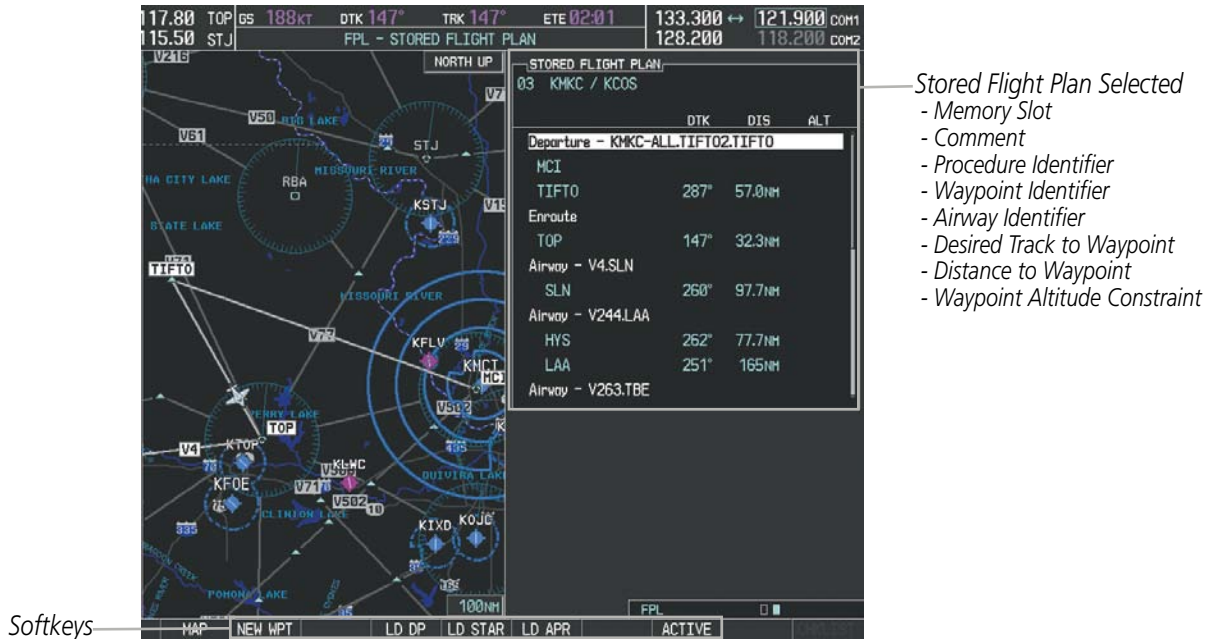

Figure 5-61 Stored Flight Plan Page

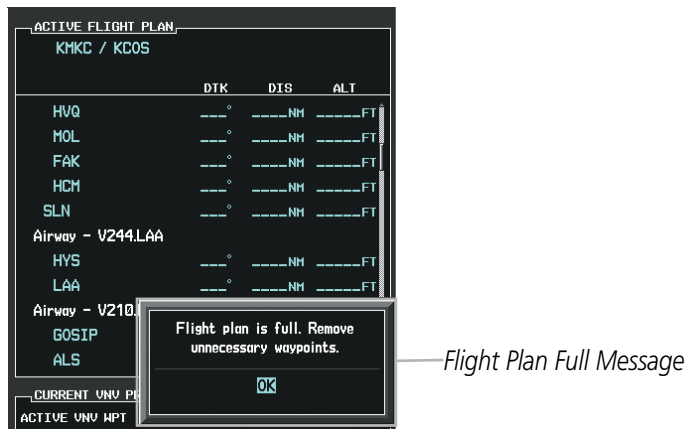

Figure 5-62 Active Flight Plan Page - FPL Full

### Adding a waypoint to a stored flight plan:

- 1) On the Flight Plan Catalog Page, press the **FMS** Knob to activate the cursor.
- 2) Highlight the desired flight plan.

- 3) Press the **EDIT** Softkey; or press the **ENT** Key, turn the large **FMS** Knob clockwise to select "EDIT" and press the **ENT** Key. The Stored Flight Plan Page is displayed.
- 4) Select the point in the flight plan to add the new waypoint. The new waypoint is placed directly in front of the highlighted waypoint.
- 5) Turn the small **FMS** Knob to display the Waypoint Information Window. (Turning it clockwise displays a blank Waypoint Information Window, turning it counter-clockwise displays the Waypoint Information Window with a waypoint selection submenu allowing selection of active flight plan, nearest, recent, user, or airway waypoints).
- 6) Enter the identifier, facility, or city name of the waypoint or select a waypoint from the submenu of waypoints and press the **ENT** Key. The new waypoint now exists in the flight plan.



**NOTE:** If the identifier entered in the Waypoint Information Window has duplicates, a Duplicate Waypoint Window is displayed. Use the FMS Knob to select the correct waypoint.

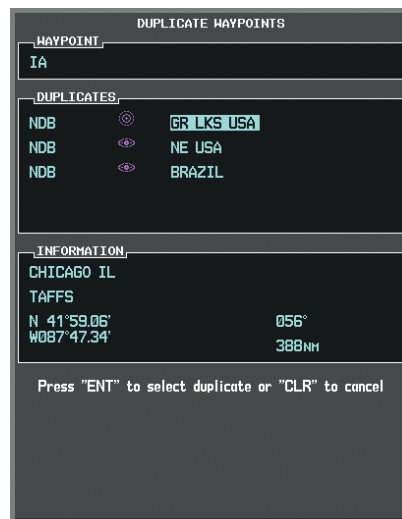

Figure 5-63 Duplicate Waypoints Window

**Adding a waypoint to the active flight plan:**

- 1) Press the **FPL** Key.
- 2) Press the **FMS** Knob to activate the cursor (not required on the PFD).
- 3) Select the point in the flight plan before which to add the new waypoint. The new waypoint is placed directly in front of the highlighted waypoint.
- 4) Turn the small **FMS** Knob to display the Waypoint Information Window. (Turning it clockwise displays a blank Waypoint Information Window, turning it counter-clockwise displays the Waypoint Information Window with a waypoint selection submenu allowing selection of active flight plan, nearest, recent, or airway waypoints).
- 5) Enter the identifier, facility, or city name of the waypoint or select a waypoint from the submenu of waypoints and press the **ENT** Key. The active flight plan is modified as each waypoint is entered.

- SYSTEM OVERVIEW
- FLIGHT INSTRUMENTS
- EIS
- AUDIO PANEL & CNS
- FLIGHT MANAGEMENT
- HAZARD AVOIDANCE
- AFCS
- ADDITIONAL FEATURES
- APPENDICES
- INDEX

**Creating and adding user waypoints to the active flight plan:**

- 1) Press the **Joystick** to activate the panning function on the Active Flight Plan Page and pan to the map location of the desired user waypoint.
- 2) Select the **LD WPT** Softkey; or press the **MENU** Key, select 'Load Waypoint', and press the **ENT** Key. The user waypoint is created with a name of USRxxx (using the next available in sequence) and is added to the end of the active flight plan.

**ADDING AIRWAYS TO A FLIGHT PLAN**

Airways can be added to the active flight plan or any stored flight plan. Choose a flight plan (add the desired airway entry point if not already in the flight plan), select the waypoint after the desired airway entry point, select the airway, and it is added in front of the selected waypoint. An airway can only be loaded if there is a waypoint in the flight plan that is part of the desired airway and is not part of an arrival or approach procedure. The G1000 also anticipates the desired airway and exit point based on loaded flight plan waypoints.



Figure 5-64 Select Airway Page - Selecting Airway

**Adding an airway to a flight plan:**

- 1) Press the **FPL** Key.
- 2) Press the **FMS** Knob to activate the cursor (not required on the PFD).
- 3) Turn the large **FMS** Knob to highlight the waypoint after the desired airway entry point. If this waypoint is not a valid airway entry point, a valid entry point should be entered at this time.
- 4) Turn the small **FMS** Knob one click clockwise and select the **LD AIRWY** Softkey, or press the **MENU** Key and select "Load Airway". The Select Airway Page is displayed. The **LD AIRWY** Softkey or the "Load Airway" menu item is available only when a valid airway entry waypoint has been chosen (the waypoint ahead of the cursor position).

- 5) Turn the **FMS** Knob to select the desired airway from the list, and press the **ENT** Key. Low altitude airways are shown first in the list, followed by "all" altitude airways, and then high altitude airways.
- 6) Turn the **FMS** Knob to select the desired airway exit point from the list, and press the **ENT** Key. 'LOAD?' is highlighted.
- 7) Press the **ENT** Key. The system returns to editing the flight plan with the new airway inserted.

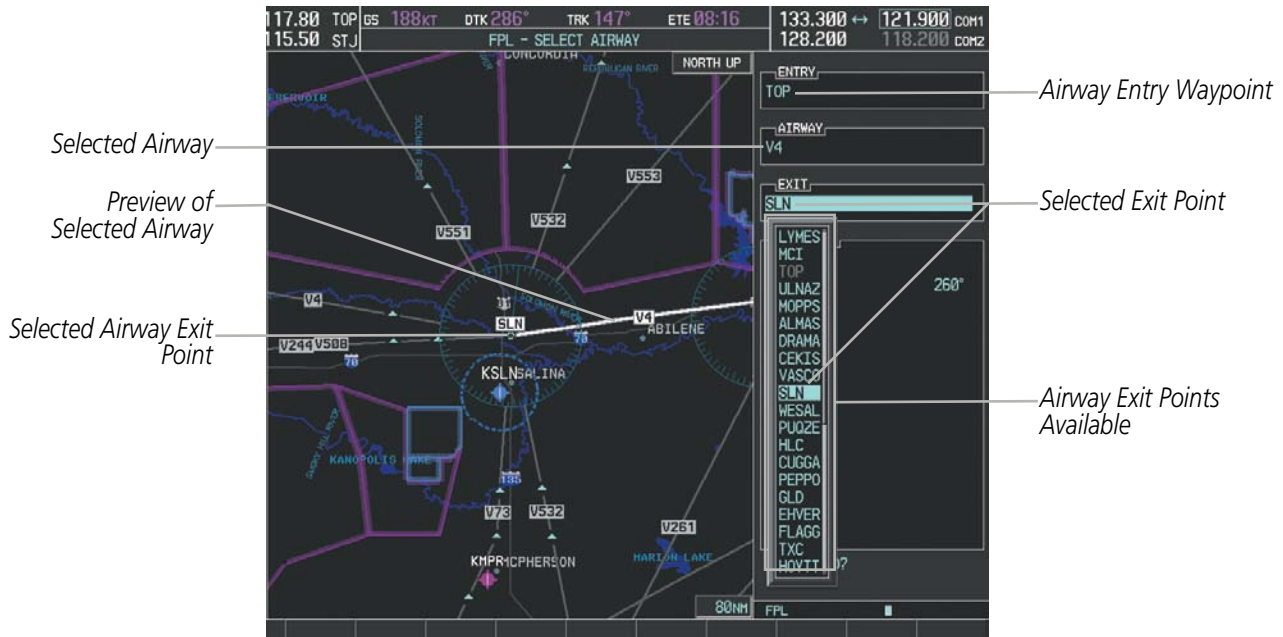

Figure 5-65 Select Airway Page - Selecting Exit Point

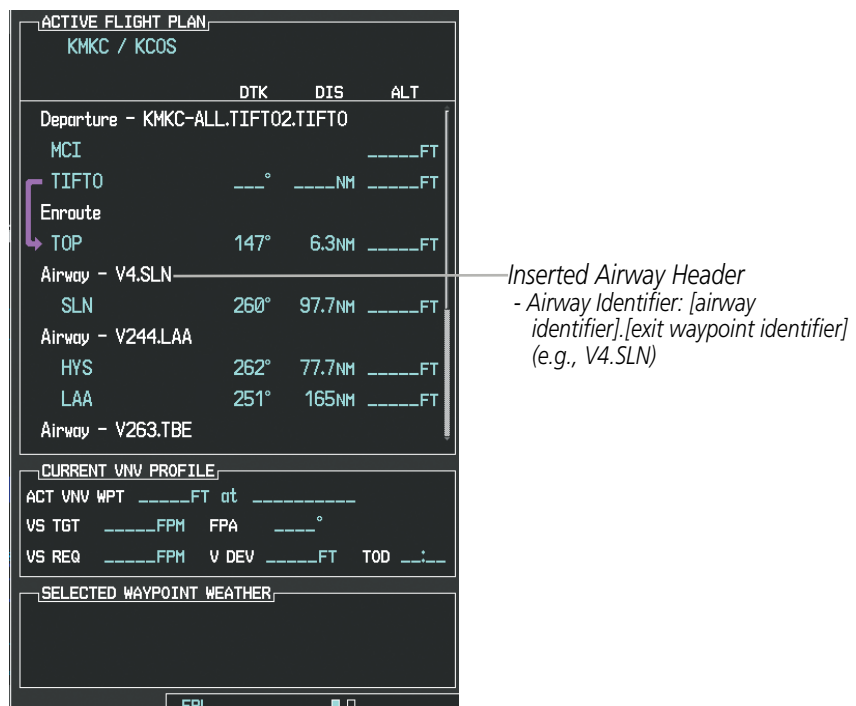

Figure 5-66 Active Flight Plan Page - Airway Inserted

## RESTRICTIONS ON ADDING AIRWAYS

Some airways have directional restrictions on all or part of the route. Airways “A2” in Europe has a directional restriction over the whole route such that it can be flown only in the direction MTD-ABB-BNE-DEVAL.

Airway “UR975” in North Africa has more complicated directional restrictions within the list of airway waypoints AMANO, VAKOR, LIBRO, NELDA, DIRKA, GZO, KOSET, and SARKI:

- Starting from AMANO, the airway can be flown only to LIBRO.
- Starting from SARKI, the airway can be flown only to LIBRO.
- Between NELDA and GZO, the airway can be flown in either direction.

In the US, airways that are “one-way” for specified hours of operation are not uncommon. These airways are always bidirectional in the G1000 database.

The system only allows correct airway sequences to be inserted. If the pilot subsequently inverts the flight plan, the system inverts the airway waypoint sequence and removes the airway header.

## ADDING PROCEDURES TO A STORED FLIGHT PLAN

The G1000 allows the pilot to insert pre-defined instrument procedures from the navigation database into a flight plan. The procedures are designed to facilitate routing of traffic leaving an airport (departure), arriving at an airport (arrival), and landing at an airport (approach). See the procedures section for more details.



Figure 5-67 Stored Flight Plan Page

DEPARTURE (DP)

A Departure Procedure (DP) is loaded at the departure airport in the flight plan. Only one departure can be loaded at a time in a flight plan. The route is defined by selection of a departure, the transition waypoints, and a runway.

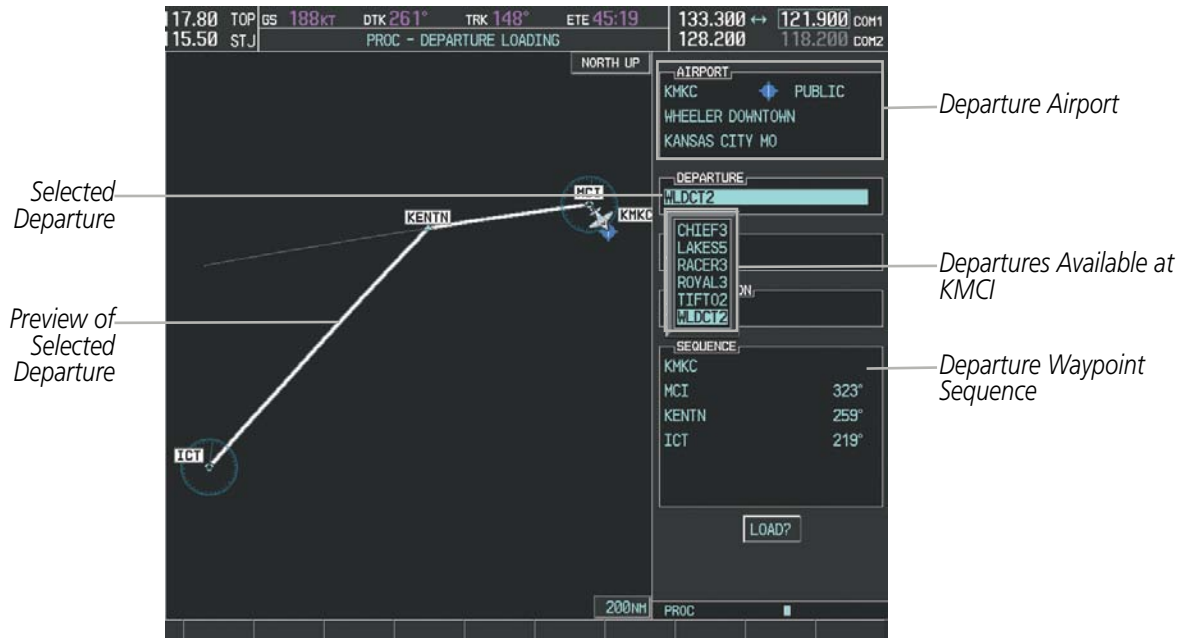

Figure 5-68 Departure Loading Page - Selecting the Departure

Loading a departure procedure into a stored flight plan:

- 1) Select a stored flight plan from the Flight Plan Catalog Page.
- 2) Select the **EDIT** Softkey; or press the **MENU** Key, select 'Edit Flight Plan', and press the **ENT** Key. The Stored Flight Plan Page is displayed.
- 3) Select the **LD DP** Softkey; or press the **MENU** Key, select "Load Departure", and press the **ENT** Key. The Departure Loading Page is displayed.
- 4) Select a departure. Press the **ENT** Key.
- 5) Select a runway served by the selected departure, if required. Press the **ENT** Key.
- 6) Select a transition for the selected departure. Press the **ENT** Key.
- 7) Press the **ENT** Key to load the selected departure procedure.



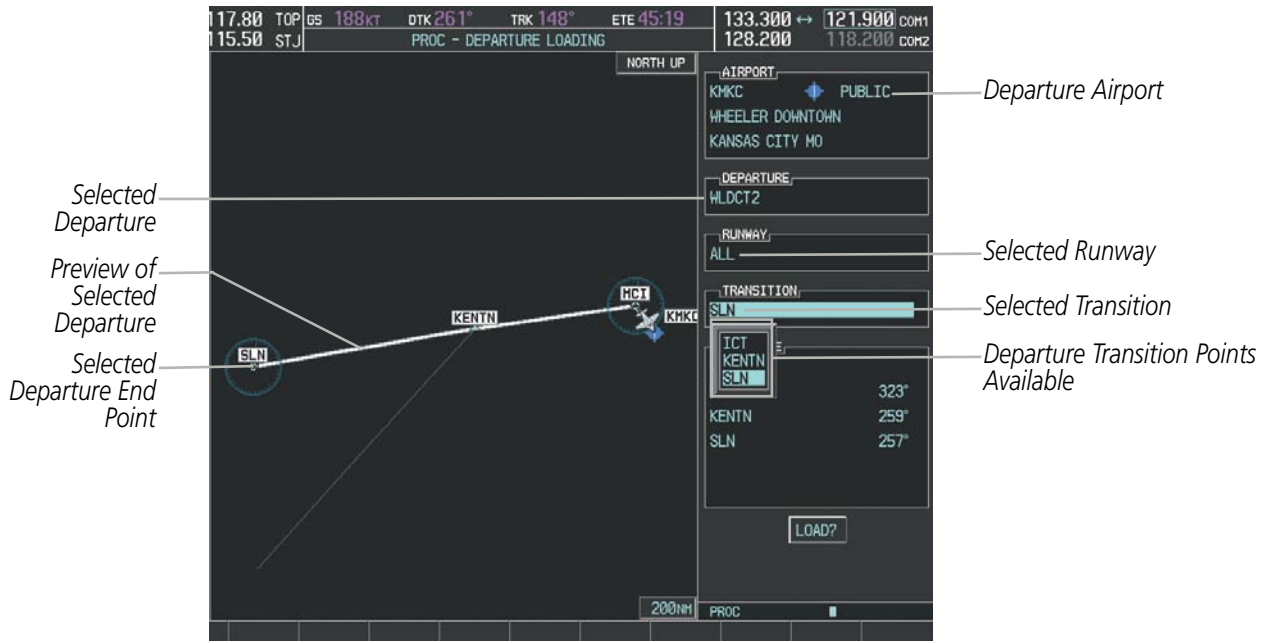

Figure 5-69 Departure Loading Page - Selecting Transition

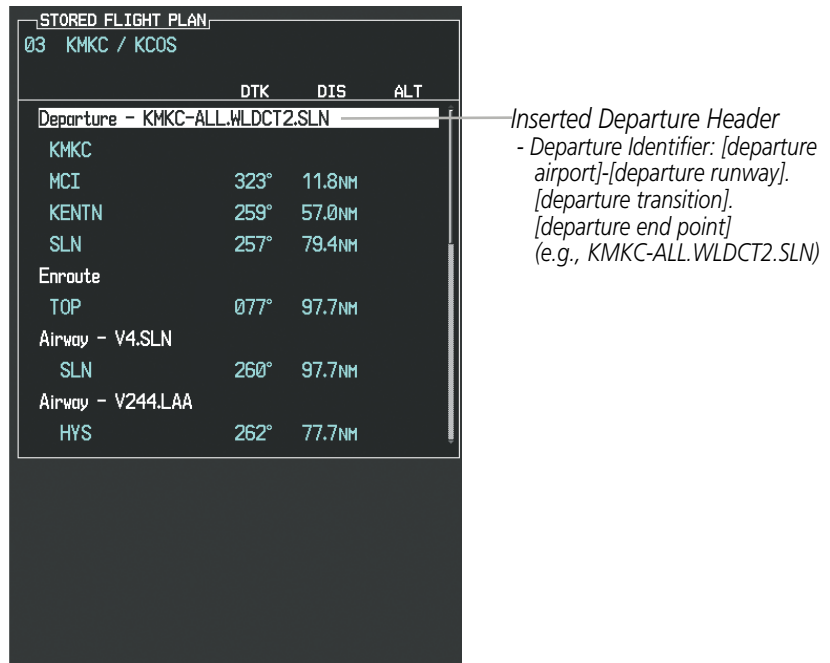

Figure 5-70 Stored Flight Plan Page - Departure Inserted



## ARRIVAL (STAR)

A Standard Terminal Arrival (STAR) is loaded at the destination airport in the flight plan. Only one arrival can be loaded at a time in a flight plan. The route is defined by selection of an arrival, the transition waypoints, and a runway.



Figure 5-71 Arrival Loading Page - Selecting the Arrival

### Loading an arrival procedure into a stored flight plan:

- 1) Select a stored flight plan from the Flight Plan Catalog Page.
- 2) Select the **EDIT** Softkey; or press the **MENU** Key, select 'Edit Flight Plan', and press the **ENT** Key. The Stored Flight Plan Page is displayed.
- 3) Select the **LD STAR** Softkey; or press the **MENU** Key, select "Load Arrival", and press the **ENT** Key. The Arrival Loading Page is displayed.
- 4) Select an arrival. Press the **ENT** Key.
- 5) Select a transition for the selected arrival. Press the **ENT** Key.
- 6) Select a runway served by the selected arrival, if required. Press the **ENT** Key.
- 7) Press the **ENT** Key to load the selected arrival procedure.



Figure 5-72 Arrival Loading Page - Selecting the Transition

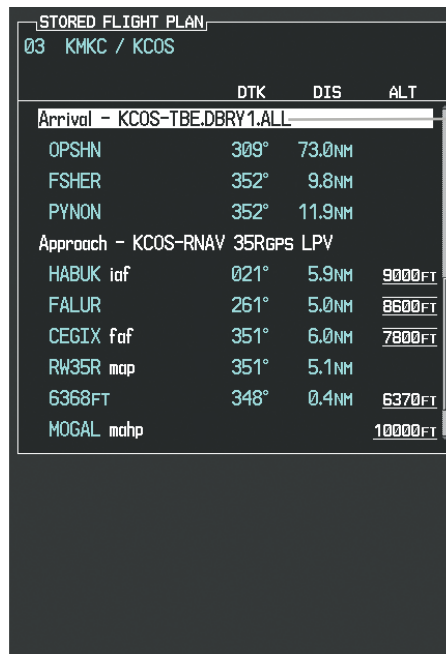

Inserted Arrival Header  
 - Arrival Identifier:  
 [arrival].[arrival runway]  
 (e.g., KCOS-TBE.DBRY1.ALL)

Figure 5-73 Stored Flight Plan Page - Arrival Inserted

## APPROACH (APPR)

An Approach Procedure (APPR) can be loaded at any airport that has an approach available. Only one approach can be loaded at a time in a flight plan. The route for a selected approach is defined by designating transition waypoints.

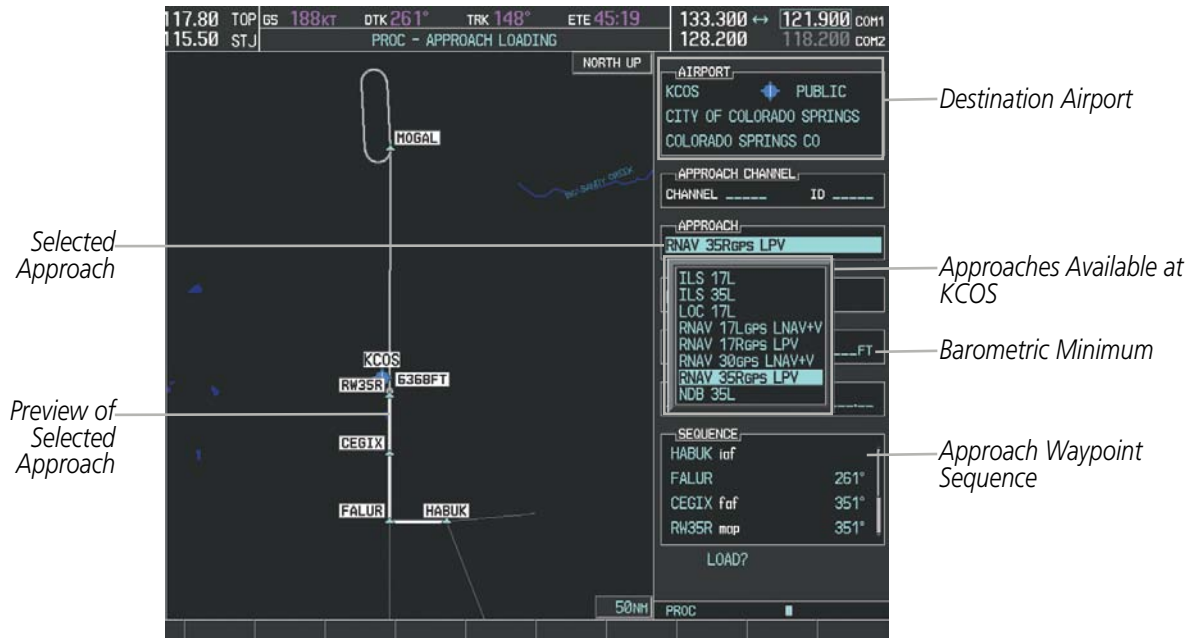

Figure 5-74 Approach Loading Page - Selecting the Approach

### Loading an approach procedure into a stored flight plan:

- 1) Select a stored flight plan from the Flight Plan Catalog Page.
- 2) Select the **EDIT** Softkey; or press the **MENU** Key, select 'Edit Flight Plan', and press the **ENT** Key. The Stored Flight Plan Page is displayed.
- 3) Select the **LD APR** Softkey; or press the **MENU** Key, select "Load Approach", and press the **ENT** Key. The Approach Loading Page is displayed.
- 4) Select an approach. Press the **ENT** Key.
- 5) Select a transition for the selected approach. Press the **ENT** Key.
- 6) Press the **ENT** Key to load the selected approach procedure.

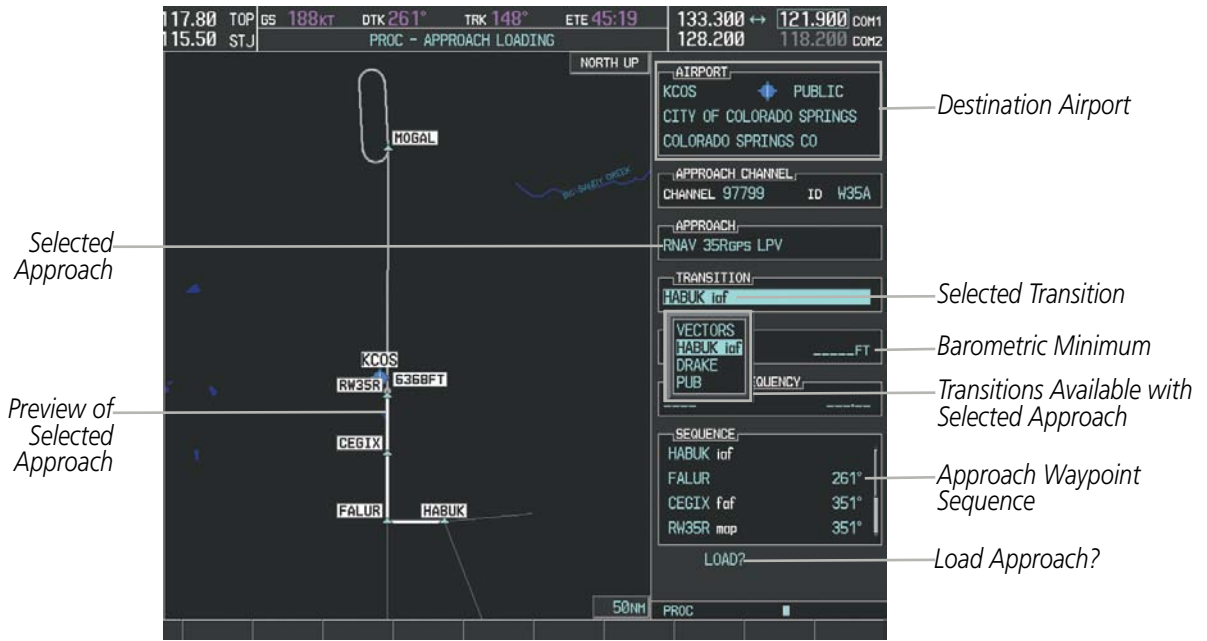

Figure 5-75 Approach Loading Page - Selecting the Transition

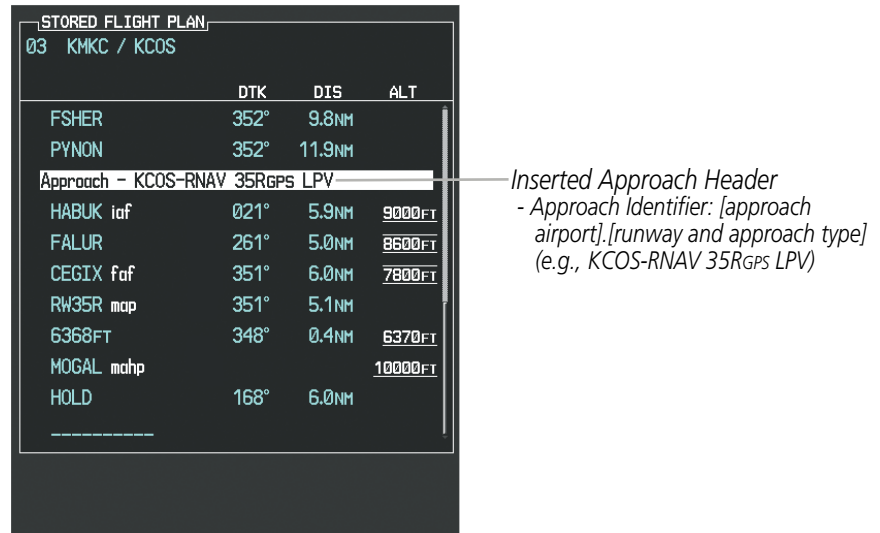

Figure 5-76 Stored Flight Plan Page - Approach Inserted

SYSTEM OVERVIEW

FLIGHT INSTRUMENTS

EIS

AUDIO PANEL & CNS

FLIGHT MANAGEMENT

HAZARD AVOIDANCE

AFCS

ADDITIONAL FEATURES

APPENDICES

INDEX

## FLIGHT PLAN STORAGE

The G1000 can store up to 99 flight plans, numbered 1 through 99. The active flight plan is erased when the G1000 is powered off or when another flight plan is activated. Details about each stored flight plan can be viewed on the Flight Plan Catalog Page and on the Stored Flight Plan Page.

### Viewing information about a stored flight plan:

- 1) Press the **FPL** Key on the MFD to display the Active Flight Plan Page.
- 2) Turn the small **FMS** Knob clockwise one click to display the Flight Plan Catalog Page.
- 3) Press the **FMS** Knob to activate the cursor and turn the **FMS** Knob to highlight the desired flight plan.
- 4) The Flight Plan Information is displayed showing departure, destination, total distance, and enroute safe altitude information for the selected Flight Plan.
- 5) Press the **EDIT** Softkey to open the Stored Flight Plan Page and view the waypoints in the flight plan.
- 6) Press the **FMS** Knob to exit the Stored Flight Plan Page.

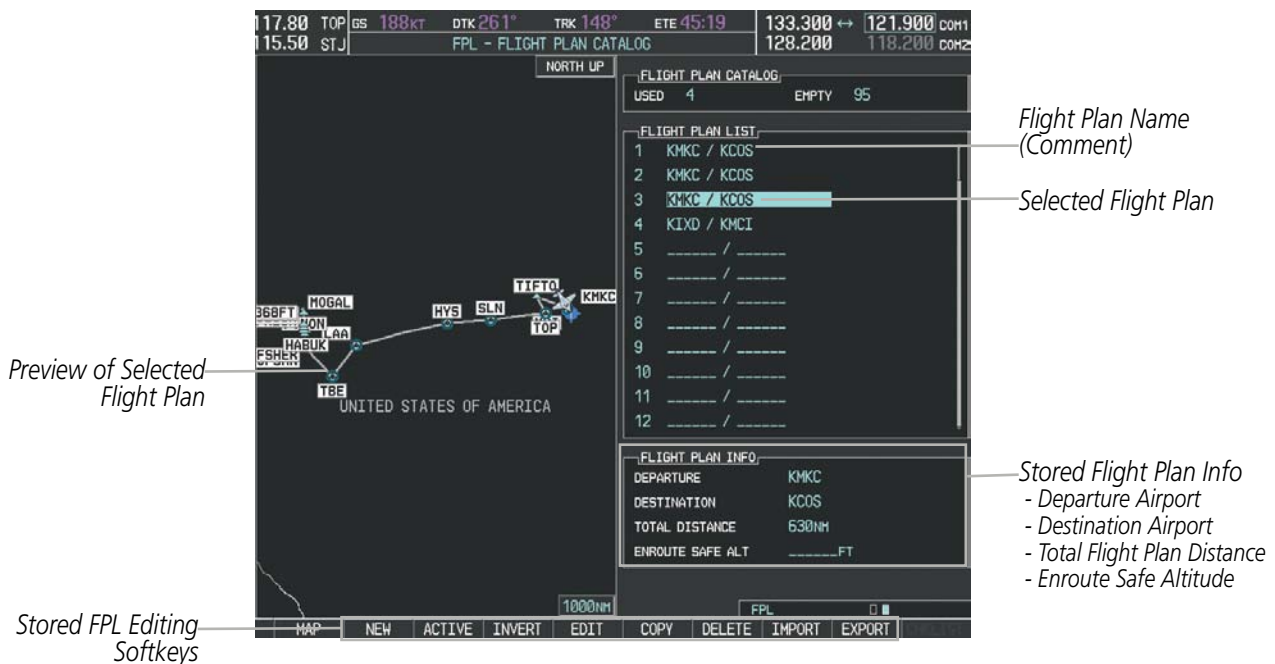

Figure 5-77 Stored Flight Plan Information

### Storing an active flight plan from the Active Flight Plan Page or the Active Flight Plan Window:

- 1) Press the **MENU** Key.
- 2) Highlight 'Store Flight Plan'.
- 3) Press the **ENT** Key.
- 4) With 'OK' highlighted, press the **ENT** Key. The flight plan is stored in the next available position in the flight plan list on the Flight Plan Catalog Page.

## SORT FLIGHT PLANS

The stored flight plans can be sorted alphanumerically based on the flight plan name (comment) assigned to each flight plan.

### Sorting by flight plan name (comment):

- 1) Press the **FPL** Key and turn the small **FMS** Knob to display the Flight Plan Catalog Page.
- 2) Press the **MENU** Key.
- 3) Highlight 'Sort By Comment' and press the **ENT** Key. A confirmation window is displayed.
- 4) With 'OK' highlighted, press the **ENT** Key to change flight plan ordering. To cancel the request, press the **CLR** Key, or highlight 'CANCEL' and press the **ENT** Key.

## ACTIVATE A FLIGHT PLAN

Activating a stored flight plan erases the active flight plan and replaces it with the flight plan being activated. Inverting a stored flight plan reverses the waypoint order, erases the active flight plan, and replaces it with the flight plan being activated (the stored flight plan is not changed).

### Activating a stored flight plan on the MFD:

- 1) Press the **FPL** Key and turn the small **FMS** Knob to display the Flight Plan Catalog Page.
- 2) Press the **FMS** Knob to activate the cursor, and turn the **FMS** Knob to highlight the desired flight plan.
- 3) Select the **ACTIVE** Softkey; or press the **ENT** Key twice; or press the **MENU** Key, highlight 'Activate Flight Plan', and press the **ENT** Key. The 'Activate Stored Flight Plan?' window is displayed.
- 4) With 'OK' highlighted, select the **ENT** Key. To cancel the request, press the **CLR** Key, or highlight 'CANCEL' and press the **ENT** Key.

### Inverting and activating a stored flight plan on the MFD:

- 1) Press the **FPL** Key and turn the small **FMS** Knob to display the Flight Plan Catalog Page.
- 2) Press the **FMS** Knob to activate the cursor, and turn the **FMS** Knob to highlight the desired flight plan.
- 3) Select the **INVERT** Softkey; or press the **MENU** Key, highlight 'Invert & Activate FPL?', and press the **ENT** Key. The 'Invert and activate stored flight plan?' window is displayed.
- 4) With 'OK' highlighted, press the **ENT** Key. To cancel the request, press the **CLR** Key, or highlight 'CANCEL' and press the **ENT** Key.

## COPY A FLIGHT PLAN

The G1000 allows copying a flight plan into a new flight plan memory slot, allowing editing, etc., without affecting the original flight plan. This can be used to duplicate an existing stored flight plan for use in creating a modified version of the original stored flight plan.

### Copying a stored flight plan on the MFD:

- 1) Press the **FPL** Key and turn the small **FMS** Knob to display the Flight Plan Catalog Page.
- 2) Press the **FMS** Knob to activate the cursor, and turn the **FMS** Knob to highlight the desired flight plan.

- 3) Select the **COPY** Softkey; or press the **MENU** Key, highlight 'Copy Flight Plan', and press the **ENT** Key. The 'Copy to Flight Plan XX?' window is displayed.
- 4) With 'OK' highlighted, press the **ENT** Key to copy the flight plan. To cancel the request, press the **CLR** Key, or highlight 'CANCEL' and press the **ENT** Key.

### DELETE A STORED FLIGHT PLAN

Individual or all stored flight plans can be deleted from the G1000 memory.

#### Deleting a stored flight plan:

- 1) Press the **FPL** Key and turn the small **FMS** Knob to display the Flight Plan Catalog Page.
- 2) Press the **FMS** Knob to activate the cursor, and turn the **FMS** Knob to highlight the desired flight plan.
- 3) Select the **DELETE** Softkey; press the **CLR** Key; or press the **MENU** Key, highlight 'Delete Flight Plan', and press the **ENT** Key. The 'Delete Flight Plan XX?' window is displayed.
- 4) With 'OK' highlighted, press the **ENT** Key to delete the flight plan. To cancel the request, press the **CLR** Key, or highlight 'CANCEL' and press the **ENT** Key.



**NOTE:** The option to delete all stored flight plans is not available while the aircraft is in flight.

#### Deleting all stored flight plans:

- 1) Press the **FPL** Key and turn the small **FMS** Knob to display the Flight Plan Catalog Page.
- 2) Press the **MENU** Key.
- 3) Highlight 'Delete All' and press the **ENT** Key. A 'Delete all flight plans?' confirmation window is displayed.
- 4) With 'OK' highlighted, press the **ENT** Key to delete all flight plans. To cancel the request, press the **CLR** Key, or highlight 'CANCEL' and press the **ENT** Key.

## FLIGHT PLAN EDITING

The active flight plan or any stored flight plan can be edited. The edits made to the active flight plan affect navigation as soon as they are entered.

### DELETING THE ACTIVE FLIGHT PLAN

The G1000 allows deleting an active flight plan. Deleting the active flight plan suspends navigation by the G1000.

#### Deleting the active flight plan:

- 1) Press the **FPL** Key to display the Active Flight Plan Page (MFD) or the Active Flight Plan Window (PFD).
- 2) Press the **MENU** Key, highlight 'Delete Flight Plan', and press the **ENT** Key. The 'Delete all waypoints in flight plan?' window is displayed.
- 3) With 'OK' highlighted, press the **ENT** Key to delete the active flight plan. To cancel the request, press the **CLR** Key, or highlight 'CANCEL' and press the **ENT** Key.

SYSTEM OVERVIEW

FLIGHT INSTRUMENTS

EIS

AUDIO PANEL & CNS

FLIGHT MANAGEMENT

HAZARD AVOIDANCE

AFCS

ADDITIONAL FEATURES

APPENDICES

INDEX



## DELETING FLIGHT PLAN ITEMS

Individual waypoints, entire airways, and entire procedures can be deleted from a flight plan. Some waypoints in the final approach segment (such as the FAF or MAP) can not be deleted individually. Attempting to delete a waypoint that is not allowed results in a window displaying 'Invalid flight plan modification.'

### Deleting an individual waypoint from the active flight plan:

- 1) Press the **FPL** Key to display the Active Flight Plan Page (MFD) or the Active Flight Plan Window (PFD).
- 2) Press the **FMS** Knob to activate the cursor (not required on the PFD) and turn the large **FMS** Knob to highlight the waypoint to be deleted.
- 3) Press the **CLR** Key. The 'Remove XXXXX?' window is displayed.
- 4) With 'OK' highlighted, press the **ENT** Key. To cancel the request, press the **CLR** Key, or highlight 'CANCEL' and press the **ENT** Key.
- 5) Press the **FMS** Knob to remove the flashing cursor.

### Deleting an entire airway from the active flight plan:

- 1) Press the **FPL** Key to display the Active Flight Plan Page (MFD) or the Active Flight Plan Window (PFD).
- 2) Press the **FMS** Knob to activate the cursor (not required on the PFD) and turn the large **FMS** Knob to highlight the white header of the airway to be deleted.
- 3) Press the **CLR** Key. The 'Remove <airway name>?' window is displayed.
- 4) With 'OK' highlighted, press the **ENT** Key. To cancel the request, press the **CLR** Key, or highlight 'CANCEL' and press the **ENT** Key.
- 5) Press the **FMS** Knob to remove the flashing cursor.

### Deleting an entire procedure from the active flight plan:

- 1) Press the **FPL** Key to display the Active Flight Plan Page (MFD) or the Active Flight Plan Window (PFD).
- 2) Press the **FMS** Knob to activate the cursor (not required on the PFD) and turn the large **FMS** Knob to highlight the white header of the procedure to be deleted.
- 3) Press the **CLR** Key. The 'Remove <procedure name> from flight plan?' window is displayed.
- 4) With 'OK' highlighted, press the **ENT** Key. To cancel the request, press the **CLR** Key, or highlight 'CANCEL' and press the **ENT** Key.
- 5) Press the **FMS** Knob to remove the flashing cursor.

Or:

- 1) Press the **FPL** Key to display the Active Flight Plan Page (MFD) or the Active Flight Plan Window (PFD).
- 2) Press the **MENU** Key to display the Page Menu and turn the **FMS** Knob to highlight 'Remove <procedure>'.  
3) Press the **ENT** Key. The 'Remove <procedure name> from flight plan?' window is displayed.
- 4) With 'OK' highlighted, press the **ENT** Key. To cancel the request, press the **CLR** Key, or highlight 'CANCEL' and press the **ENT** Key.

**Deleting an individual waypoint from a stored flight plan:**

- 1) Press the **FPL** Key to display the Active Flight Plan Page.
- 2) Turn the small **FMS** Knob clockwise one click to display the Flight Plan Catalog Page.
- 3) Press the **FMS** Knob to activate the cursor and turn the **FMS** Knob to highlight the flight plan to be edited.
- 4) Select the **EDIT** Softkey; or press the **MENU** Key, select 'Edit Flight Plan' and press the **ENT** Key. The Stored Flight Plan Page is displayed.
- 5) Turn the large **FMS** Knob to highlight the waypoint to be deleted.
- 6) Press the **CLR** Key. The 'Remove XXXXX?' window is displayed.
- 7) With 'OK' highlighted, press the **ENT** Key. To cancel the request, press the **CLR** Key, or highlight 'CANCEL' and press the **ENT** Key.
- 8) Press the **FMS** Knob to remove the flashing cursor.

**Deleting an entire airway from a stored flight plan:**

- 1) Press the **FPL** Key to display the Active Flight Plan Page.
- 2) Turn the small **FMS** Knob clockwise one click to display the Flight Plan Catalog Page.
- 3) Press the **FMS** Knob to activate the cursor and turn the **FMS** Knob to highlight the flight plan to be edited.
- 4) Select the **EDIT** Softkey; or press the **MENU** Key, select 'Edit Flight Plan' and press the **ENT** Key. The Stored Flight Plan Page is displayed.
- 5) Turn the large **FMS** Knob to highlight the white header of the airway to be deleted.
- 6) Press the **CLR** Key. The 'Remove <airway name>?' window is displayed.
- 7) With 'OK' highlighted, press the **ENT** Key. To cancel the request, press the **CLR** Key, or highlight 'CANCEL' and press the **ENT** Key.
- 8) Press the **FMS** Knob to remove the flashing cursor.

**Deleting an entire procedure from a stored flight plan:**

- 1) Press the **FPL** Key to display the Active Flight Plan Page.
- 2) Turn the small **FMS** Knob clockwise one click to display the Flight Plan Catalog Page.
- 3) Press the **FMS** Knob to activate the cursor and turn the **FMS** Knob to highlight the flight plan to be edited.
- 4) Select the **EDIT** Softkey; or press the **MENU** Key, select 'Edit Flight Plan' and press the **ENT** Key. The Stored Flight Plan Page is displayed.
- 5) Turn the large **FMS** Knob to highlight the white header of the procedure to be deleted.
- 6) Press the **CLR** Key. The 'Remove <procedure name> from flight plan?' window is displayed.
- 7) With 'OK' highlighted, press the **ENT** Key. To cancel the request, press the **CLR** Key, or highlight 'CANCEL' and press the **ENT** Key.
- 8) Press the **FMS** Knob to remove the flashing cursor.

**Or:**

- 1) Press the **FPL** Key to display the Active Flight Plan Page.
- 2) Turn the small **FMS** Knob clockwise one click to display the Flight Plan Catalog Page.
- 3) Press the **FMS** Knob to activate the cursor and turn the **FMS** Knob to highlight the flight plan to be edited.
- 4) Select the **EDIT** Softkey; or press the **MENU** Key, select 'Edit Flight Plan' and press the **ENT** Key. The Stored Flight Plan Page is displayed.
- 5) Press the **MENU** Key to display the Page Menu and turn the **FMS** Knob to highlight 'Remove <procedure>'.  
6) Press the **ENT** Key. The 'Remove <procedure name> from flight plan?' window is displayed.
- 7) With 'OK' highlighted, press the **ENT** Key. To cancel the request, press the **CLR** Key, or highlight 'CANCEL' and press the **ENT** Key.
- 8) Press the **FMS** Knob to remove the flashing cursor.

## CHANGING FLIGHT PLAN COMMENTS (NAMES)

The comment field (or name) of each flight plan can be changed to something that is useful for identification and sorting.

### Changing the active flight plan comment:

- 1) Press the **FPL** Key to display the Active Flight Plan Page.
- 2) Press the **FMS** Knob to activate the cursor and turn the large **FMS** Knob to highlight the comment field.
- 3) Use the **FMS** Knobs to edit the comment.
- 4) Press the **ENT** Key to accept the changes.
- 5) Press the **FMS** Knob to remove the flashing cursor.

### Changing a stored flight plan comment:

- 1) Press the **FPL** Key to display the Active Flight Plan Page.
- 2) Turn the small **FMS** Knob clockwise one click to display the Flight Plan Catalog Page.
- 3) Press the **FMS** Knob to activate the cursor and turn the **FMS** Knob to highlight the flight plan to be edited.
- 4) Select the **EDIT** Softkey; or press the **MENU** Key, select 'Edit Flight Plan' and press the **ENT** Key. The Stored Flight Plan Page is displayed.
- 5) Turn the large **FMS** Knob to highlight the comment field.
- 6) Use the **FMS** Knobs to edit the comment.
- 7) Press the **ENT** Key to accept the changes.
- 8) Press the **FMS** Knob to remove the flashing cursor.

## ALONG TRACK OFFSETS

A waypoint having an "along track offset" distance from an existing waypoint can be entered into a flight plan. Along track offset waypoints lie along the path of the existing flight plan, and can be used to make the system reach a specified altitude before or after reaching the specified flight plan waypoint. Offset distances can be

entered from 1 to 99 nm in increments of 1 nm. Entering a negative offset distance results in an along track offset waypoint inserted before the selected waypoint, whereas entering a positive offset distance results in an along track offset waypoint inserted after the selected waypoint. Multiple offset waypoints are allowed.

A waypoint must be adjacent to its parent waypoint in the flight plan, so the system limits the along-track distance to less than the length of the leg before or after the selected waypoint. If the selected waypoint is the active waypoint, the distance is limited to less than the distance to go to the active waypoint. Assigning an along track offset to a leg with indeterminate length is not permitted. An along track offset is not allowed at or after the final approach fix of an approach.

An along track offset distance cannot be modified once entered. If the along track offset distance must be changed, the existing along track offset waypoint must be deleted and a new one created with the new offset distance.

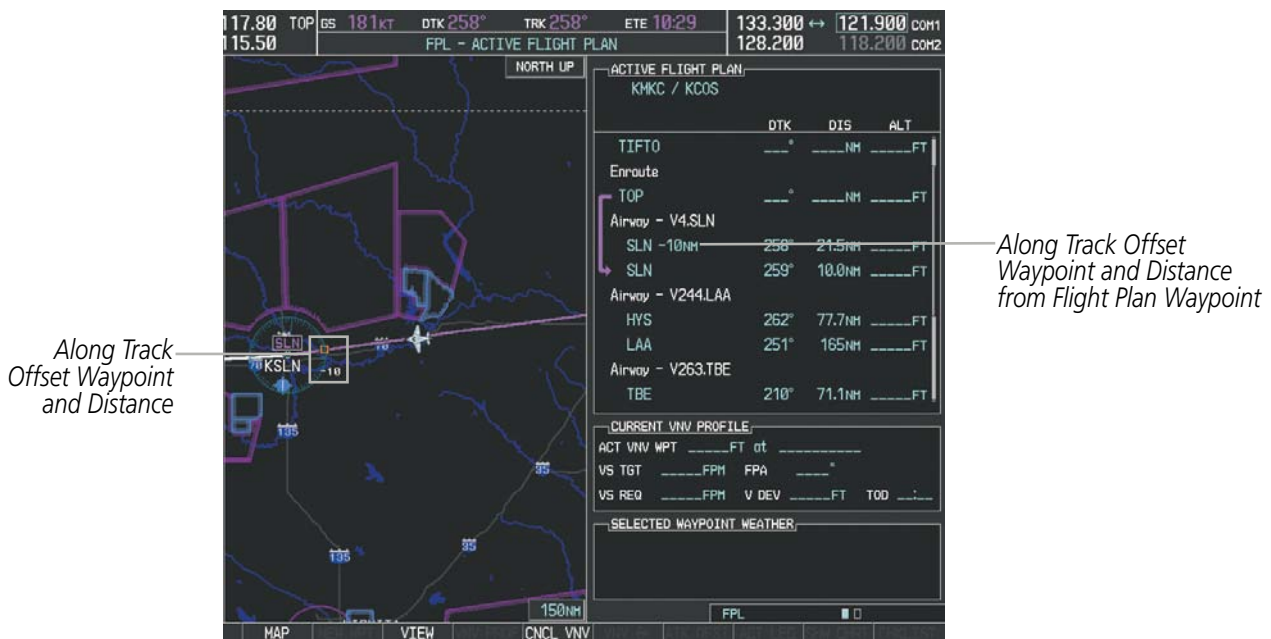

Figure 5-78 Along Track Offset

**Entering an along track offset distance:**

- 1) Press the **FPL** Key to display the Active Flight Plan Page (MFD) or the Active Flight Plan Window (PFD).
- 2) Press the **FMS** Knob to activate the cursor (not required on the PFD) and turn the large **FMS** Knob to highlight the waypoint for the along track offset.
- 3) Press the **ATK OFST** Softkey (MFD only); or press the **MENU** Key, highlight 'Create ATK Offset Waypoint', and press the **ENT** Key.
- 4) Enter a positive or negative offset distance in the range of +/- 1 to 99 nm (limited by leg distances).
- 5) Press the **ENT** Key to create the offset waypoint.
- 6) Turn the small **FMS** Knob to enter the desired altitude for the offset.
- 7) Press the **FMS** Knob to remove the flashing cursor.

## PARALLEL TRACK

The Parallel Track (PTK) feature allows creation of a parallel course offset of 1 to 50 nm left or right of the current flight plan. When Parallel Track is activated, the course line drawn on the map pages shows the parallel course, and waypoint names have a lower case “p” placed after the identifier.

Using direct-to, loading an approach, a holding pattern, or editing and activating the flight plan automatically cancels Parallel Track. Parallel Track is also cancelled if a course change occurs greater than 120° or the parallel tracks overlap as a result of the course change.



**NOTE:** Vertical navigation is unavailable while the Parallel Track feature is active.

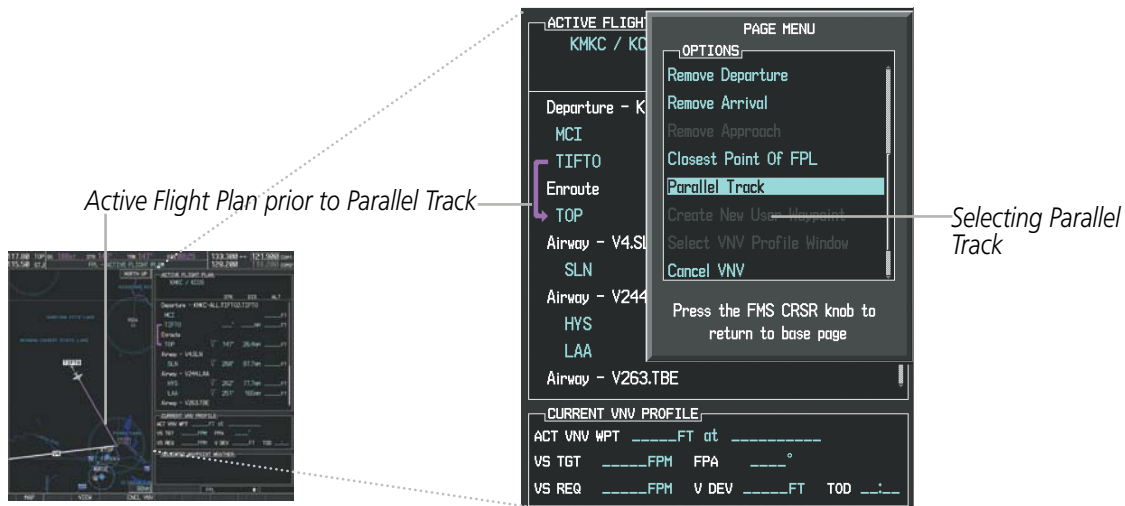

Figure 5-79 Active Flight Plan Window - Selecting Parallel Track

### Activating parallel track:

- 1) Press the **FPL** Key to display the Active Flight Plan Page (MFD) or the Active Flight Plan Window (PFD).
- 2) Press the **MENU** Key, highlight 'Parallel Track', and press the **ENT** Key. The Parallel Track Window is displayed with the direction field highlighted.
- 3) Turn the small **FMS** Knob to select 'Left' or 'Right' and press the **ENT** Key. The 'DISTANCE' field is highlighted.
- 4) Turn the small **FMS** Knob to enter a distance from 1-99 nm and press the **ENT** Key. 'ACTIVATE PARALLEL TRACK' is highlighted.
- 5) Press the **ENT** Key to activate parallel track. Press the **FMS** Knob or the **CLR** Key to cancel the parallel track activation.

- SYSTEM OVERVIEW
- FLIGHT INSTRUMENTS
- EIS
- AUDIO PANEL & CNS
- FLIGHT MANAGEMENT
- HAZARD AVOIDANCE
- AFCS
- ADDITIONAL FEATURES
- APPENDICES
- INDEX

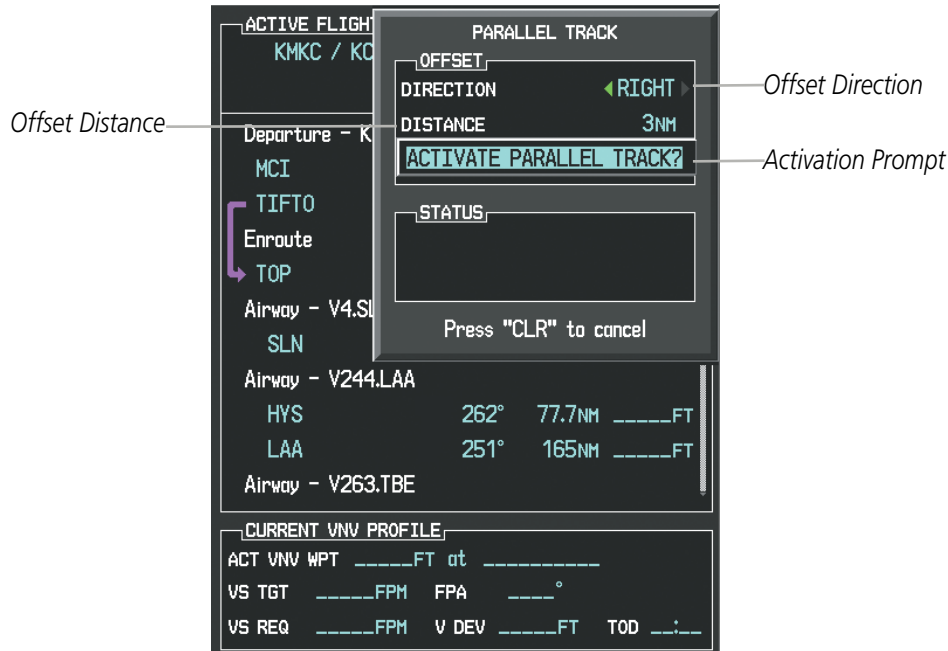

Figure 5-80 Parallel Track Window

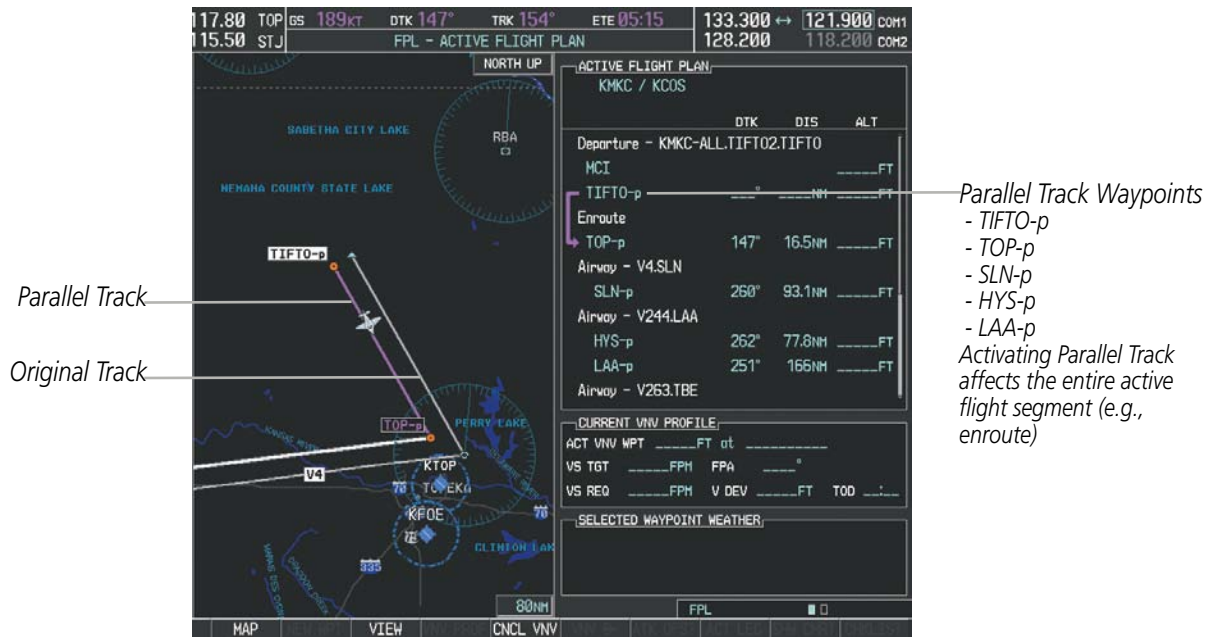

Figure 5-81 Parallel Track Active

If the parallel track proposed by the offset direction and distance is not allowed by the system, the activation prompt is displayed, but disabled. Parallel Track cannot be activated if a course is set using direct-to or if the active leg is the first leg of the departure procedure. Attempting to activate parallel track with these conditions results in the message 'Parallel Track Unavailable Invalid Route Geometry'. If an approach leg is active the status



indicates that the system is unable to activate the parallel track with the message 'Parallel Track Unavailable Approach Leg Active'. If the offset direction and distance results in an unreasonable route geometry the status indicates that the system is unable to activate the parallel track because of invalid geometry.

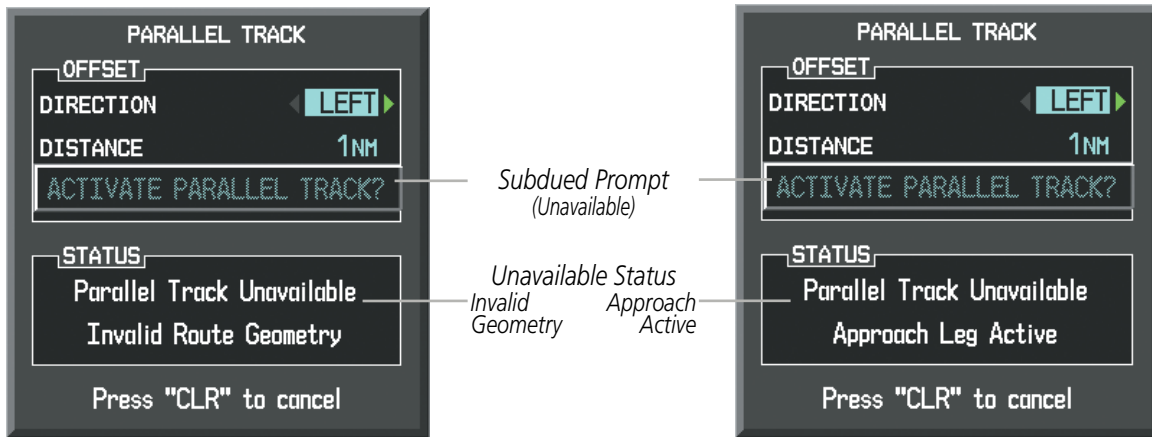

Figure 5-82 Parallel Track Unavailable

If the active leg is not a track between two fixes (TF) or a course to a fix (DF) leg, the status indicates that the system is unable to activate the parallel track because parallel track is not available for the active leg type.

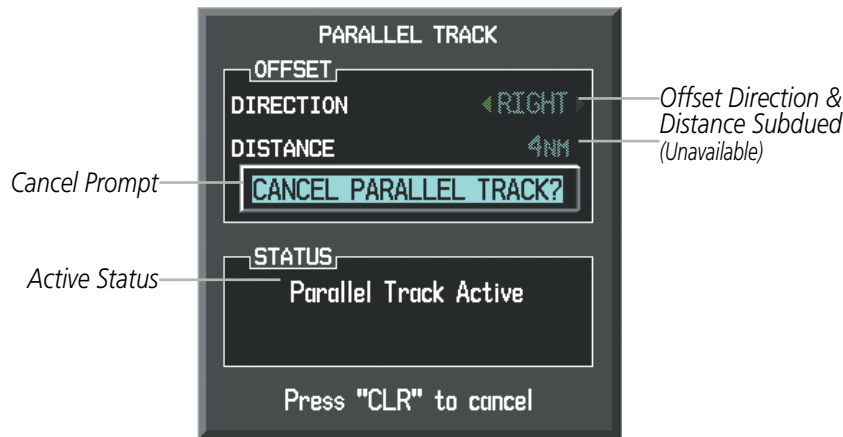

Figure 5-83 Cancelling Parallel Track

**Cancelling parallel track:**

- 1) Press the **FPL** Key to display the Active Flight Plan Page (MFD) or the Active Flight Plan Window (PFD).
- 2) Press the **MENU** Key, highlight 'Parallel Track', and press the **ENT** Key. The Parallel Track Window is displayed with 'CANCEL PARALLEL TRACK?' highlighted.
- 3) Press the **ENT** Key.



## ACTIVATING A FLIGHT PLAN LEG

The G1000 allows selection of a highlighted leg as the “active leg” (the flight plan leg which is currently used for navigation guidance).

### Activating a flight plan leg:

- 1) Press the **FPL** Key to display the Active Flight Plan Page (MFD) or the Active Flight Plan Window (PFD).
- 2) Press the **FMS** Knob to activate the cursor (not required on the PFD) and turn the large **FMS** Knob to highlight the destination waypoint for the desired leg.
- 3) Select the **ACT LEG** Softkey (MFD only); or press the **MENU** Key, highlight ‘Activate Leg’, and press the **ENT** Key. A confirmation window is displayed with ‘ACTIVATE’ highlighted.
- 4) Press the **ENT** Key to activate the flight plan leg. To cancel, press the **CLR** Key, or highlight ‘CANCEL’ and press the **ENT** Key.
- 5) Press the **FMS** Knob to remove the flashing cursor.

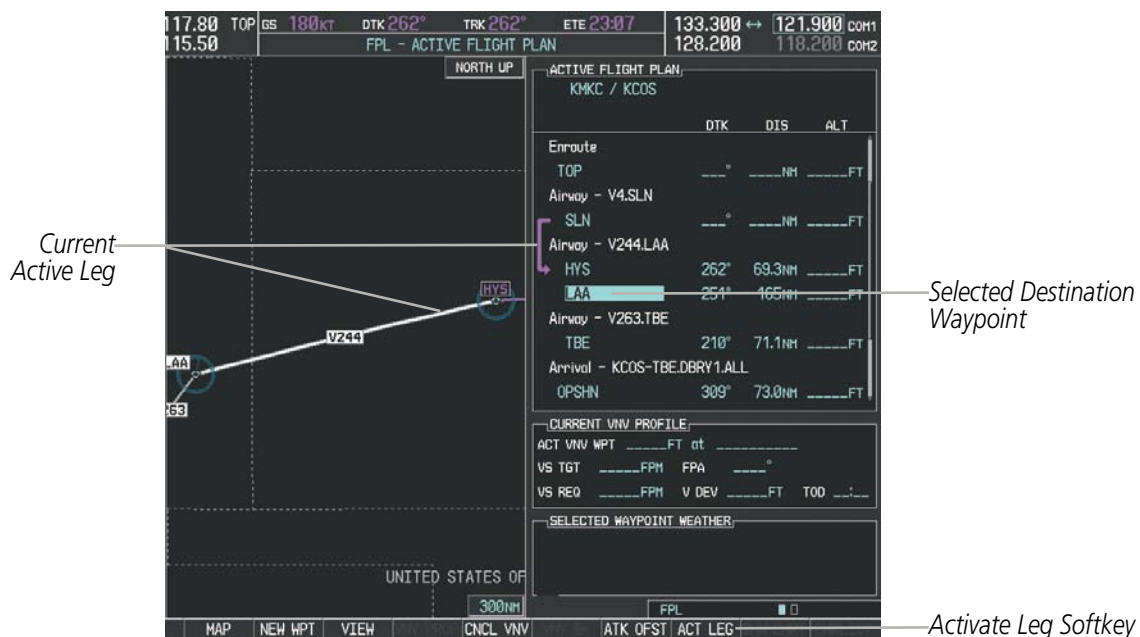

Figure 5-84 Active Flight Plan Page - Selecting the Leg Destination Waypoint

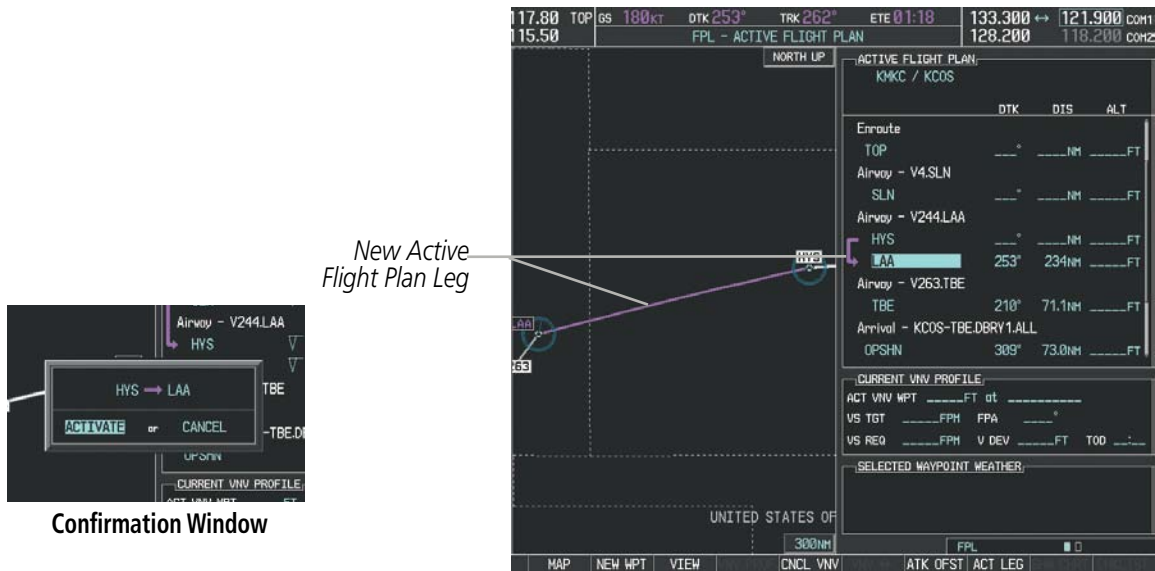

Figure 5-85 Active Flight Plan Page - New Active Leg

## INVERTING A FLIGHT PLAN

Any flight plan may be inverted (reversed) for navigation back to the original departure point.

### Inverting the active flight plan:

- 1) Press the **FPL** Key to display the Active Flight Plan Page (MFD) or the Active Flight Plan Window (PFD).  
2) Press the **MENU** Key, highlight 'Invert Flight Plan', and press the **ENT** Key. An 'Invert Active Flight Plan?' confirmation window is displayed.
- 3) Select 'OK'.
- 4) Press the **ENT** Key to invert and activate the active flight plan. To cancel, press the **CLR** Key, or highlight 'CANCEL' and press the **ENT** Key.

### Inverting and activating a stored flight plan:

- 1) Press the **FPL** Key and turn the small **FMS** Knob to display the Flight Plan Catalog Page.
- 2) Press the **FMS** Knob to activate the cursor, and turn the **FMS** Knob to highlight the desired flight plan.
- 3) Select the **INVERT** Softkey; or press the **MENU** Key, highlight 'Invert & Activate FPL?', and press the **ENT** Key. The 'Invert and activate stored flight plan?' window is displayed.
- 4) With 'OK' highlighted, press the **ENT** Key. To cancel the request, press the **CLR** Key, or highlight 'CANCEL' and press the **ENT** Key.

## FLIGHT PLAN VIEWS

Information about flight plans can be viewed in more than one way. The active flight plan can be configured to show cumulative distance over the length of the flight plan or the distance for each leg of the flight plan; and the active flight plan can be viewed in a narrow or wide view. In the wide view, additional information is displayed: Fuel Remaining (FUEL REM), Estimated Time Enroute (ETE), Estimated Time of Arrival (ETA), and Bearing to the waypoint (BRG).

### Switching between leg-to-leg waypoint distance and cumulative waypoint distance:

- 1) Press the **FPL** Key on the MFD to display the Active Flight Plan Page.
- 2) Press the **VIEW** Softkey to display the **CUM** and **LEG-LEG** Softkeys.
- 3) Press the **CUM** Softkey to view cumulative waypoint distance, or press the **LEG-LEG** Softkey to view leg-to-leg waypoint distance.
- 4) Press the **BACK** Softkey to return to the top level active flight plan softkeys.

Active Flight Plan Leg to Leg Distance

Active Flight Plan Cumulative Distance

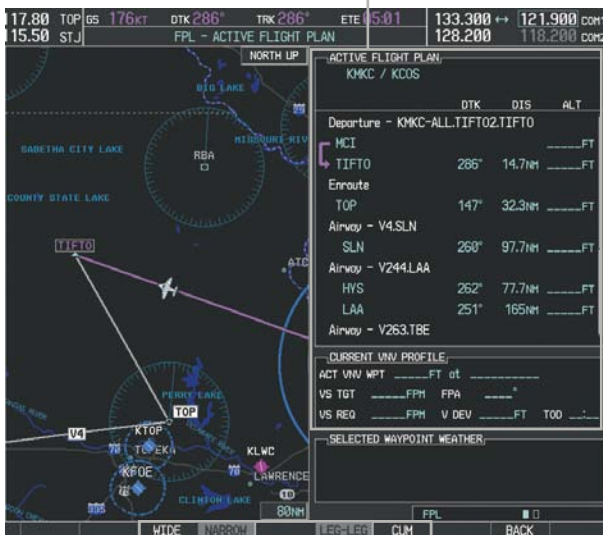

Flight Plan View Softkeys  
WIDE, NARROW, LEG-LEG, CUM

Flight Plan View Softkeys  
WIDE, NARROW, LEG-LEG, CUM

Figure 5-86 Active Flight Plan - Leg to Leg vs. Cumulative Distance

### Switching between wide and narrow view:

- 1) Press the **FPL** Key on the MFD to display the Active Flight Plan Page.
- 2) Press the **VIEW** Softkey to display the **WIDE** and **NARROW** Softkeys.
- 3) Press the **WIDE** Softkey to display the wide view, or press the **NARROW** Softkey to display the narrow view.
- 4) Press the **BACK** Softkey to return to the top level active flight plan softkeys.



Figure 5-87 Active Flight Plan - Wide vs. Narrow View

### COLLAPSING AIRWAYS

The G1000 allows airways on the active flight plan to be collapsed or expanded from the Active Flight Plan Page/Window. When airways have been collapsed, it is indicated on the airway heading.

When airways are collapsed, leg-to-leg computed values such as DIS or ETE shown for the exit waypoint reflect the total of all the legs on the airway that have been hidden in the collapsed display. The DTK value is inhibited because it is not usable in this context.

The Active Flight Plan Page always keeps the following three waypoints visible: “From” waypoint, “To” waypoint, and “Next” waypoint. To prevent one or more of these waypoints from being hidden in a collapsed airway segment, the airway segment that contains either the “To” or the “Next” waypoint is automatically expanded. When an airway is loaded, airways are automatically expanded to facilitate flight plan review.

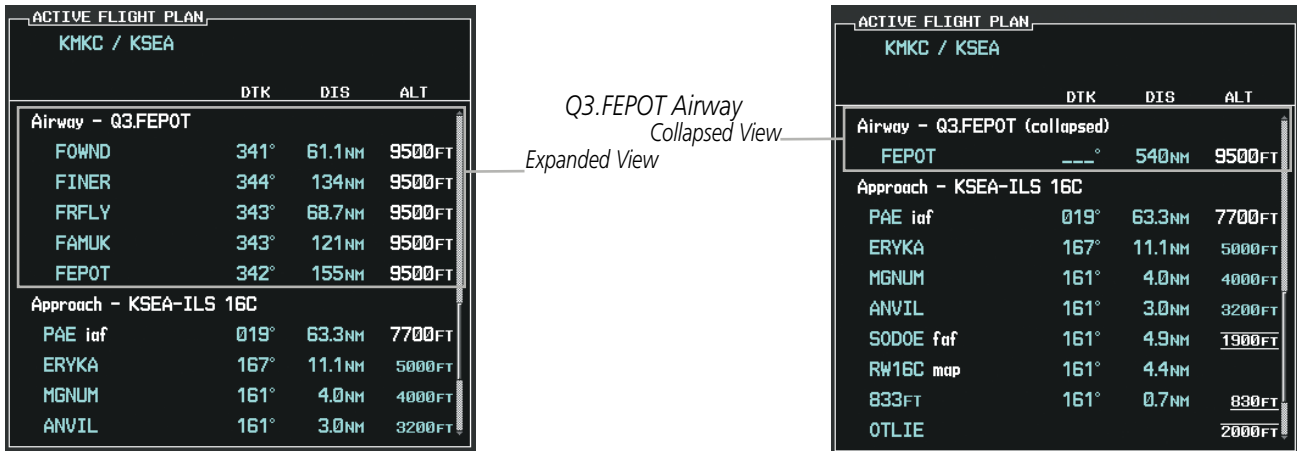

Figure 5-88 Expanded/Collapsed Airways

**Collapsing/expanding the airways in the active flight plan:**

- 1) Press the **FPL** Key to display the Active Flight Plan Page (MFD) or the Active Flight Plan Window (PFD).
- 2) Press the **MENU** Key, highlight 'Collapse Airways' or 'Expand Airways', and press the **ENT** Key. The airways are collapsed/expanded.

**CLOSEST POINT OF FPL**

'Closest Point of FPL' calculates the bearing and closest distance at which a flight plan passes a reference waypoint, and creates a new user waypoint along the flight plan at the location closest to a chosen reference waypoint.

**Determining the closest point along the active flight plan to a selected waypoint:**

- 1) Press the **FPL** Key to display the Active Flight Plan Page (MFD) or the Active Flight Plan Window (PFD).
- 2) Press the **MENU** Key, highlight 'Closest Point Of FPL', and press the **ENT** Key. A window appears with the reference waypoint field highlighted.
- 3) Enter the identifier of the reference waypoint and press the **ENT** Key. The G1000 displays the bearing (BRG) and distance (DIS) to the closest point along the flight plan to the selected reference waypoint and creates a user waypoint at this location. The name for the new user waypoint is derived from the identifier of the reference waypoint.



## 5.7 VERTICAL NAVIGATION



**NOTE:** The G1000 supports vertical navigation for all lateral leg types except for CA, CI, FA, FM, HA, HM, PI, VA, VD, VI, VR, and VM. Vertical constraints are not retained in stored flight plans.

The G1000 system Vertical Navigation (VNV) feature provides vertical profile guidance during the enroute and terminal phases of flight. Guidance based on specified altitudes at waypoints in the active flight plan or to a direct-to waypoint is provided. It includes vertical path guidance to a descending path, which is provided as a linear deviation from the desired path. The desired path is defined by a line joining two waypoints with specified altitudes or as a vertical angle from a specified waypoint/altitude. The vertical waypoints are integrated into the active flight plan. Both manual and autopilot-coupled guidance are supported.

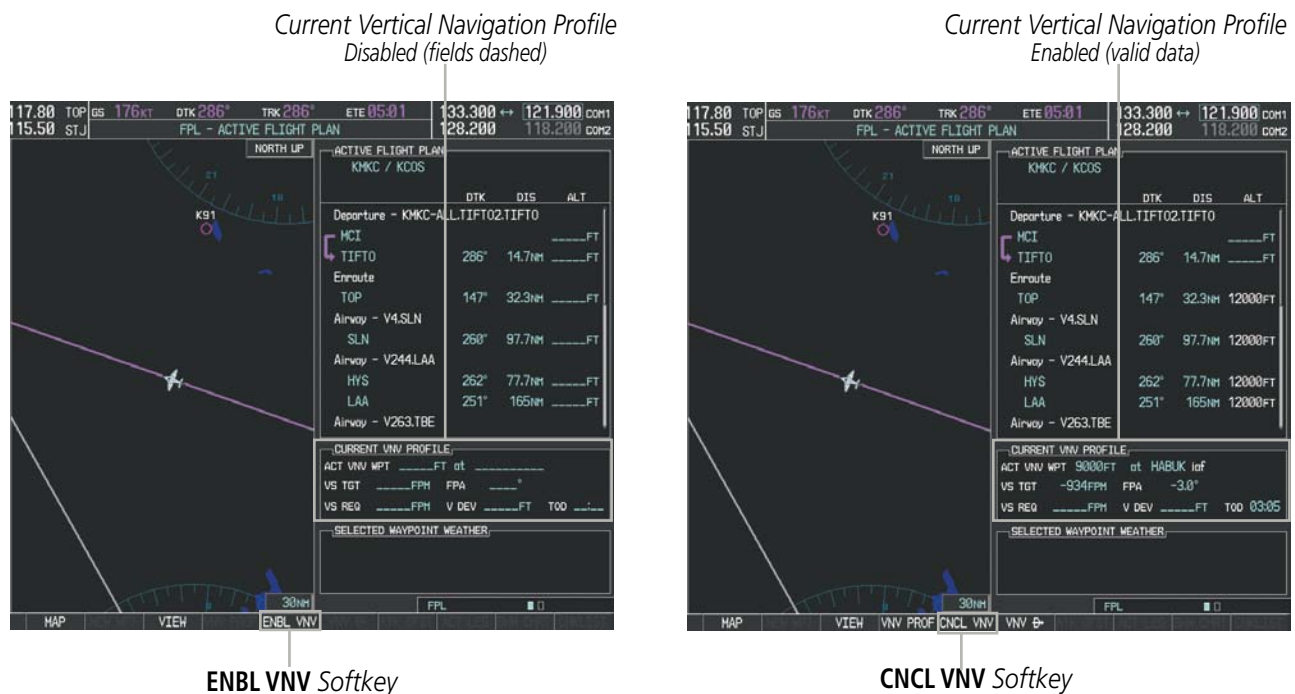

Figure 5-89 Enabling/Disabling Vertical Navigation

### Enabling VNV guidance:

- 1) Press the **FPL** Key to display the Active Flight Plan Page on the MFD.
- 2) Press the **ENBL VNV** Softkey; or press the **MENU** Key, highlight 'Enable VNV', and press the **ENT** Key. Vertical navigation is enabled, and vertical guidance begins with the waypoint shown in the CURRENT VNV PROFILE box (defaults first waypoint in the active flight plan with an altitude enabled for vertical navigation (e.g., HABUK)).

### Disabling VNV guidance:

- 1) Press the **FPL** Key to display the Active Flight Plan Page on the MFD.
- 2) Press the **CNCL VNV** Softkey; or press the **MENU** Key, highlight 'Cancel VNV', and press the **ENT** Key. Vertical navigation is disabled.

Canceling vertical navigation results in vertical deviation (V DEV), vertical speed required (VS REQ), and time to top of descent/bottom of descent (TIME TO TOD/BOD) going invalid. The Vertical Deviation Indicator (VDI) and Required Vertical Speed Indicator (RVSI) on the PFD are removed, and the V DEV, VS REQ, and TIME TO TOD items displayed in the CURRENT VNV PROFILE box are dashed. VNV remains disabled until manually enabled. Vertical guidance in reversionary mode can only be enabled for a direct-to waypoint.

The G1000 allows a vertical navigation direct-to to any waypoint in the active flight plan with an altitude constraint “designated” for vertical guidance. Selecting the **VNV Direct-to** Softkey on the Active Flight Plan Page allows the flight plan to be flown, while vertical guidance based on the altitude constraint at the VNV direct-to waypoint is provided. The altitude change begins immediately and is spread along the flight plan from current position to the vertical direct-to waypoint, not just along the leg for the direct-to waypoint. A direct-to with altitude constraint activated by pressing the **Direct-to** Key also provides vertical guidance, but would bypass flight plan waypoints between the current position in the flight plan and the direct-to waypoint. A top of descent (TOD) point is computed based on the default flight path angle; descent begins once the TOD is reached.

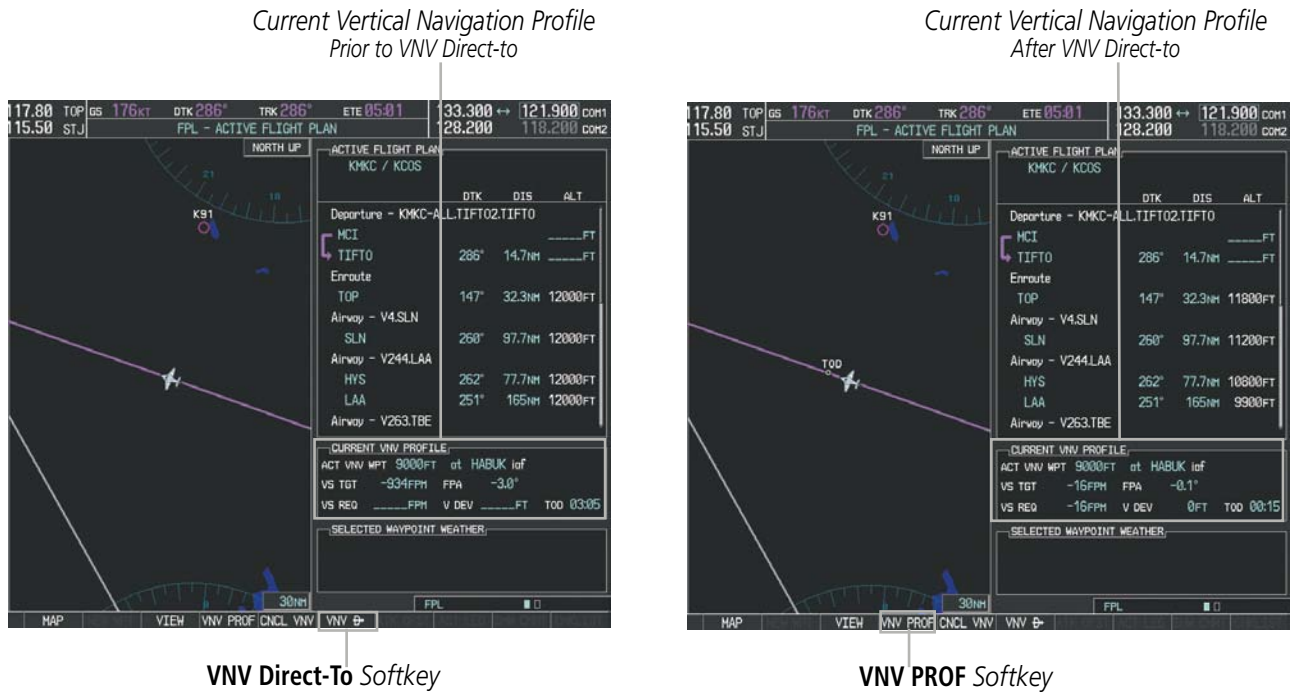

Figure 5-90 Vertical Navigation Direct-To

**Activating a vertical navigation direct-to:**

- 1) Press the **FPL** Key to display the Active Flight Plan Page on the MFD.
- 2) Press the **FMS** Knob to activate the cursor and turn the **FMS** Knob to highlight the desired waypoint.



**NOTE:** The selected waypoint must have a designated altitude constraint (light blue number) to be used. If not, the first waypoint in the flight plan with a designated altitude constraint is selected.



- 3) Press the **VNV Direct-To** Softkey; or press the **MENU** Key, highlight 'VNV Direct-To', and press the **ENT** Key. An 'Activate vertical Direct-to to: NNNNNFT at XXXXXX?' confirmation window is displayed.
- 4) Press the **ENT** Key. Vertical guidance begins to the altitude constraint for the selected waypoint.
- 5) Press the **FMS** Knob to remove the flashing cursor.

The vertical navigation profile can be modified by directly entering a vertical speed target (VS TGT) and/or flight path angle (FPA) in the CURRENT VNV PROFILE box.

**Modifying the VS TGT and FPA:**

- 1) Press the **FPL** Key to display the Active Flight Plan Page on the MFD.
- 2) Press the **VNV PROF** Softkey; or press the **MENU** Key, highlight 'Select VNV Profile Window', and press the **ENT** Key. The cursor is now located in the CURRENT VNV PROFILE box.
- 3) Turn the **FMS** Knobs as needed to edit the values.
- 4) Press the **FMS** Knob to remove the flashing cursor.

**ALTITUDE CONSTRAINTS**

The G1000 system can use altitude constraints associated with lateral waypoints to give guidance for vertical navigation. These altitudes are, depending on the specific instance, manually entered or retrieved from the published altitudes in the navigation database. The navigation database only contains altitudes for procedures that call for "Cross at" altitudes. If the procedure states "Expect to cross at," then the altitude is not in the database. In this case the altitude may be entered manually.

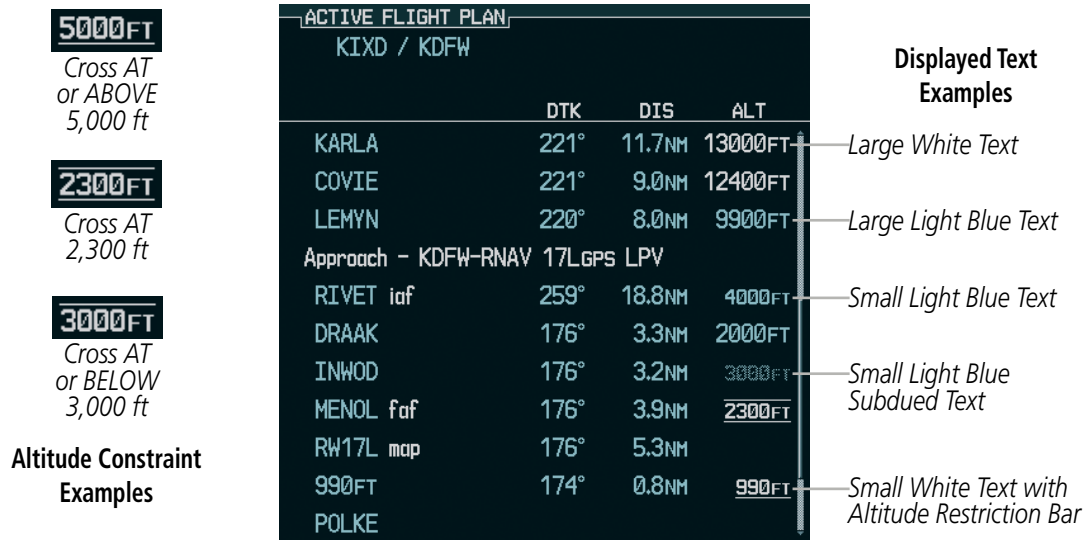

Figure 5-91 Waypoint Altitude Constraints

	White Text	Light Blue Text	Light Blue Subdued Text
<b>Large Text</b>	Altitude calculated by the system estimating the altitude of the aircraft as it passes over the navigation point. This altitude is provided as a reference and is not designated to be used in determining vertical speed and deviation guidance.	Altitude has been entered manually. Altitude is designated for use in giving vertical speed and deviation guidance. Altitude does not match the published altitude in navigation database or no published altitude exists.	The system cannot use this altitude in determining vertical speed and deviation guidance because of an invalid constraint condition.
<b>Small Text</b>	Altitude is not designated to be used in determining vertical speed and deviation guidance. Altitude has been retrieved from the navigation database and is provided as a reference.	Altitude is designated for use in giving vertical speed and deviation guidance. Altitude has been retrieved from the navigation database or has been entered manually and matches a published altitude in the navigation database.	The system cannot use this altitude in determining vertical speed and deviation guidance because of an invalid constraint condition.

**Table 5-8 Altitude Constraint Size and Color Coding**

Altitudes associated with approach procedures are “auto-designated”. This means the system automatically uses the altitudes loaded with the approach for giving vertical speed and deviation guidance. Note that these altitudes are displayed as blue text up to, but not including, the FAF. The FAF is always a “reference only” altitude and cannot be designated, unless the selected approach does not provide vertical guidance. In this case, the FAF altitude can be designated.

Altitudes that have been designated for use in vertical guidance can be “un-designated” using the **CLR** Key. The altitude is now displayed only as a reference. It is not used to give vertical guidance. Other displayed altitudes may change due to re-calculations or be rendered invalid as a result of manually changing an altitude to a non-designated altitude.

**Designating a waypoint altitude to be used for vertical guidance:**

- 1) Press the **FPL** Key to display the Active Flight Plan Page on the MFD.
- 2) Press the **FMS** Knob, and turn to highlight the desired waypoint altitude.
- 3) Turn the small **FMS** Knob to enter editing mode.
- 4) Press the **ENT** Key. The altitude is now shown in blue, indicating it is usable for vertical guidance.

**Designating a procedure waypoint altitude to be used for vertical guidance:**

- 1) Press the **FPL** Key to display the Active Flight Plan Page on the MFD.
- 2) Press the **FMS** Knob, and turn to highlight the desired waypoint altitude.
- 3) Press the **ENT** Key. The altitude is now shown in blue, indicating it is usable for vertical guidance.

Altitude constraints are displayed and entered in feet mean sea level (MSL) values to the nearest hundred. An altitude constraint in feet above ground level (AGL) format is supported for airports. When a database altitude restriction is displayed, the G1000 allows entry of a different altitude when creating a waypoint, effectively overriding the database restriction (only before the FAF). When a database altitude restriction of type “AT or ABOVE” or “AT or BELOW” is activated, the system uses the “AT” portion of the restriction to define the vertical profile.

- SYSTEM OVERVIEW
- FLIGHT INSTRUMENTS
- EIS
- AUDIO PANEL & CNS
- FLIGHT MANAGEMENT
- HAZARD AVOIDANCE
- AFCS
- ADDITIONAL FEATURES
- APPENDICES
- INDEX

An altitude constraint is invalid if:

- Meeting the constraint requires the aircraft to climb
- Meeting the constraint requires the maximum flight path angle or maximum vertical speed to be exceeded
- The altitude constraint results in a TOD behind the aircraft present position
- The constraint is within a leg type for which altitude constraints are not supported
- The altitude constraint is added to the FAF of an approach that provides vertical guidance (i.e., ILS or GPS SBAS approach)
- The altitude constraint is added to a waypoint past the FAF

#### Entering/modifying an altitude constraint:

- 1) Press the **FPL** Key to display the Active Flight Plan Page on the MFD.
- 2) Press the **FMS** Knob, and turn to highlight the desired waypoint altitude constraint.
- 3) Enter an altitude constraint value using the **FMS** Knobs. To enter altitudes as a flight level, turn the small **FMS** Knob counter-clockwise past zero or clockwise past 9 on the first character, and the system automatically changes to show units of Flight Level. Turn the large **FMS** Knob clockwise to highlight the first zero and enter the three digit flight level.
- 4) Press the **ENT** Key to accept the altitude constraint; if the selected waypoint is an airport, an additional choice is displayed. Turn the small **FMS** Knob to choose 'MSL' or 'AGL', and press the **ENT** Key to accept the altitude.

Altitude constraints can be modified or deleted after having been added to the flight plan. In the event an altitude constraint is deleted and the navigation database contains an altitude restriction for the lateral waypoint, the G1000 displays the altitude restriction from the database provided no predicted altitude can be provided. The G1000 also provides a way to reinstate a published altitude constraint that has been edited.

#### Deleting an altitude constraint provided by the navigation database:

- 1) Press the **FPL** Key to display the Active Flight Plan Page on the MFD.
- 2) Press the **FMS** Knob, and turn to highlight the desired waypoint altitude constraint.
- 3) Press the **CLR** Key. A 'Remove VNV altitude constraint?' confirmation window is displayed.
- 4) Select 'OK' and press the **ENT** Key.

#### Deleting an altitude constraint that has been manually entered:

- 1) Press the **FPL** Key to display the Active Flight Plan Page on the MFD.
- 2) Press the **FMS** Knob, and turn to highlight the desired waypoint altitude constraint.
- 3) Press the **CLR** Key. A 'Remove or Revert to published VNV altitude of nnnnnFT?' confirmation window is displayed.
- 4) Select 'REMOVE' and press the **ENT** Key. The manually entered altitude is deleted (it is replaced by a system calculated altitude, if available).

**Reverting a manually entered altitude constraint back to the navigation database value:**

- 1) Press the **FPL** Key to display the Active Flight Plan Page on the MFD.
- 2) Press the **FMS** Knob, and turn to highlight the desired waypoint altitude constraint.
- 3) Press the **CLR** Key. A 'Remove or Revert to published VNV altitude of nnnnnFT?' confirmation window is displayed.
- 4) Select 'REVERT' and press the **ENT** Key. The altitude is changed to the navigation database value.
- 5) Press the **FMS** Knob to remove the flashing cursor.

**Modifying a system calculated altitude constraint:**

- 1) Press the **FPL** Key to display the Active Flight Plan Page on the MFD.
- 2) Press the **FMS** Knob, and turn to highlight the desired waypoint altitude constraint.
- 3) Press the **CLR** Key. An 'Edit or Revert to published VNV altitude of nnnnnFT?' confirmation window is displayed.
- 4) Select 'EDIT' and press the **ENT** Key.
- 5) Edit the value using the **FMS** Knobs, and press the **ENT** Key.
- 6) Press the **FMS** Knob to remove the flashing cursor.

## 5.8 PROCEDURES

The G1000 can access the whole range of instrument procedures available. Departures (DPs), arrivals (STARs), and non-precision and precision approaches (APPRs) are stored within the database and can be loaded using the Procedures (**PROC**) Key.

The selected procedure for the departure or arrival airport is added to the active flight plan. No waypoints are required to be in the active flight plan to load procedures; however, if the departure and arrival airport are already loaded, the procedure loading window defaults to the appropriate airport, saving some time selecting the correct airport on the Procedure Loading Page. Whenever an approach is selected, the choice to either “load” or “activate” is given. “Loading” adds the approach to the end of the flight plan without immediately using it for navigation guidance. This allows continued navigation via the intermediate waypoints in the original flight plan, but keeps the procedure available on the Active Flight Plan Page for quick activation when needed. “Activating” also adds the procedure to the end of the flight plan but immediately begins to provide guidance to the first waypoint in the approach.

### DEPARTURES

A Departure Procedure (DP) is loaded at the departure airport in the flight plan. Only one departure can be loaded at a time in a flight plan. If a departure is loaded when another departure is already in the active flight plan, the new departure replaces the previous departure. The route is defined by selection of a departure, the transition waypoints, and a runway.

#### LOADING A DEPARTURE INTO THE ACTIVE FLIGHT PLAN

##### Loading a departure into the active flight plan using the **PROC** Key:

- 1) Press the **PROC** Key. The Procedures Window is displayed.
- 2) Highlight ‘SELECT DEPARTURE’.
- 3) Press the **ENT** Key. The Departure Loading Page is displayed.
- 4) Use the **FMS** Knob to select an airport and press the **ENT** Key.
- 5) Select a departure from the list and press the **ENT** Key.
- 6) Select a runway (if required) and press the **ENT** Key.
- 7) Select a transition (if required) and press the **ENT** Key. ‘LOAD?’ is highlighted.
- 8) Press the **ENT** Key to load the departure procedure.

SYSTEM OVERVIEW  
 FLIGHT INSTRUMENTS  
 EIS  
 AUDIO PANEL & CNS  
 FLIGHT MANAGEMENT  
 HAZARD AVOIDANCE  
 AFCS  
 ADDITIONAL FEATURES  
 APPENDICES  
 INDEX

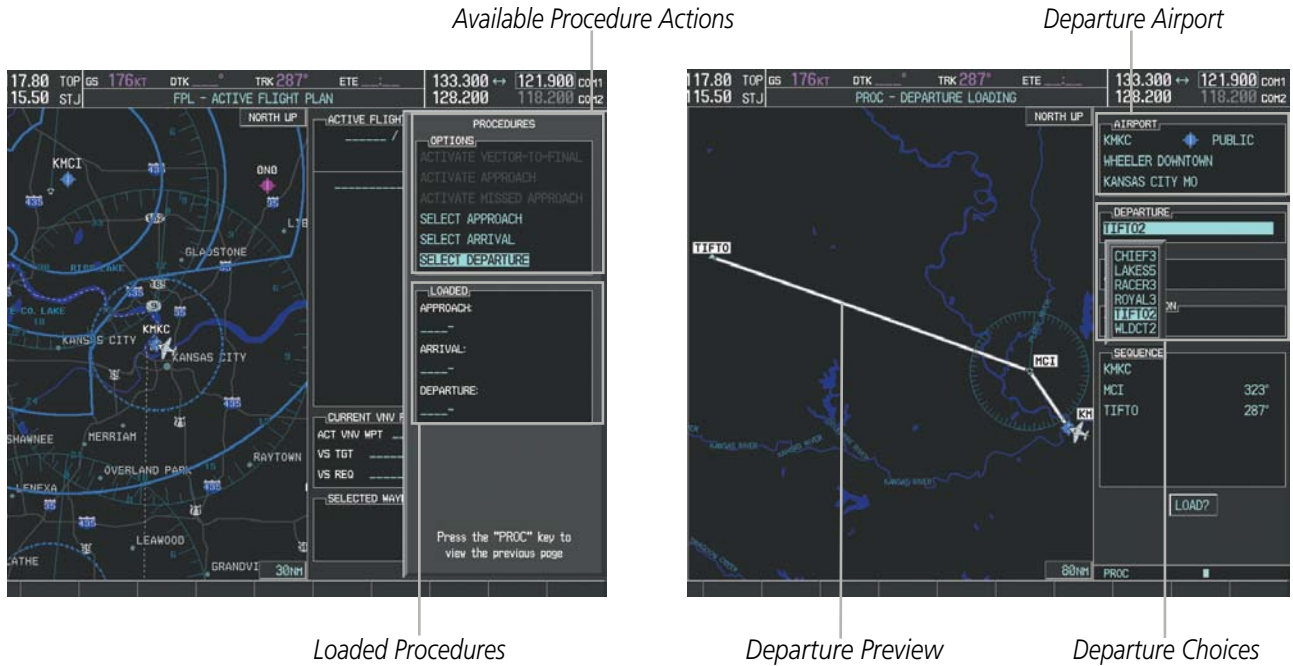

Figure 5-92 Departure Selection



Procedure Loading Page Selection Softkeys

Figure 5-93 Departure Loading

**Viewing available departures at an airport:**

- 1) From the Airport Information Page (first page in the WPT group), select the **DP** Softkey. The Departure Information Page is displayed, defaulting to the airport displayed on the Airport information Page.
- 2) To select another airport, press the **FMS** Knob to activate the cursor, enter an identifier/facility name/city, and press the **ENT** Key.
- 3) Turn the large **FMS** Knob to highlight the Departure. The departure is previewed on the map.
- 4) Turn the small **FMS** Knob to view the available departures. Press the **ENT** Key to select the departure. The cursor moves to the Runway box. The departure is previewed on the map.
- 5) Turn the small **FMS** Knob to view the available runways. Press the **ENT** Key to select the runway. The cursor moves to the Transition box (only if there are available transitions). The departure is previewed on the map.
- 6) Turn the small **FMS** Knob to view the available transitions. Press the **ENT** Key to select the transition. The cursor moves to the Sequence box. The departure is previewed on the map.
- 7) Select the **INFO-x** Softkey to return to the Airport Information Page.

**REMOVING A DEPARTURE FROM THE ACTIVE FLIGHT PLAN**

When plans change while flying IFR, departures can be easily removed from the Active Flight Plan.

**Removing a departure procedure from the active flight plan:**

- 1) Press the **FPL** Key to display the Active Flight Plan Page (MFD) or the Active Flight Plan Window (PFD).
  - 2) Press the **MENU** Key, and highlight 'Remove Departure'.
  - 3) Press the **ENT** Key. A confirmation window is displayed listing the departure procedure.
  - 4) With 'OK' highlighted, press the **ENT** Key. To cancel the removal request, highlight 'CANCEL' and press the **ENT** Key.
- Or:**
- 1) Press the **FPL** Key to display the Active Flight Plan Page (MFD) or the Active Flight Plan Window (PFD).
  - 2) Press the **FMS** Knob, and turn to highlight the departure header in the active flight plan.
  - 3) Press the **CLR** Key. A confirmation window is displayed listing the departure procedure.
  - 4) With 'OK' highlighted, press the **ENT** Key. To cancel the removal request, highlight 'CANCEL' and press the **ENT** Key.
  - 5) Press the **FMS** Knob to remove the flashing cursor.



## ARRIVALS

A Standard Terminal Arrival (STAR) can be loaded at any airport that has one available. Only one arrival can be loaded at a time in a flight plan. If an arrival is loaded when another arrival is already in the active flight plan, the new arrival replaces the previous arrival. The route is defined by selection of an arrival, the transition waypoints, and a runway.

### LOADING AN ARRIVAL INTO THE ACTIVE FLIGHT PLAN

#### Loading an arrival into the active flight plan using the PROC Key:

- 1) Press the **PROC** Key. The Procedures Window is displayed.
- 2) Highlight 'SELECT ARRIVAL'.
- 3) Press the **ENT** Key. The Arrival Loading Page is displayed.
- 4) Use the **FMS** Knob to select an airport and press the **ENT** Key.
- 5) Select an arrival from the list and press the **ENT** Key.
- 6) Select a transition (if required) and press the **ENT** Key.
- 7) Select a runway (if required) and press the **ENT** Key. 'LOAD?' is highlighted.
- 8) Press the **ENT** Key to load the arrival procedure.

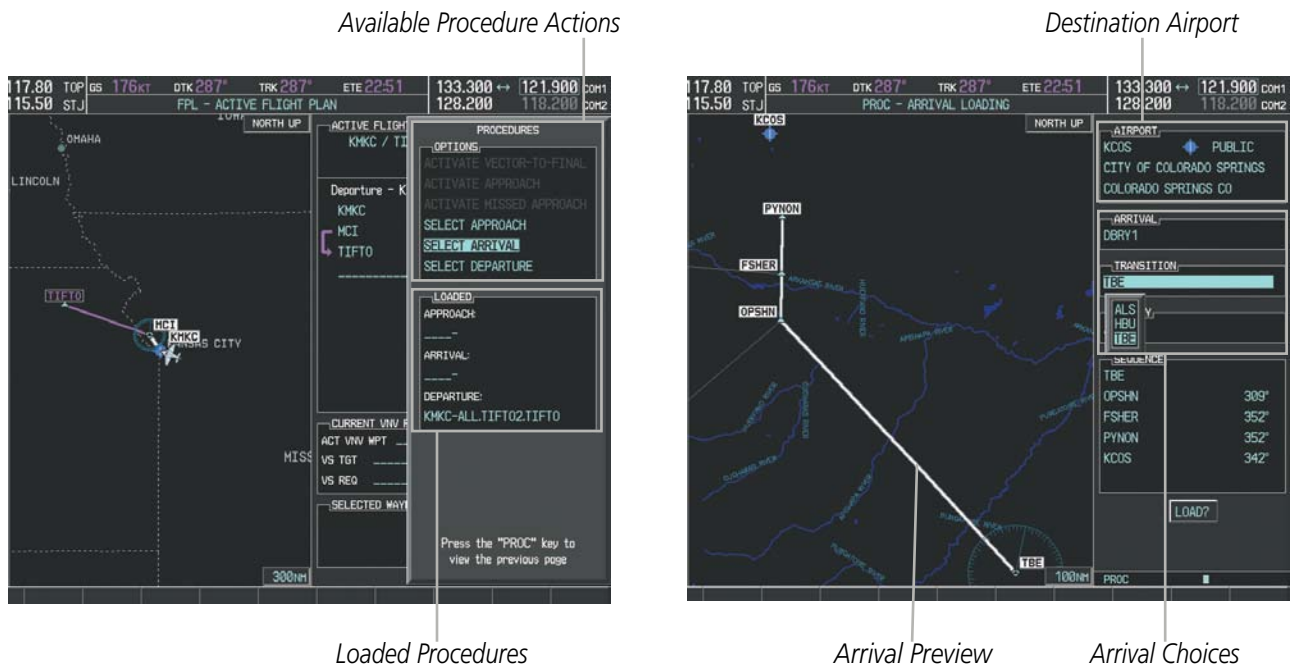

Figure 5-94 Arrival Selection

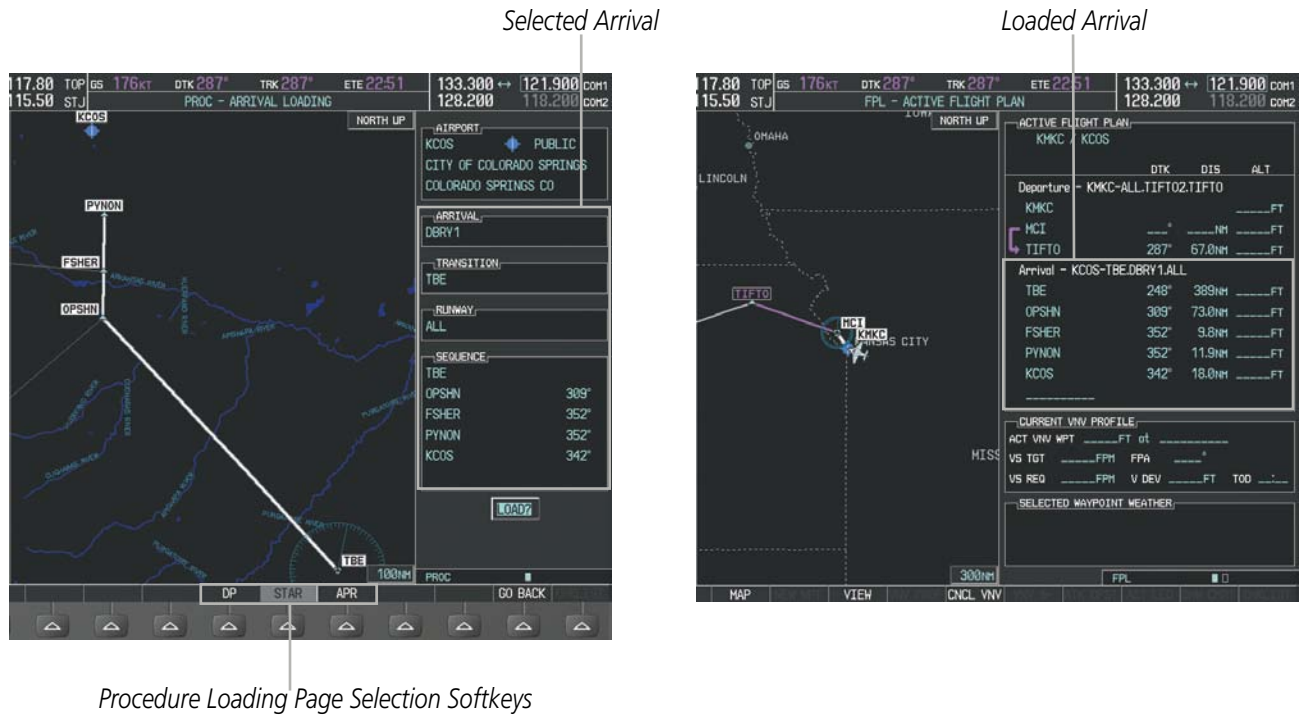

Figure 5-95 Arrival Loading

**Viewing available arrivals at an airport:**

- 1) From the Airport Information Page (first page in the WPT group), select the **STAR** Softkey. The Arrival Information Page is displayed, defaulting to the airport displayed on the Airport Information Page.
- 2) To select another airport, press the **FMS** Knob to activate the cursor, enter an identifier/facility name/city, and press the **ENT** Key.
- 3) Turn the large **FMS** Knob to highlight the Arrival. The arrival is previewed on the map.
- 4) Turn the small **FMS** Knob to view the available arrivals. Press the **ENT** Key to select the arrival. The cursor moves to the Transition box. The arrival is previewed on the map.
- 5) Turn the small **FMS** Knob to view the available transitions. Press the **ENT** Key to select the transition. The cursor moves to the Runway box. The arrival is previewed on the map.
- 6) Turn the small **FMS** Knob to view the available runways. Press the **ENT** Key to select the runway. The cursor moves to the Sequence box. The arrival is previewed on the map.
- 7) Select the **INFO-x** Softkey to return to the Airport Information Page.

## REMOVING AN ARRIVAL FROM THE ACTIVE FLIGHT PLAN

When plans change while flying IFR, arrivals can be easily removed from the Active Flight Plan.

### Removing an arrival from the active flight plan:

- 1) Press the **FPL** Key to display the Active Flight Plan Page (MFD) or the Active Flight Plan Window (PFD).
- 2) Press the **MENU** Key, and highlight 'Remove Arrival'.
- 3) Press the **ENT** Key. A confirmation window is displayed listing the arrival procedure.
- 4) With 'OK' highlighted, press the **ENT** Key. To cancel the removal request, highlight 'CANCEL' and press the **ENT** Key.

Or:

- 1) Press the **FPL** Key to display the Active Flight Plan Page (MFD) or the Active Flight Plan Window (PFD).
- 2) Press the **FMS** Knob, and turn to highlight the arrival header in the active flight plan.
- 3) Press the **CLR** Key. A confirmation window is displayed listing the arrival procedure.
- 4) With 'OK' highlighted, press the **ENT** Key. To cancel the removal request, highlight 'CANCEL' and press the **ENT** Key.
- 5) Press the **FMS** Knob to remove the flashing cursor.

## APPROACHES



**NOTE:** *If certain GPS parameters (SBAS, RAIM, etc.) are not available, some published approach procedures for the desired airport may not be displayed in the list of available approaches.*

An Approach Procedure (APPR) can be loaded at any airport that has one available, and provides guidance for non-precision and precision approaches to airports with published instrument approach procedures. Only one approach can be loaded at a time in a flight plan. If an approach is loaded when another approach is already in the active flight plan, the new approach replaces the previous approach. The route is defined by selection of an approach and the transition waypoints.

Whenever an approach is selected, the choice to either “load” or “activate” is given. “Loading” adds the approach to the end of the flight plan without immediately using it for navigation guidance. This allows continued navigation via the intermediate waypoints in the original flight plan, but keeps the procedure available on the Active Flight Plan Page for quick activation when needed. “Activating” also adds the procedure to the end of the flight plan but immediately begins to provide guidance to the first waypoint in the approach.

When selecting an approach, a “GPS” designation to the right of the procedure name indicates the procedure can be flown using the GPS receiver. Some procedures do not have this designation, meaning the GPS receiver can be used for supplemental navigation guidance only. If the GPS receiver cannot be used for primary guidance, the appropriate navigation receiver must be used for the selected approach (e.g., VOR or ILS). The final course segment of ILS approaches, for example, must be flown by tuning the NAV receiver to the proper frequency and selecting that NAV receiver on the CDI.

The G1000 SBAS GPS allows for flying LNAV, LNAV/VNAV, and LPV approaches according to the published chart. LNAV+V is a standard LNAV approach with advisory vertical guidance provided for assistance in maintaining a constant vertical glidepath similar to an ILS glideslope on approach. This guidance is displayed on the G1000 PFD in the same location as the ILS glideslope using a magenta diamond. In all cases where LNAV+V is indicated by the system during an approach, LNAV minima are used. The active approach type is annunciated on the HSI as shown in the following table:

HSI Annunciation	Description	Example on HSI
LNAV	GPS approach using published LNAV minima	 <p>Approach Type</p> <ul style="list-style-type: none"> <li>- LNAV</li> <li>- LNAV+V</li> <li>- L/VNAV</li> <li>- LPV</li> </ul>
LNAV+V	GPS approach using published LNAV minima. Advisory vertical guidance is provided	
L/VNAV	GPS approach using published LNAV/VNAV minima	
LPV	GPS approach using published LPV minima	

Table 5-9 Approach Types

### LOADING AN APPROACH INTO THE ACTIVE FLIGHT PLAN

#### Loading an approach into the active flight plan using the PROC Key:

- 1) Press the **PROC** Key. The Procedures Window is displayed.
- 2) Highlight 'SELECT APPROACH', and press the **ENT** Key. The Approach Loading Page is displayed.
- 3) Use the **FMS** Knob to select an airport and press the **ENT** Key.
- 4) Select an approach from the list and press the **ENT** Key.
- 5) Select a transition (if required) and press the **ENT** Key.
- 6) Barometric Minimums
  - a) To set 'MINIMUMS', turn the small **FMS** Knob to select 'BARO', and press the **ENT** Key. Turn the small **FMS** Knob to select the altitude, and press the **ENT** Key.
  - Or:
  - b) To skip setting minimums, press the **ENT** Key.
- 7) Press the **ENT** Key with 'LOAD?' highlighted to load the approach procedure; or turn the large **FMS** Knob to highlight 'ACTIVATE' and press the **ENT** Key to load and activate the approach procedure.



**NOTE:** When GPS is not approved for the selected final approach course, the message 'NOT APPROVED FOR GPS' is displayed. GPS provides guidance to the approach, but the HSI must be switched to a NAV receiver to fly the final course of the approach.

SYSTEM OVERVIEW  
 FLIGHT INSTRUMENTS  
 EIS  
 AUDIO PANEL & CNS  
 FLIGHT MANAGEMENT  
 HAZARD AVOIDANCE  
 AFCS  
 ADDITIONAL FEATURES  
 APPENDICES  
 INDEX



Figure 5-96 Approach Selection



Procedure Loading Page Selection Softkeys LOAD OR ACTIVATE? Annunciation

Figure 5-97 Approach Loading

**Viewing available approaches at an airport:**

- 1) From the Airport Information Page (first page in the WPT group), select the **APR** Softkey. The Approach Information Page is displayed, defaulting to the airport displayed on the Airport information Page.
- 2) To select another airport, press the **FMS** Knob to activate the cursor, enter an identifier/facility name/city, and press the **ENT** Key.



- 3) Press the **FMS** Knob, then turn the large **FMS** Knob to highlight the Approach. The approach is previewed on the map.
- 4) Turn the small **FMS** Knob to view the available approaches. Press the **ENT** Key to select the approach. The cursor moves to the Transition box. The approach is previewed on the map.
- 5) Turn the small **FMS** Knob to view the available transitions. Press the **ENT** Key to select the transition. The cursor moves to the Minimums box. The approach is previewed on the map.
- 6) Turn the small **FMS** Knob to select BARO minimums on or off. Press the **ENT** Key.
  - a) When minimums are selected on, the cursor moves to the minimum altitude field. Use the small FMS Knob to select the altitude. Press the **ENT** Key. The cursor moves to the Sequence box. The approach is previewed on the map.  
**Or:**
  - b) When minimums are selected off, the cursor moves to the Sequence box. The approach is previewed on the map.
- 7) Press the INFO-x Softkey to return to the Airport Information Page.

### Loading an approach into the active flight plan from the Nearest Airport Page:

- 1) Select the Nearest Airports Page.
- 2) Press the **FMS** Knob, then turn the large **FMS** Knob to highlight the desired nearest airport. The airport is previewed on the map.
- 3) Press the **APR** Softkey; or press the **MENU** Key, highlight 'Select Approach Window', and press the **ENT** Key.
- 4) Turn the **FMS** Knob to highlight the desired approach.
- 5) Press the **LD APR** Softkey; or press the **MENU** Key, highlight 'Load Approach', and press the **ENT** Key. The Approach Loading Page is displayed with the transitions field highlighted.
- 6) Turn the **FMS** Knob to highlight the desired transition, and press the **ENT** Key.
- 7) Barometric Minimums
  - a) To set 'MINIMUMS', turn the small **FMS** Knob to select 'BARO', and press the **ENT** Key. Turn the small **FMS** Knob to select the altitude, and press the **ENT** Key. The 'LOAD?' field is highlighted.  
**Or:**
  - b) To skip setting minimums, press the **ENT** Key. The 'LOAD?' field is highlighted.
- 8) Press the **ENT** Key with 'LOAD?' highlighted to load the approach procedure; or turn the large **FMS** Knob to highlight 'ACTIVATE' and press the **ENT** Key to load and activate the approach procedure. The system continues navigating the current flight plan until the approach is activated. When GPS is not approved for the selected final approach course, the message 'NOT APPROVED FOR GPS' is displayed. GPS provides guidance to the approach, but the HSI must be switched to a NAV receiver to fly the final course of the approach.

## ACTIVATING AN APPROACH

A previously loaded approach can be activated from the Procedures Window.

### Activating a previously loaded approach:

- 1) Press the **PROC** Key. The Procedures Window is displayed with 'Activate Approach' highlighted.
- 2) Press the **ENT** Key to activate the approach.

In many cases, it may be easiest to “load” the full approach while still some distance away, enroute to the destination airport. Later, if vectored to final, use the steps above to select 'Activate Vector-To-Final' — which makes the inbound course to the FAF waypoint active.

### Activating a previously loaded approach with vectors to final:

- 1) Press the **PROC** Key to display the Procedures Window.
- 2) Highlight 'ACTIVATE VECTOR-TO-FINAL' and press the **ENT** Key.

### Loading and activating an approach using the MENU Key:

- 1) From the Approach Loading Page, press the **MENU** Key. The page menu is displayed with 'Load & Activate Approach' highlighted.
- 2) Press the **ENT** Key. When GPS is not approved for the selected final approach course, the message 'NOT APPROVED FOR GPS' is displayed. GPS provides guidance to the approach, but the HSI must to be switched to a NAV receiver to fly the final course of the approach.

## REMOVING AN APPROACH FROM THE ACTIVE FLIGHT PLAN

When plans change while flying IFR, approaches can be easily removed from the Active Flight Plan.

### Removing an approach from the active flight plan:

- 1) Press the **FPL** Key to display the Active Flight Plan Page (MFD) or the Active Flight Plan Window (PFD).
- 2) Press the **MENU** Key, and highlight 'Remove Approach'.
- 3) Press the **ENT** Key. A confirmation window is displayed listing the approach procedure.
- 4) With 'OK' highlighted, press the **ENT** Key. To cancel the removal, highlight 'CANCEL' and press the **ENT** Key.

Or:

- 1) Press the **FPL** Key to display the Active Flight Plan Page (MFD) or the Active Flight Plan Window (PFD).
- 2) Press the **FMS** Knob, and turn to highlight the approach header in the active flight plan.
- 3) Press the **CLR** Key. A confirmation window is displayed listing the approach procedure.
- 4) With 'OK' highlighted, press the **ENT** Key. To cancel the removal, highlight 'CANCEL' and press the **ENT** Key.
- 5) Press the **FMS** Knob to remove the flashing cursor.



## MISSED APPROACH

### Activating a missed approach in the active flight plan:

Press the Go Around Button.

Or:

Fly past the MAP, and press the **SUSP** Softkey on the PFD.

Or:

- 1) Press the **PROC** Key.
- 2) Turn the **FMS** Knob to highlight 'ACTIVATE MISSED APPROACH'.
- 3) Press the **ENT** Key. The aircraft automatically sequences to the MAHP.

## COURSE TO ALTITUDE

In this missed approach procedure, the altitude immediately following the MAP (in this case '6368ft') is not part of the published procedure. It is simply a Course to Altitude (CA) leg which guides the aircraft along the runway centerline until the altitude required to safely make the first turn toward the MAHP is exceeded. This altitude is provided by Jeppesen, and may be below, equal to, or above the published minimums for this approach. In this case, if the aircraft altitude is below the specified altitude (6,368 feet) after crossing the MAP, a direct-to is established to provide a course on runway heading until an altitude of 6,368 feet is reached. After reaching 6,368 feet, a direct-to is established to the published MAHP (in this case MOGAL). If the aircraft altitude is above the specified altitude after crossing the MAP, a direct-to is established to the published fix (MOGAL) to begin the missed approach procedure.

In some missed approach procedures this Course to Altitude leg may be part of the published procedure. For example, a procedure may dictate a climb to 5,500 feet, then turn left and proceed to the Missed Approach Hold Point (MAHP). In this case, the altitude would appear in the list of waypoints as '5500ft'. Again, if the aircraft altitude is lower than the prescribed altitude, a direct-to is established on a Course to Altitude leg when the missed approach procedure is activated.

ACTIVE FLIGHT PLAN			
KMKC / KCOS			
	DTK	DIS	ALT
FSHER	352°	9.8NM	9500FT
PYNON	352°	11.9NM	9500FT
Approach - KCOS-RNAV 35Rgps LPV			
HABUK iaf	021°	5.9NM	9000FT
FALUR	261°	5.0NM	8600FT
CEGIX faf	351°	6.0NM	7800FT
RW35R map	351°	5.1NM	
6368FT	348°	0.4NM	6370FT
MOGAL mahp			10000FT
HOLD	168°	6.0NM	

Figure 5-98 Course to Altitude

## 5.9 TRIP PLANNING

The G1000 allows the pilot to view trip planning information, fuel information, and other information for a specified flight plan or flight plan leg based on automatic data, or based on manually entered data. Weight planning is also available, based on manually entered fuel data and the active flight plan (to estimate remaining fuel).

### TRIP PLANNING

All of the input of data needed for calculation and viewing of the statistics is done on the Trip Planning Page located in the AUX Page Group.

*Selected Flight Plan Segment*  
 - FPL Number/Cumulative Legs (CUM or REM) or Leg Number (NN)  
 - Waypoints Defining Selected Flight Plan/Flight Plan Leg

**Preview of Selected Flight Plan/Flight Plan Leg**

**Trip Statistics**  
 Desired Track -  
 Distance -  
 Est. Time Enroute -  
 Est. Time of Arrival -  
 Enroute Safe Altitude -  
 Sunrise Time (local) -  
 Sunset Time (local) -

**Fuel Statistics**  
 Efficiency -  
 Total Endurance -  
 Remaining Fuel -  
 Remaining Endurance -  
 Fuel Required -  
 Total Range -

**Trip Planning Page Mode**  
 - Automatic/Manual

**Trip Input Data (sensor/pilot)**  
 - Departure Time (local)  
 - Ground Speed  
 - Fuel Flow  
 - Fuel On Board Aircraft  
 - Calibrated Airspeed  
 - Indicated Altitude  
 - Barometric Pressure  
 - Total Air Temperature

**Other Statistics**  
 - Density Altitude  
 - True Airspeed (TAS)

**Softkeys**  
 - Automatic/Manual Page Mode  
 - Flight Plan/Waypoint Mode

Figure 5-99 Trip Planning Page

The trip planning inputs are based on sensor inputs (automatic page mode) or on pilot inputs (manual page mode). Some additional explanation of the sources for some of the inputs is as follows:

- Departure time (DEP TIME) - This defaults to the current time in automatic page mode. The computations are from the aircraft present position, so the aircraft is always just departing.
- Calibrated airspeed (CALIBRATED AS) - The primary source is from the air data system, and the secondary source of information is GPS ground speed.
- Indicated altitude (IND ALTITUDE) - The primary source is the barometric altitude, and the secondary source of information is GPS altitude.

## TRIP STATISTICS

The trip statistics are calculated based on the selected starting and ending waypoints and the trip planning inputs.

In flight plan mode (FPL) with a stored flight plan selected (NN), and the entire flight plan (CUM) selected, the waypoints are the starting and ending waypoints of the selected flight plan.

In flight plan mode (FPL) with a stored flight plan selected (NN), and a specific leg (NN) selected, the waypoints are the endpoints of the selected leg.

In flight plan mode (FPL) with the active flight plan selected (00), and the remaining flight plan (REM) selected, the 'from' waypoint is the present position of the aircraft and the 'to' waypoint is the endpoint of the active flight plan.

In flight plan mode (FPL) with the active flight plan selected (00), and a specific leg (NN) selected, the 'from' waypoint is the current aircraft position and the 'to' waypoint is the endpoint of the selected leg.

In waypoint (WPTS) mode these are manually selected waypoints (if there is an active flight plan, these default to the endpoints of the active leg).

Some of the calculated trip statistics are dashed when the selected leg of the active flight plan has already been flown.

- Desired Track (DTK) - DTK is shown as nnn° and is the desired track between the selected waypoints. It is dashed unless only a single leg is selected.
- Distance (DIS) - The distance is shown in tenths of units up to 99.9, and in whole units up to 9999.
- Estimated time enroute (ETE) - ETE is shown as hours:minutes until less than an hour, then it is shown as minutes:seconds.
- Estimated time of arrival (ETA) - ETA is shown as hours:minutes and is the local time at the destination.
  - If in waypoint mode then the ETA is the ETE added to the departure time.
  - If a flight plan other than the active flight plan is selected it shows the ETA by adding to the departure time all of the ETEs of the legs up to and including the selected leg. If the entire flight plan is selected, then the ETA is calculated as if the last leg of the flight plan was selected.
  - If the active flight plan is selected the ETA reflects the current position of the aircraft and the current leg being flown. The ETA is calculated by adding to the current time the ETEs of the current leg up to and including the selected leg. If the entire flight plan is selected, then the ETA is calculated as if the last leg of the flight plan was selected.
- Enroute safe altitude (ESA) - The ESA is shown as nnnnnFT
- Destination sunrise and sunset times (SUNRISE, SUNSET) - These times are shown as hours:minutes and are the local time at the destination.

## FUEL STATISTICS

The fuel statistics are calculated based on the selected starting and ending waypoints and the trip planning inputs. Some of the calculated trip statistics are dashed when the selected leg of the active flight plan has already been flown.

- Fuel efficiency (EFFICIENCY) - This value is calculated by dividing the current ground speed by the current fuel flow.
- Time of fuel endurance (TOTAL ENDUR) - This time is shown as hours:minutes. This value is obtained by dividing the amount of fuel on board by the current fuel flow.
- Fuel on board upon reaching end of selected leg (REM FUEL) - This value is calculated by taking the amount of fuel onboard and subtracting the fuel required to reach the end of the selected leg.
- Fuel endurance remaining at end of selected leg (REM ENDUR) - This value is calculated by taking the time of fuel endurance and subtracting the estimated time enroute to the end of the selected leg.
- Fuel required for trip (FUEL REQ) - This value is calculated by multiplying the time to go by the fuel flow.
- Total range at entered fuel flow (TOTAL RANGE) - This value is calculated by multiplying the time of fuel endurance by the ground speed.

## OTHER STATISTICS

These statistics are calculated based on the system sensor inputs or the manual trip planning inputs.

- Density altitude (DENSITY ALT)
- True airspeed (TRUE AIRSPEED)

The pilot may select automatic (AUTO) or manual (MANUAL) page mode, and flight plan (FPL) or waypoint (WPTS) mode. In automatic page mode, only the FPL, LEG, or waypoint IDs are editable (based on FPL/WPTS selection).

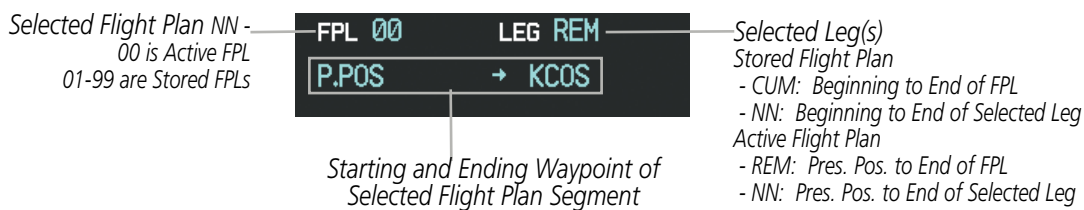

Figure 5-100 Trip Planning Page - Flight Plan Mode

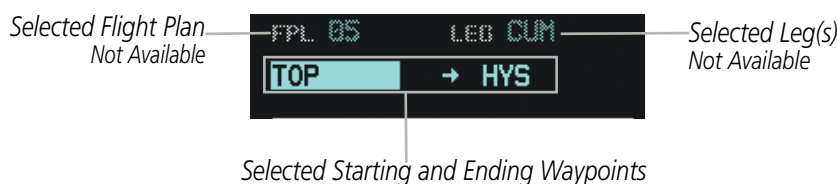

Figure 5-101 Trip Planning Page - Waypoint Mode

**Selecting automatic or manual page mode:**

Select the **AUTO** Softkey or the **MANUAL** Softkey; or press the **MENU** Key, highlight 'Auto Mode' or 'Manual Mode', and press the **ENT** Key.

**Selecting flight plan or waypoint mode:**

Select the **FPL** Softkey or the **WPTS** Softkey; or press the **MENU** Key, highlight 'Flight Plan Mode' or 'Waypoints Mode', and press the **ENT** Key.

**Selecting a flight plan and leg for trip statistics:**

- 1) Press the **FMS** Knob to activate the cursor in the flight plan number field.
- 2) Turn the small **FMS** Knob to select the desired flight plan number.
- 3) Turn the large **FMS** Knob to highlight 'CUM' or 'REM'. The statistics for each leg can be viewed by turning the small **FMS** Knob to select the desired leg. The Inset Map also displays the selected data.

**Selecting waypoints for waypoint mode:**

- 1) Select the **WPTS** Softkey; or press the **MENU** Key, highlight 'Waypoints Mode', and press the **ENT** Key. The cursor is positioned in the waypoint field directly below the FPL field.
- 2) Turn the **FMS** knobs to select the desired waypoint (or select from the Page Menu 'Set WPT to Present Position' if that is what is desired), and press the **ENT** Key. The cursor moves to the second waypoint field.
- 3) Turn the **FMS** knobs to select the desired waypoint, and press the **ENT** Key. The statistics for the selected leg are displayed.

In manual page mode, the other eight trip input data fields must be entered by the pilot, in addition to flight plan and leg selection.

**Entering manual data for trip statistics calculations:**

- 1) Select the **MANUAL** Softkey or select 'Manual Mode' from the Page Menu, and press the **ENT** Key. The cursor may now be positioned in any field in the top right two boxes.
- 2) Turn the **FMS** Knobs to move the cursor onto the DEP TIME field and enter the desired value. Press the **ENT** Key. The statistics are calculated using the new value and the cursor moves to the next entry field. Repeat until all desired values have been entered.

## 5.10 RAIM PREDICTION

RAIM (Receiver Autonomous Integrity Monitoring) is a GPS receiver function that performs a consistency check on all tracked satellites. RAIM ensures that the available satellite geometry allows the receiver to calculate a position within a specified RAIM protection limit (2.0 nm for oceanic, 2.0 nm for enroute, 1.0 nm for terminal, and 0.3 nm for non-precision approaches). During oceanic, enroute, and terminal phases of flight, RAIM is available nearly 100% of the time. The RAIM prediction function also indicates whether RAIM is available at a specified date and time. RAIM computations predict satellite coverage within  $\pm 15$  min of the specified arrival date and time. Because of the tighter protection limit on approaches, there may be times when RAIM is not available. RAIM prediction must be initiated manually if there is concern over SBAS coverage at the destination or some other reason that compromises navigation precision. If RAIM is not predicted to be available for the final approach course, the approach does not become active. If RAIM is not available when crossing the FAF, the missed approach procedure must be flown.

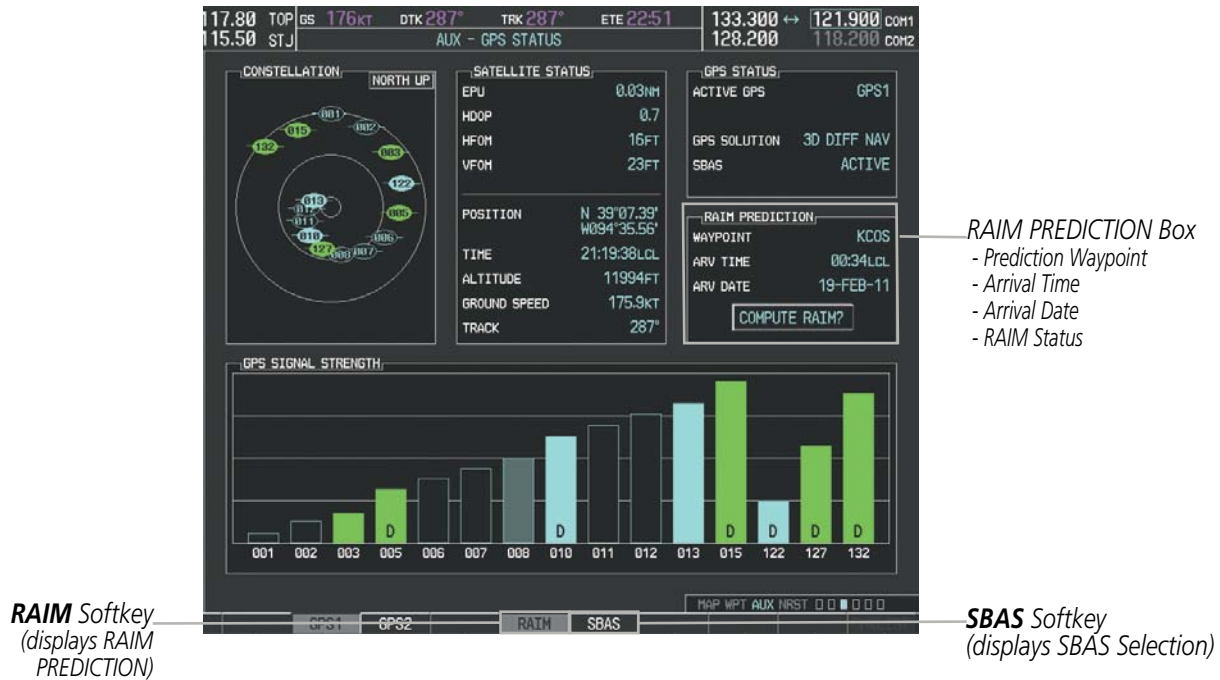

Figure 5-102 RAIM Prediction

**Predicting RAIM availability at a selected waypoint:**

- 1) Select the AUX-GPS Status Page.
- 2) Press the **FMS** Knob. The RAIM Prediction 'WAYPOINT' field is highlighted.
- 3) Turn the small **FMS** Knob to display the Waypoint Information Window. (Turning it clockwise displays a blank Waypoint Information Window, turning it counter-clockwise displays the Waypoint Information Window with a waypoint selection submenu allowing selection of active flight plan, nearest, recent, user, or airway waypoints).
- 4) Enter the identifier, facility, or city name of the departure waypoint; or select a waypoint from the submenu of waypoints and press the **ENT** Key to accept the waypoint entry.
- 5) Turn the FMS Knobs to enter an arrival time and press the **ENT** Key.
- 6) Turn the FMS Knobs to enter an arrival date and press the **ENT** Key.
- 7) Press the **ENT** Key with 'COMPUTE RAIM?' highlighted to begin the computation.

**Predicting RAIM availability at the aircraft present position:**

- 1) Select the AUX-GPS Status Page.
- 2) Press the **FMS** Knob. The RAIM Prediction 'WAYPOINT' field is highlighted.
- 3) Press the **MENU** Key, highlight 'Set WPT to Present Position', and press the **ENT** Key.
- 4) Press the **ENT** Key to accept the waypoint entry.
- 5) Turn the FMS Knobs to enter an arrival time and press the **ENT** Key.
- 6) Turn the FMS Knobs to enter an arrival date and press the **ENT** Key.
- 7) Press the **ENT** Key with 'COMPUTE RAIM?' highlighted to begin the computation.

Status of the RAIM computation for the selected waypoint, time, and date is displayed at the bottom of the RAIM PREDICTION Box as follows:

- 'COMPUTE RAIM?' - RAIM has not been computed.
- 'COMPUTING AVAILABILITY' - RAIM calculation is in progress.
- 'RAIM AVAILABLE' - RAIM is predicted to be available.
- 'RAIM NOT AVAILABLE' - RAIM is predicted to be unavailable.

The Satellite Based Augmentation System (SBAS) provides increased navigation accuracy when available. SBAS can be enabled or disabled manually on the GPS Status Page.



- SYSTEM OVERVIEW
- FLIGHT INSTRUMENTS
- EIS
- AUDIO PANEL & CNS
- FLIGHT MANAGEMENT
- HAZARD AVOIDANCE
- AFCS
- ADDITIONAL FEATURES
- APPENDICES
- INDEX



Figure 5-103 SBAS Display - Active

**Enabling/Disabling SBAS:**

- 1) Select the AUX-GPS Status Page.
- 2) Press the **SBAS** Softkey.
- 3) Press the **FMS** Knob, and turn the large FMS Knob to highlight 'EGNOS', 'MSAS' or 'WAAS'.
- 4) Press the **ENT** Key to disable SBAS. Press the **ENT** Key again to enable SBAS.



Figure 5-104 SBAS Display - Disabled

## 5.11 NAVIGATING A FLIGHT PLAN

The following discussion is an example of navigating a flight plan with the SBAS capable GPS system while the G1000 provides vertical guidance through descents. A lateral flight plan (LNAV) would be navigated in much the same way, but would not include vertical guidance when the final approach course is active.



**NOTE:** The following example flight plan is for instructional purposes only. All database information depicted should be considered not current.

The example is a flight plan from KMKC to KCOS filed using the TIFTO2 departure, various Victor Airways, and the DBRY1 arrival with the transition at TBE. The flight plan includes an enroute altitude of 12,000 feet, an LPV (WAAS) approach selected for runway 35R, and a missed approach executed at the Missed Approach Point (MAP). A few enroute changes are demonstrated.

- 1) Prior to departure, the TIFTO2 departure, the airways, and the DBRY1 arrival at KCOS are loaded. See the Procedures section for loading departures and arrivals. Note the magenta arrow in Figure 5-105 indicating the active departure leg.

After takeoff, ATC assigns a heading of 240°.

- 2) Figure 5-105 shows the aircraft on the assigned heading of 240°. 'TERM' (Terminal) is the current CDI flight phase displayed on the HSI indicating 1.0 nm CDI scaling.

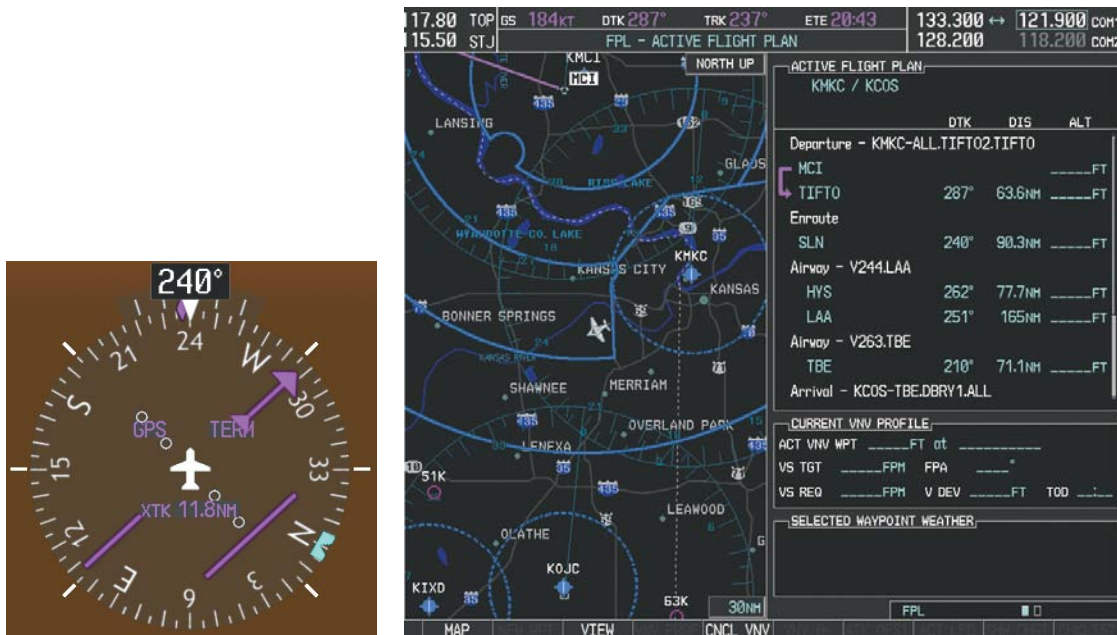

Figure 5-105 Assigned Heading of 240°

- 3) ATC now assigns routing to join V4. A heading of 290° is assigned to intercept V4. The aircraft turns to heading 290° as seen in Figure 5-106.

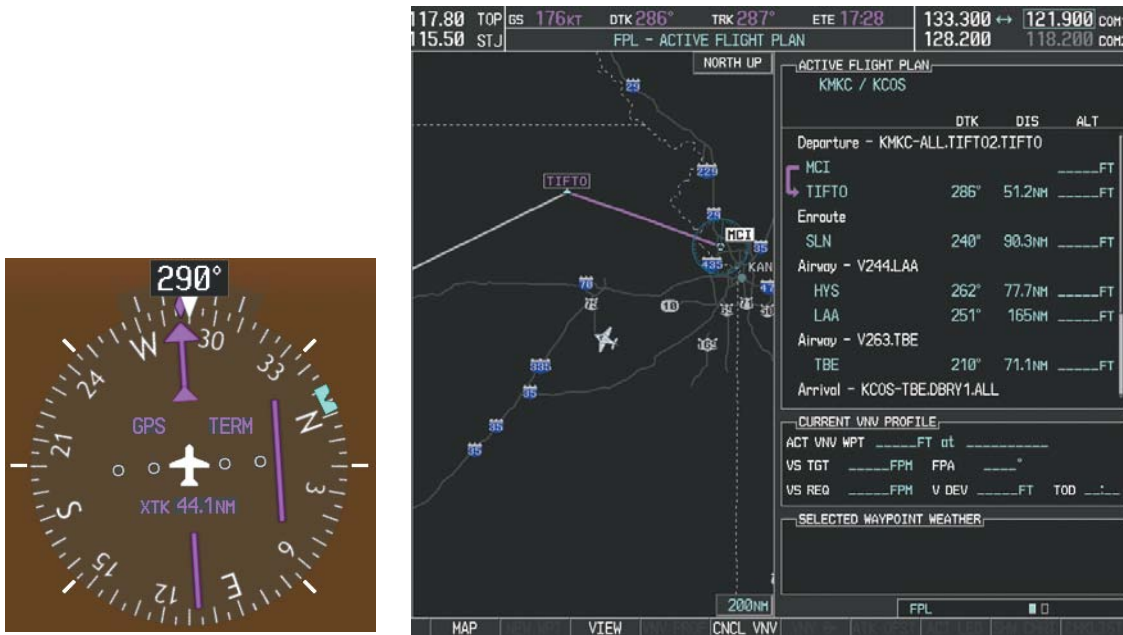

Figure 5-106 Assigned Heading of 290°

- 4) Enter V4 into the flight plan.
  - a) Press the **FMS** Knob to activate the cursor.

- b) The desired entry point for V4 (TOP) must be entered. Turn the large **FMS** Knob to highlight the desired flight plan insertion point (SLN) as shown in Figure 5-107. When the V4 entry point (TOP) is inserted, it is placed immediately above the highlighted waypoint (SLN).

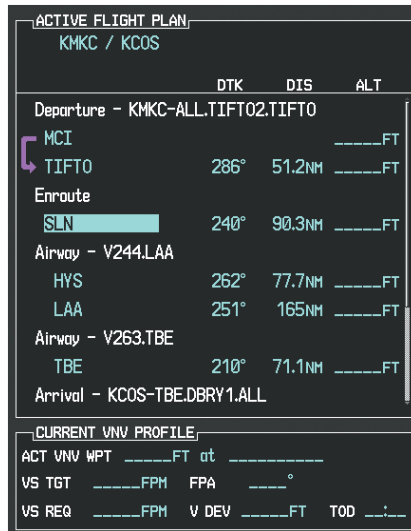

Figure 5-107 Begin Adding V4 to the Flight Plan

- c) Turn the small **FMS** Knob to display the Waypoint Information Window. Enter the desired entry point for V4, Topeka VOR (TOP), as shown in Figure 5-108.



Figure 5-108 Entering V4 Entry Point

d) Press the **ENT** Key. TOP is inserted into the flight plan as in Figure 5-109.

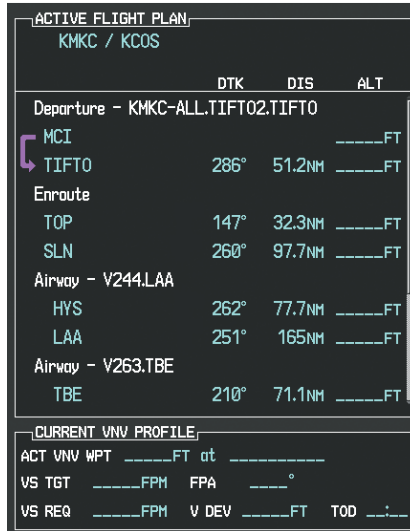

Figure 5-109 TOP Inserted into the Flight Plan

e) With SLN still highlighted as in Figure 5-108, turn the small **FMS** Knob clockwise. The Waypoint Information Page is displayed and the **LD AIRWY** Softkey is now available.

f) Select the **LD AIRWY** Softkey to display the list of available airways for TOP as seen in Figure 5-110.



Figure 5-110 List of Available Airways for TOP

g) Turn either **FMS** Knob to highlight V4 in the list as seen in Figure 5-110.

h) Press the **ENT** Key. The list of available exits for V4 is now displayed as in Figure 5-111.



Figure 5-111 List of Available Exits for V4

- i) If necessary, turn either **FMS** Knob to select the desired exit. In this case Salina VOR (SLN) is selected as in Figure 5-111.
- j) Press the **ENT** Key. The selected airway and exit are displayed, and the prompt “LOAD?” highlighted as in Figure 5-112.



Figure 5-112 Ready to Load V4

k) Press the **ENT** Key.

l) V4 is now loaded into the flight plan as shown in Figure 5-113.

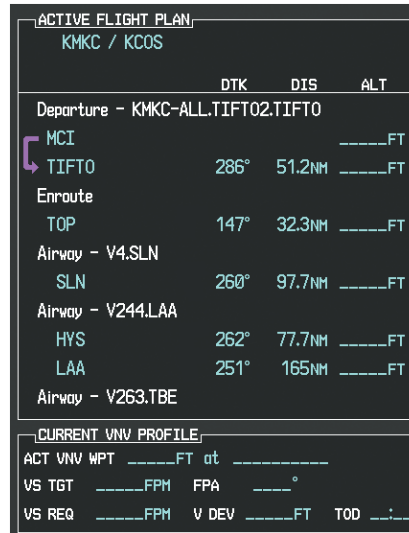

Figure 5-113 V4 is Loaded in the Flight Plan

- 5) Making V4 the active leg of the flight plan.
  - a) Press the **FMS** Knob to activate the cursor.
  - b) Turn the large **FMS** Knob to highlight SLN. The TO waypoint of the leg is selected in order to activate the leg.
  - c) Select the **ACT LEG** Softkey. The confirmation window is now displayed as in Figure 5-114. Note the TOP to SLN leg is actually part of V4.



Figure 5-114 Confirm Active Leg



- d) Verify the displayed leg is the desired leg and press the **ENT** Key. Note in Figure 5-115, the magenta arrow in the flight plan window and magenta line on the map indicating V4 is now the active flight plan leg. Note the phase of flight remained in Terminal (TERM) mode up to this point because a departure leg was active. Since a leg after the departure is now active, the current CDI flight phase is ENR (Enroute) and CDI scaling has changed to 2.0 nm.

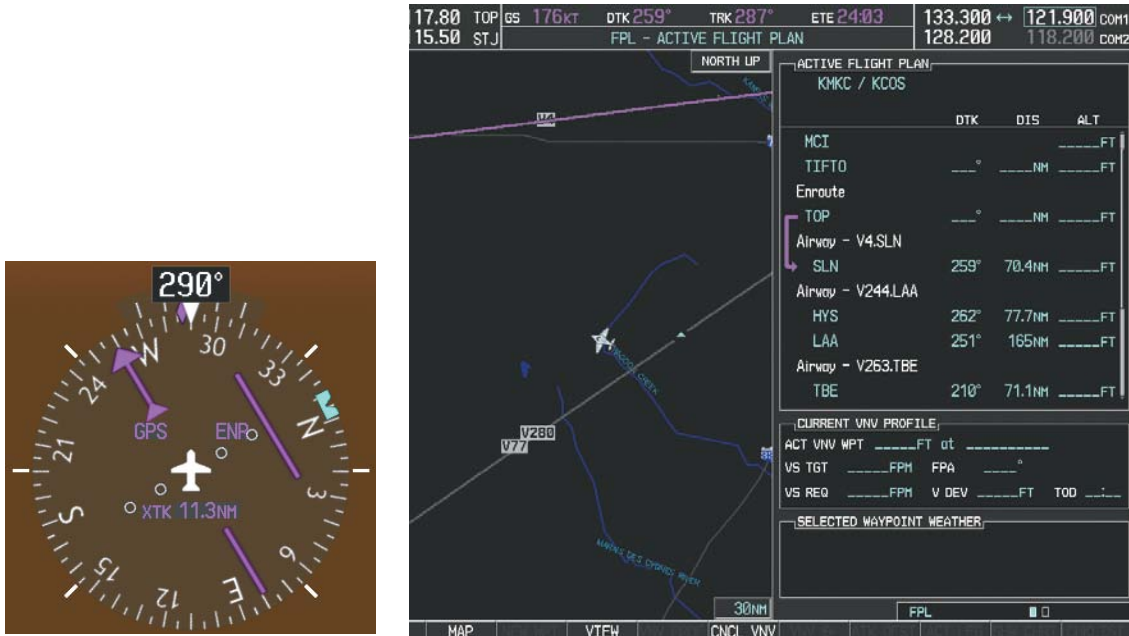

Figure 5-115 V4 Now Active Leg

- 6) The aircraft continues on heading 290°. When crosstrack distance is less than 2.0 nm, the XTK disappears from the HSI and the CDI is positioned on the last dot indicating a 2.0 nm distance from the centerline of the next course.

7) As the CDI approaches center, the aircraft turns onto the active leg as seen in Figure 5-116.

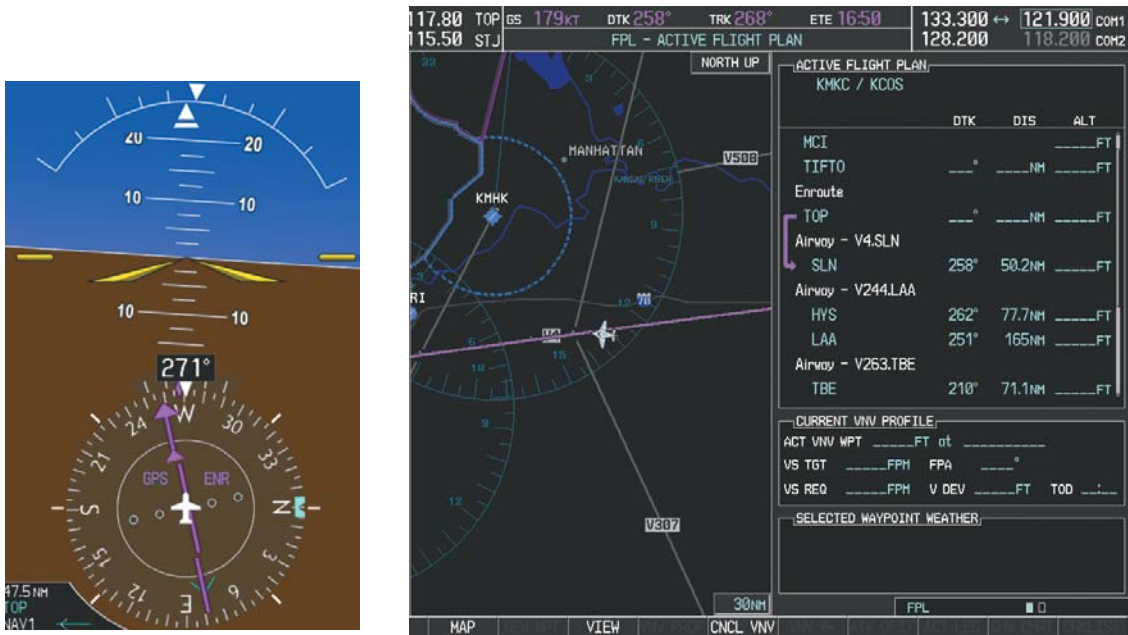

Figure 5-116 Turn on to Active Leg

8) At SLN, Victor Airway 244 (V244) is intercepted. Turn prompts are displayed in the PFD Navigation Status Box as seen in Figure 5-117.

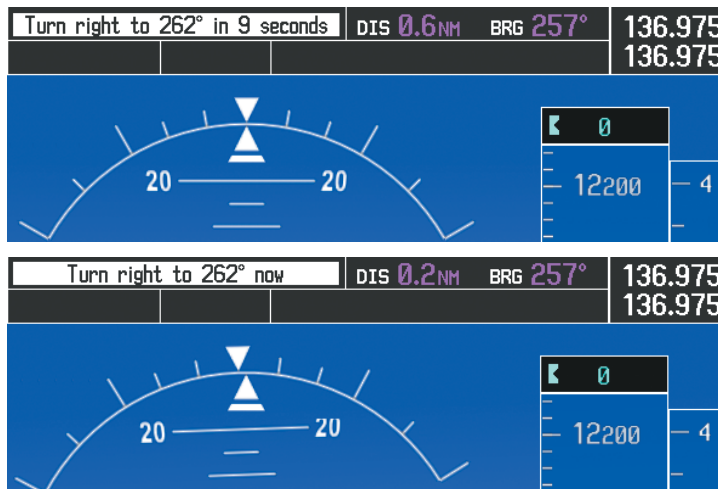

Figure 5-117 Turn to Intercept V244

9) As seen in Figure 5-118, V244 is now the active flight plan leg.



Figure 5-118 V244 Now Active Leg

SYSTEM OVERVIEW

FLIGHT INSTRUMENTS

EIS

AUDIO PANEL & CNS

FLIGHT MANAGEMENT

HAZARD AVOIDANCE

AFCS

ADDITIONAL FEATURES

APPENDICES

INDEX

10) At Lamar VOR (LAA) V263 is intercepted. See Figure 5-119.

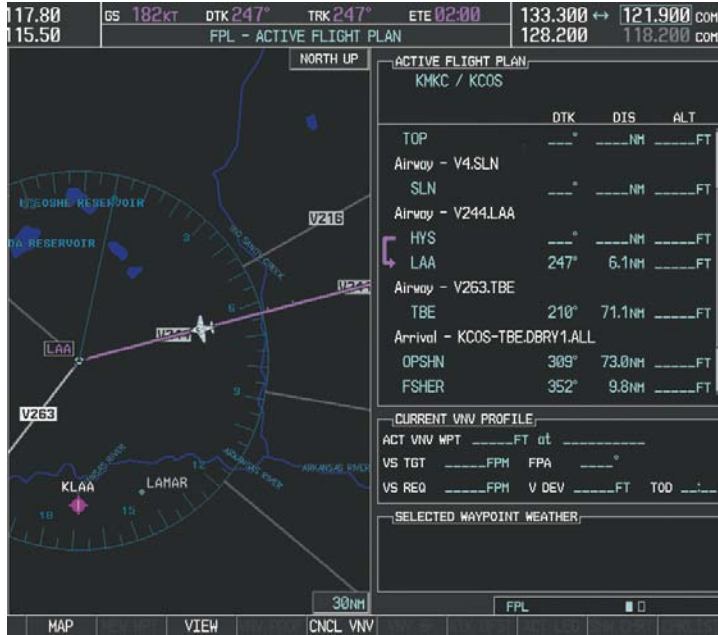

Figure 5-119 HYS to LAA Leg Active

11) ATC grants clearance to proceed direct to the OPSHN intersection to begin the arrival procedure. ATC advises to expect an altitude of 10,000 feet at OPSHN.

- a) Press the **FMS** Knob to activate the cursor.
- b) Turn the large **FMS** Knob to select OPSHN in the flight plan list.
- c) Press the **Direct-to** (D➤) Key. The Direct-to Window is now displayed as shown in Figure 5-120.



Figure 5-120 Direct To OPSHN

d) Turn the large **FMS** Knob to place the cursor in the VNV altitude field as shown in Figure 5-121.



Figure 5-121 Enter VNV Altitude

e) An altitude of 10,000 feet is entered as requested by ATC.

f) Press the **ENT** Key. The cursor is now displayed in the VNV offset field as shown in Figure 5-122.



Figure 5-122 Enter VNV Offset Distance

g) Enter the offset, or distance from the waypoint at which to reach the selected altitude. In this case, three miles prior to OPSHN is entered. In other words, the G1000 gives vertical guidance so the aircraft arrives at an altitude of 10,000 feet three miles prior to OPSHN.

h) Press the **ENT** Key twice to activate the direct-to. Note, in Figure 5-123, the magenta arrow indicating the direct-to OPSHN after the offset waypoint for OPSHN. The preceding offset waypoint indicates the offset distance and altitude that were previously entered. The remaining waypoints in the loaded arrival procedure have no database specified altitudes, therefore, dashes are displayed. Keep the CDI centered and maintain a track along the magenta line to OPSHN.

Note the Direct-to waypoint is within the loaded arrival procedure, therefore, phase of flight scaling for the CDI changes to Terminal Mode and is annunciated by displaying 'TERM' on the HSI.



**NOTE:** If the loaded arrival procedure has waypoints with altitude constraints retrieved from the database to be used as is, the altitude must be manually accepted by placing the cursor over the desired altitude, then pressing the ENT Key. The altitude is now displayed as light blue meaning it is used by the system to determine vertical speed and deviation guidance.



Figure 5-123 Direct-to Active

12) The aircraft is proceeding to OPSHN. The expected approach is the RNAV LPV approach to runway 35R, so it is selected.

a) Press the **PROC** Key to display the Procedures Window.

b) 'SELECT APPROACH' should be highlighted as shown in Figure 5-124.

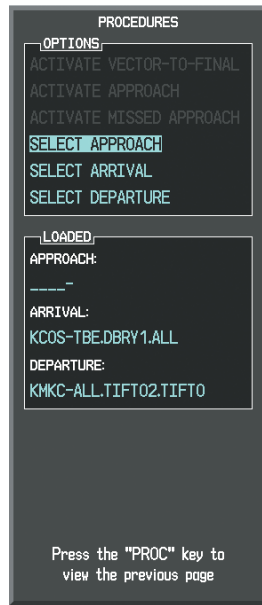

Figure 5-124 Procedures Window

c) Press the **ENT** Key. A list of available approaches for the destination airport is displayed as in Figure 5-125.



Figure 5-125 List of Available Approaches

d) Turn either **FMS** Knob to select the LPV approach for 35R as shown in Figure 5-125.



e) Press the **ENT** Key. A list of available transitions for the selected approach is displayed as in Figure 5-126.



Figure 5-126 List of Available Transitions

f) Turn either **FMS** Knob to select the desired transition. In this case, the Initial Approach Fix (IAF) at HABUK is used.

g) Press the **ENT** Key.

h) Barometric Minimums

To set 'MINIMUMS', turn the small **FMS** Knob to select 'BARO', and press the **ENT** Key. Turn the small **FMS** Knob to select the altitude, and press the **ENT** Key.

Or:

To skip setting minimums, press the **ENT** Key.

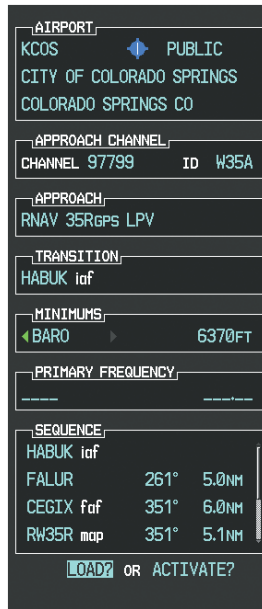

Figure 5-127 Barometric Minimums Set

- i) With 'LOAD?' highlighted, again press the ENT Key. The selected approach is added to the flight plan as seen in Figure 5-128.



Figure 5-128 Loaded Approach

- 13) Note the altitude constraints associated with each of the approach waypoints as seen in Figure 5-129. These altitudes are loaded from the database and are displayed as light blue text, indicating these values are “designated” for use in computing vertical deviation guidance.

Note: To no longer use the displayed altitude for calculating vertical deviation guidance, perform the following:

- a) Press the **FMS** Knob to activate the cursor.
- b) Turn the small **FMS** Knob to highlight the desired altitude.
- c) Press the **CLR** Key.
- d) Press the **FMS** Knob to deactivate the cursor.

After making the altitude “non-designated”, it is displayed as white text.

Altitude constraint values associated with the Final Approach Fix (FAF) and waypoints beyond the FAF cannot be designated for vertical guidance. These altitude values are always displayed as white text, as in Figure 5-129. Vertical guidance from the FAF and on to the Missed Approach Point (MAP) is given using the WAAS GPS altitude source, therefore, the displayed altitude values are for reference only.

ACTIVE FLIGHT PLAN			
KMKC / KCOS			
	DTK	DIS	ALT
FSHER	352°	9.8NM	10000FT
PYNON	352°	11.9NM	10000FT
Approach - KCOS-RNAV 35R GPS LPV			
HABUK iaf	021°	5.9NM	9000FT
FALUR	261°	5.0NM	8600FT
DEGIX faf	351°	6.0NM	7800FT
RW35R map	351°	5.1NM	
6368FT	348°	0.4NM	6370FT
MOGAL mahp			10000FT
HOLD	168°	6.0NM	
-----			
CURRENT VNV PROFILE			
ACTIVE VNV WPT	10000FT at OPSHN -3NM		
VS TGT	-796FPM	FPA	-3.0°
VS REQ	_____FPM	TIME TO TOD	29:49
V DEV	_____FT		

Figure 5-129 Vertical Guidance is Active to the FAF

- 14) As the aircraft approaches OPSHN, it may be desirable to adjust the speed, or steepness of the upcoming descent. The default Flight Path Angle (FPA) is -3.0 degrees and a required vertical speed is computed to maintain the -3.0 FPA. To change the vertical flight path, perform the following steps.
  - a) Select the **VNV PROF** Softkey to place the cursor in the target vertical speed field (VS TGT) as shown in Figure 5-130.
  - b) At this point, the descent vertical speed can be selected, or the FPA can be selected. Turn the large **FMS** Knob to select the desired selection field, then turn the small **FMS** Knob to enter the desired value.

Note the information now displayed in the 'CURRENT VNV PROFILE' box. Also, note the offset waypoint (orange box) and gray circle are now displayed on the map. The gray circle marks the Top of Descent (TOD). In this example, vertical guidance is provided at the TOD that results in a -3.0 degree FPA descent to an altitude of 10,000 feet upon reaching the offset waypoint.

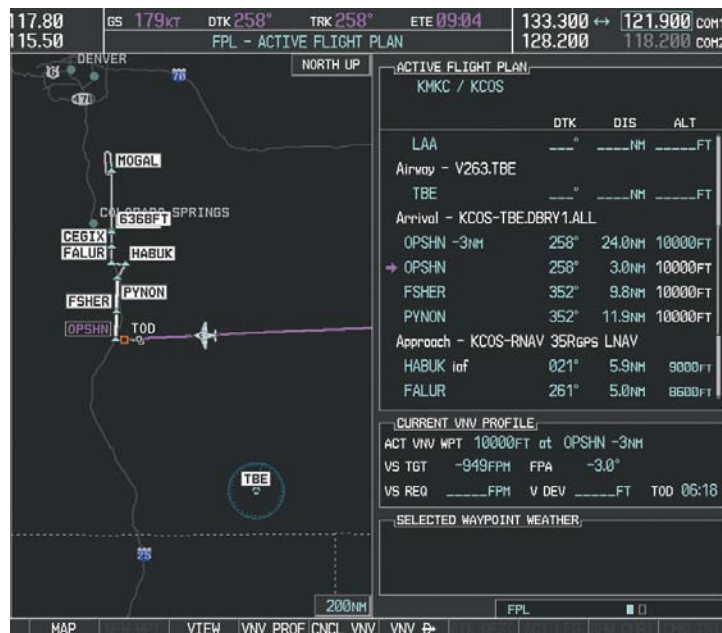

Figure 5-130 Adjusting the Descent

- c) Press the **ENT** Key.

- 15) As seen in Figure 5-131, the aircraft is approaching TOD. Note the target vertical speed required to reach the selected altitude. The Vertical Deviation Indicator (VDI) and the Required Vertical Speed Indicator (RVSI) are now displayed on the PFD as shown in Figure 5-132. When the aircraft is within one minute of the TOD, it is annunciated as shown in Figure 5-132, and an aural alert 'Vertical track' will be heard.



Figure 5-131 Approaching Top of Descent (TOD)

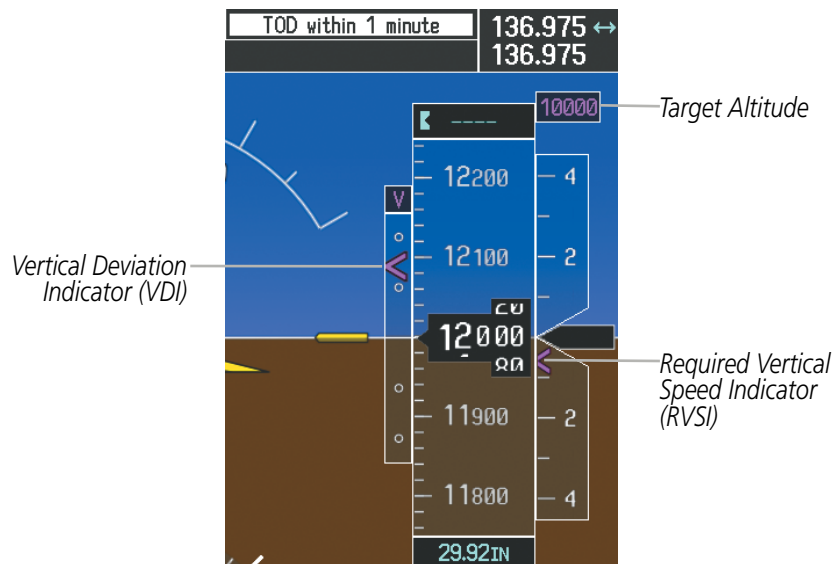

Figure 5-132 VDI & RVSI Upon Reaching Top of Descent (TOD)

- 16) Upon reaching TOD, a descent vertical speed is established by placing the VSI pointer in line with the RVSI as shown in Figure 5-133.

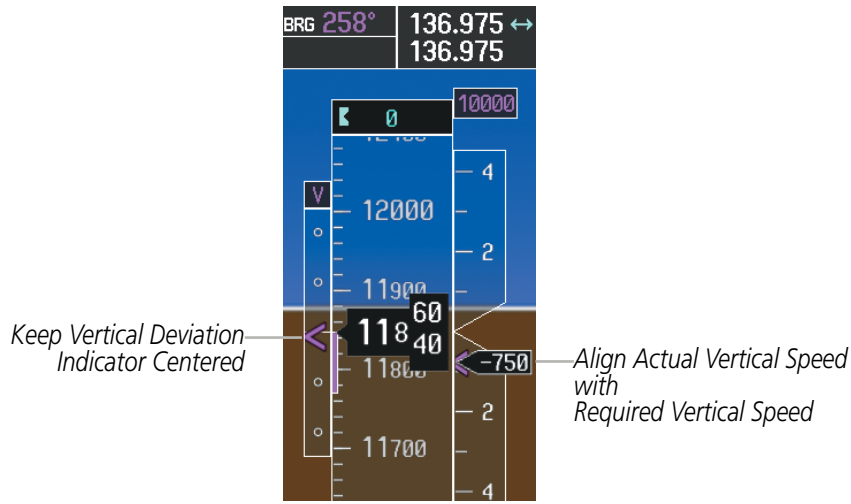

Figure 5-133 VDI & RVSI Showing Correctly Established Descent

- 17) When the aircraft is one minute from the bottom of descent (BOD) it is annunciated as shown in Figure 5-134. Upon reaching the offset waypoint for OPSHN, the aircraft is at 10,000 feet.

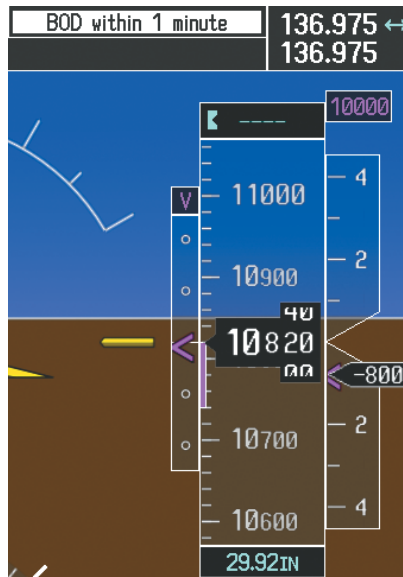

Figure 5-134 Approaching Bottom of Descent (BOD) at OPSHN Offset Waypoint

- 18) The aircraft is approaching OPSHN. The upcoming turn and next heading are announced at the top left of the PFD as seen in Figure 5-135. Initiate the turn and maneuver the aircraft on a track through the turn radius to intercept the magenta line for the OPSHN to FSHER leg and center the CDI.

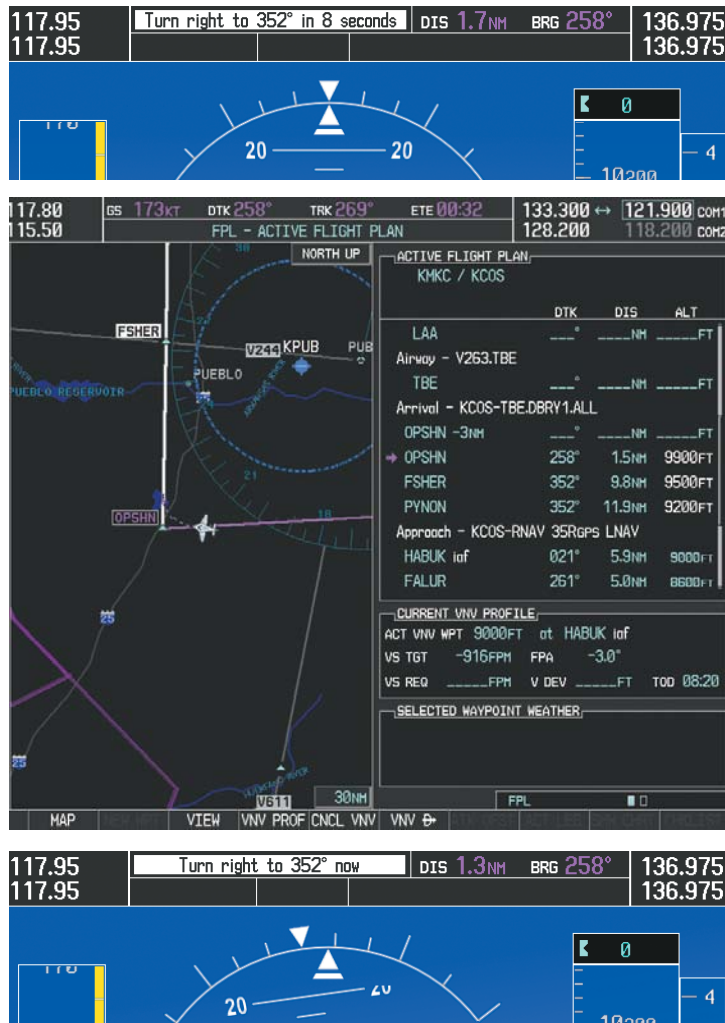

Figure 5-135 Turn to intercept OPSHN to FSHER Leg



- 19) After passing OPSHN, the next leg of the arrival turns magenta as shown in Figure 5-136. The magenta arrow in the flight plan list now indicates the OPSHN to FSHER leg of the arrival procedure is now active.



Figure 5-136 Tracking the OPSHN to FSHER Leg

- 20) The flight continues through the arrival procedure to PYNON (see Figure 5-137). At a point 31 nm from the destination airport, the phase of flight scaling for the CDI changes to Terminal Mode and is annunciated by displaying 'TERM' on the HSI.

A descent to HABUK is in the next leg. Note the TOD point on the map. Annunciations for the upcoming turn and descent, as well as the VDI and RVSI, appear on the PFD as the flight progresses.

- SYSTEM OVERVIEW
- FLIGHT INSTRUMENTS
- EIS
- AUDIO PANEL & CNS
- FLIGHT MANAGEMENT
- HAZARD AVOIDANCE
- AFCS
- ADDITIONAL FEATURES
- APPENDICES
- INDEX



Figure 5-137 Approaching PYNON

- 21) Upon passing PYNON the approach procedure automatically becomes active. The approach may be activated at any point to proceed directly to the IAF. In this example, the aircraft has progressed through the final waypoint of the arrival and the flight plan has automatically sequenced to the IAF as the active leg, activating the approach procedure (see Figure 5-138).



Figure 5-138 Approach is Now Active

Note: To manually activate the approach procedure, perform the following steps:

- Press the **PROC** Key.
- Turn the large **FMS** Knob to highlight 'ACTIVATE APPROACH' as shown in Figure 5-139.
- Press the **ENT** Key to activate the approach.

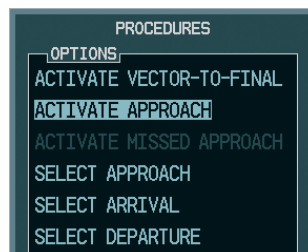

Figure 5-139 Manually Activate Approach

- 22) The IAF is the next waypoint. At the TOD, establish a descent vertical speed as previously discussed in Step 16. The aircraft altitude is 9,000 feet upon reaching HABUK.



Figure 5-140 Descending Turn to the Initial Approach Fix (IAF)

- 23) After crossing FALUR the next waypoint is the FAF. The flight phase changes to LPV on the HSI indicating the current phase of flight is in Approach Mode and the approach type is LPV. CDI scaling changes accordingly and is used much like a localizer when flying an ILS approach. The RVSI is no longer displayed and the VDI changes to the Glidepath Indicator (as shown in Figure 5-141) when the final approach course becomes active.

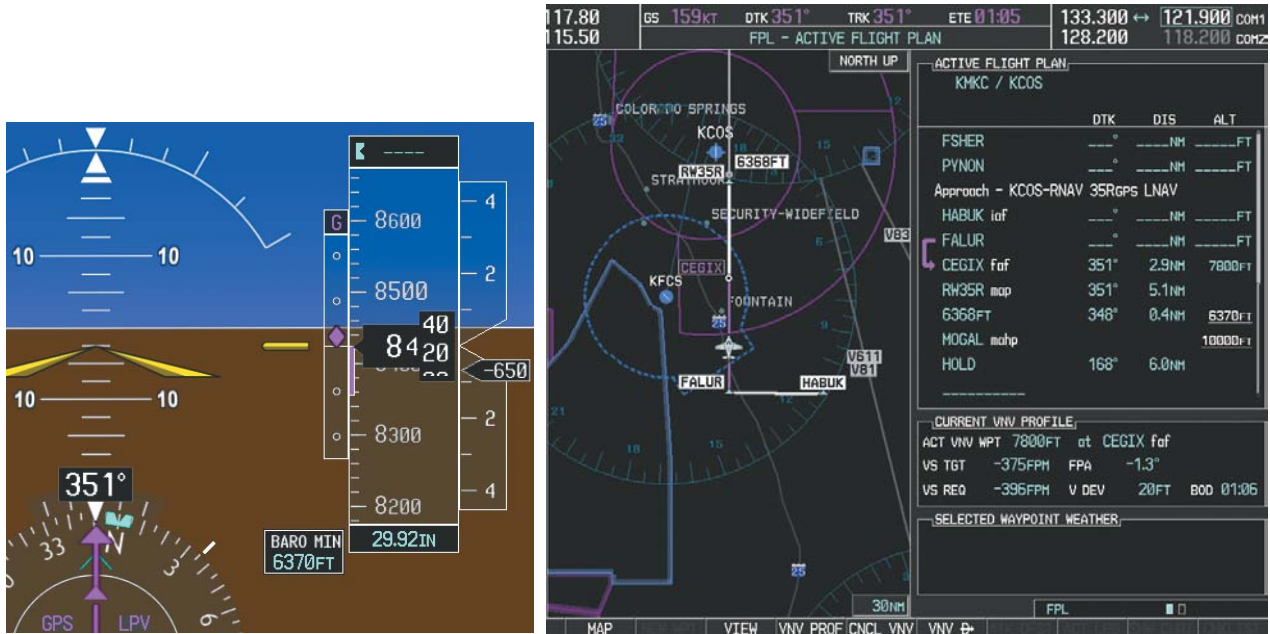

Figure 5-141 Descending to the FAF

The descent continues through the FAF (CEGIX) using the Glidepath Indicator, as one would use a glideslope indicator, to obtain an altitude "AT" 7,800 feet at the FAF. Note the altitude restriction lines over and under (At) the altitude in the 'ALT' field in Figure 5-141.



- 24) After crossing CEGIX, the aircraft continues following the glidepath to maintain the descent to “AT or ABOVE” 6,370 feet at the Missed Approach Point (MAP) (RW35R) as seen in Figure 5-142.



Figure 5-142 Descending to the Missed Approach Point

In this missed approach procedure, the altitude immediately following the MAP (in this case '6368ft') is not part of the published procedure. It is simply a Course to Altitude (CA) leg which guides the aircraft along the runway centerline until the altitude required to safely make the first turn toward the MAHP is exceeded. This altitude is provided by Jeppesen, and may be below, equal to, or above the published minimums for this approach. In this case, if the aircraft altitude is below the specified altitude (6,368 feet) after crossing the MAP, a direct-to is established to provide a course on runway heading until an altitude of 6,368 feet is reached. After reaching 6,368 feet, a direct-to is established to the published MAHP (in this case MOGAL). If the aircraft altitude is above the specified altitude after crossing the MAP, a direct-to is established to the published fix (MOGAL) to begin the missed approach procedure.

In some missed approach procedures this Course to Altitude leg may be part of the published procedure. For example, a procedure may dictate a climb to 5,500 feet, then turn left and proceed to the Missed Approach Hold Point (MAHP). In this case, the altitude would appear in the list of waypoints as '5500ft'. Again, if the aircraft altitude is lower than the prescribed altitude, a direct-to is established on a Course to Altitude leg when the missed approach procedure is activated.

- 25) Upon reaching the MAP, it is decided to execute a missed approach. Automatic waypoint sequencing is suspended past the MAP. Press the Go Around Button, or press the **SUSP** Softkey on the PFD, to resume automatic waypoint sequencing through the missed approach procedure.

A direct-to is initiated to MOGAL, which is the Missed Approach Hold Point (MAHP) as seen in Figure 5-143. The aircraft is climbing to 10,000 feet. The CDI flight phase now changes from LPV to MAPR as seen on the HSI.

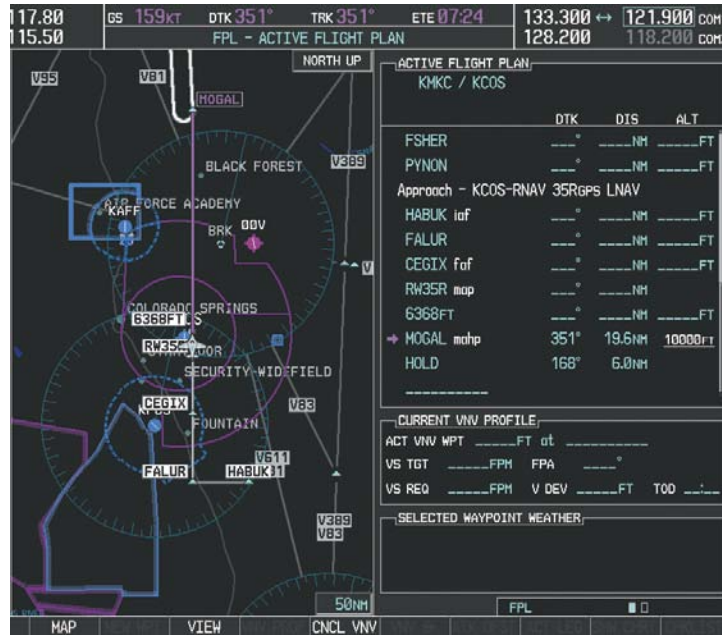

Figure 5-143 Missed Approach Active





## 5.12 ABNORMAL OPERATION

This section discusses the Dead Reckoning mode of operation and the subsequent indications.



**NOTE:** *Dead Reckoning Mode only functions in Enroute (ENR) or Oceanic (OCN) phase of flight. In all other phases, an invalid GPS solution produces a “NO GPS POSITION” annunciation on the map and the G1000 stops using GPS.*

While in Enroute or Oceanic phase of flight, if the G1000 detects an invalid GPS solution or is unable to calculate a GPS position, the system automatically reverts to Dead Reckoning (DR) Mode. In DR Mode, the G1000 uses its last-known position combined with continuously updated airspeed and heading data (when available) to calculate and display the aircraft's current estimated position.

It is important to note that estimated navigation data supplied by the G1000 in DR Mode may become increasingly unreliable and must not be used as a sole means of navigation. If while in DR Mode airspeed and/or heading data is also lost or not available, the DR function may not be capable of accurately tracking estimated position and, consequently, the system may display a path that is different than the actual movement of the aircraft. Estimated position information displayed by the G1000 through DR while there is no heading and/or airspeed data available should not be used for navigation.

DR Mode is inherently less accurate than the standard GPS/SBAS Mode due to the lack of satellite measurements needed to determine a position. Changes in wind speed and/or wind direction compounds the relative inaccuracy of DR Mode. Because of this degraded accuracy, other navigation equipment must be relied upon for position awareness until GPS-derived position data is restored.

DR Mode is indicated on the G1000 by the appearance of the letters 'DR' superimposed in yellow over the 'own aircraft' symbol as shown in Figure 5-146. In addition, 'DR' is prominently displayed in yellow on the HSI slightly above and to the right of the aircraft symbol on the CDI as shown in Figure 5-146. Also, the CDI deviation bar is removed from the display. Lastly, but at the same time, a 'GPS NAV LOST' alert message appears on the PFD. Normal navigation using GPS/SBAS source data resumes automatically once a valid GPS solution is restored.

As a result of operating in DR Mode, all GPS-derived data is computed based upon an estimated position and is displayed as yellow text on the display to denote degraded navigation source information as shown in Figure 5-146.

Also, while the G1000 is in DR Mode, the autopilot does not couple to GPS, and both TAWS and Terrain Proximity are disabled. Additionally, the accuracy of all nearest information (airports, airspaces, and waypoints) is questionable. Finally, airspace alerts continue to function, but with degraded accuracy.

- SYSTEM OVERVIEW
- FLIGHT INSTRUMENTS
- EIS
- AUDIO PANEL & CNS
- FLIGHT MANAGEMENT
- HAZARD AVOIDANCE
- AFCS
- ADDITIONAL FEATURES
- APPENDICES
- INDEX

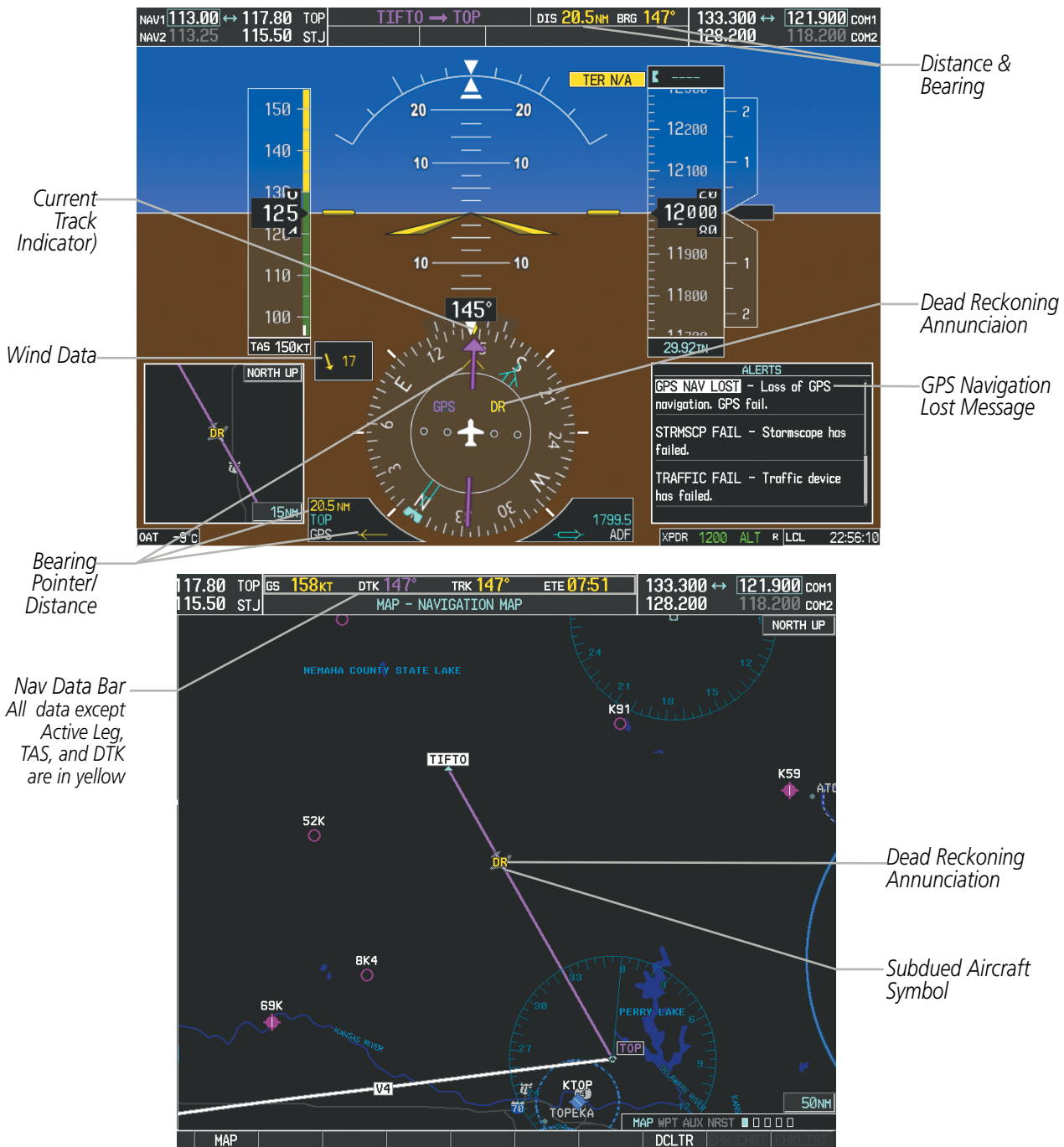

Figure 5-146 Dead Reckoning Mode - GPS Derived Data Shown in Yellow



**NOTE:** The Inset Map is removed from the PFD any time aircraft pitch is greater than +30° or less than -20°, or when a 65° bank angle is reached.

## SECTION 6 HAZARD AVOIDANCE

Hazard avoidance features available for the G1000 are designed to aid situational awareness and provide advisory information with regard to potential hazards to flight safety associated with weather, terrain, and air traffic.

### Weather

- GDL 69/69A XM WX Satellite Weather and Temporary Flight Restrictions (Optional)
- L-3 Stormscope® WX-500 Series II Weather Mapping Sensor (Optional)

### Terrain Avoidance

- Terrain Proximity
- Terrain-SVS (Included with SVS option)

### Traffic

- Traffic Information Service (TIS)
- Avidyne TAS600® Traffic Advisory System (TAS) (Optional)

## 6.1 XM WX SATELLITE WEATHER



**NOTE:** XM WX Satellite Weather data provides information for avoiding hazardous weather. It is not to be used to penetrate hazardous weather conditions.

XM WX Satellite Weather is a service provided through the GDL 69/69A, a remote-mounted datalink satellite receiver. Received graphical weather information and associated text is displayed on the Multi Function Display (MFD) and the Primary Flight Display (PFD) Inset Map. The GDL 69A can also receive SiriusXM Satellite Radio entertainment services. Both weather data and entertainment programming operate in the S-band frequency range to provide continuous reception capabilities at any altitude throughout North America.

Both services from SiriusXM are subscription-based. For more information on specific service packages, visit [www.siriusxm.com](http://www.siriusxm.com).

### ACTIVATING SERVICES

Before XM WX Satellite Weather and SiriusXM Satellite Radio can be used, the services must be activated. Service is activated by providing coded IDs unique to the installed GDL 69/69A. SiriusXM Satellite Radio (audio) and XM WX Satellite Weather (data) services each have coded IDs. The Data and Audio Radio IDs must be provided to activate the weather service and entertainment subscriptions, respectively. These IDs are located on:

- The label on the back of the Data Link Receiver
- The XM Information Page on the MFD (Figure 6-1)
- The XM Satellite Radio Activation Instructions included with the unit (available at [www.garmin.com](http://www.garmin.com), P/N 190-00355-04)

Contact the installer if the Audio and Data Radio IDs cannot be located.

SiriusXM uses the coded IDs to send an activation signal that allows the system to display weather data and/or entertainment programming provided through the GDL 69/69A.

#### Activating XM WX Satellite Weather and SiriusXM Satellite Radio services:

- 1) Contact SiriusXM by the customer service phone number listed on their website. Follow the instructions provided by SiriusXM customer service.
- 2) Select the XM Page in the Auxiliary Page Group.
- 3) Press the **INFO** Softkey to display the XM Information Page.
- 4) Verify that the desired services are activated.
- 5) Press the **LOCK** Softkey.
- 6) Turn the large **FMS** Knob to highlight 'YES'.
- 7) To complete activation, press the **ENT** Key.



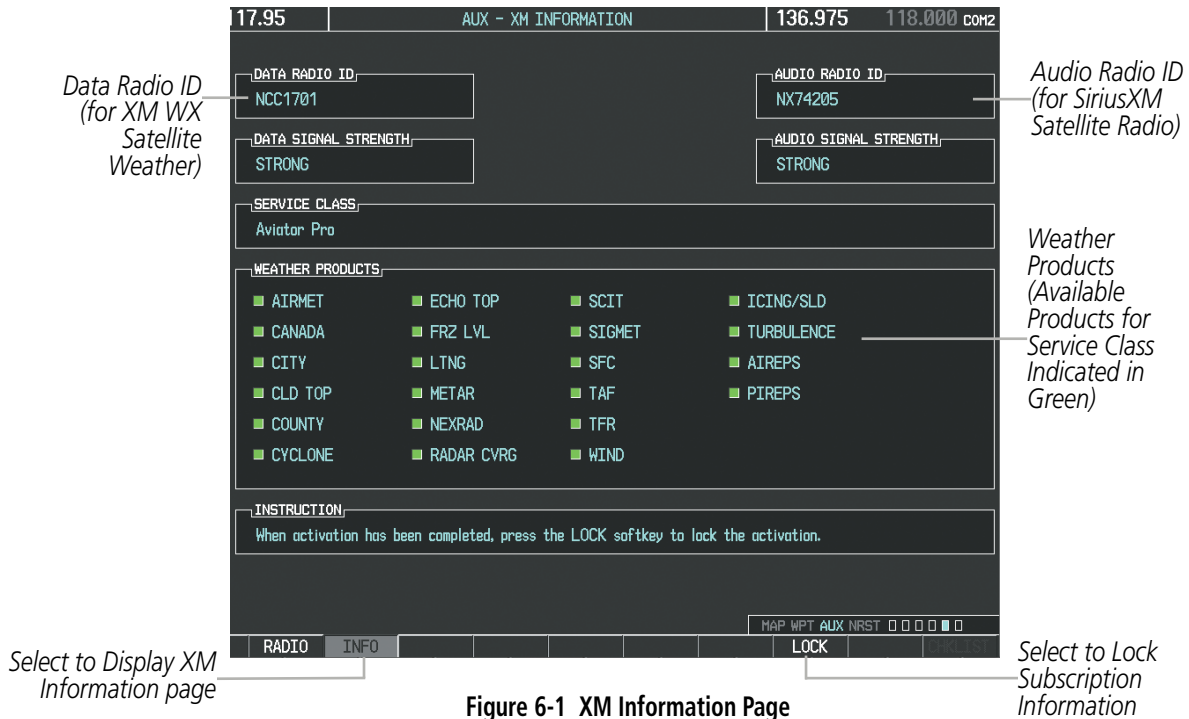

Figure 6-1 XM Information Page

## USING XM WX SATELLITE WEATHER PRODUCTS

The principal map for viewing XM WX data is the Map - XM Weather Data Link Page. This is the only map display capable of showing information for all available XM WX products.

### Viewing the XM Weather Data Link Page:

- 1) Turn the large **FMS** Knob to select the Map Page Group.
- 2) Turn the small **FMS** Knob to select the XM Weather Data Link Page.

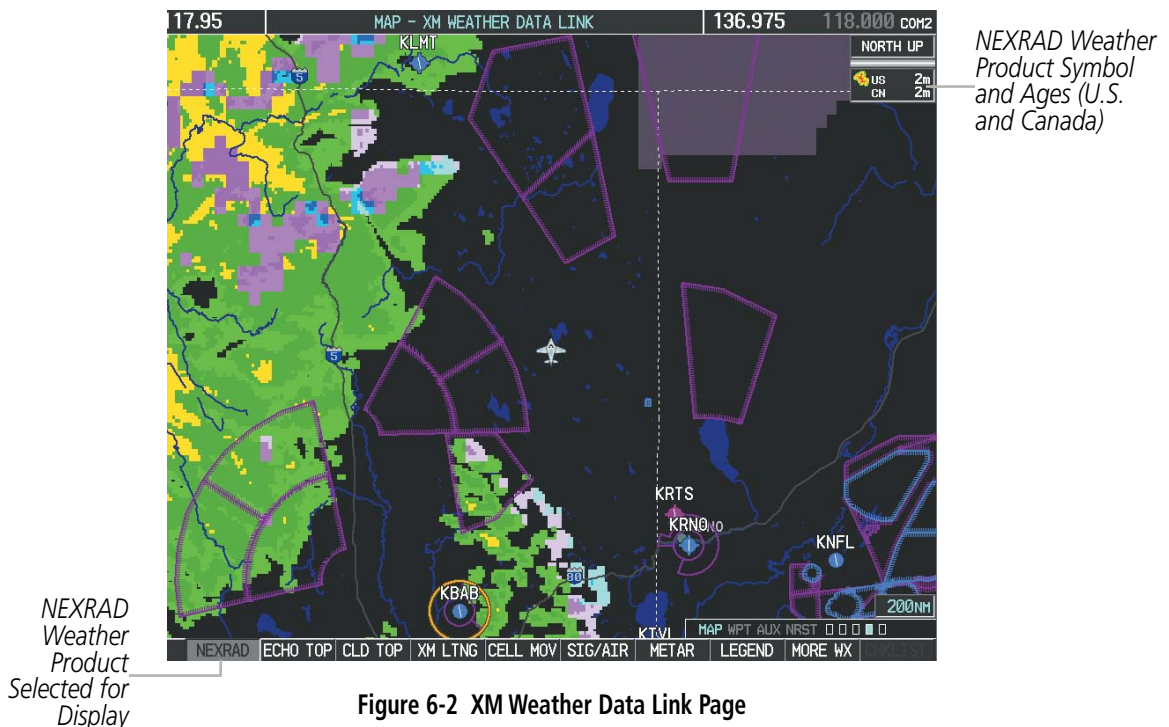

Figure 6-2 XM Weather Data Link Page

When an XM WX product is active on a MFD map, the age of the data is displayed on the screen to the right of the product symbol (Figure 6-2). The age of the product is based on the time difference between when the data was assembled on the ground and the current GPS time.

Weather products are refreshed at specific intervals (defined in the **Refresh Rate** column in Table 6-1). If for any reason, a weather product is not refreshed within the **Expiration Time** intervals (see Table 6-1), the data is considered expired and is removed from the display, and the system displays dashes instead of the product age. This ensures that the displayed data is consistent with what is currently being transmitted by XM WX data services. If more than half of the expiration time has elapsed, the color of the product age displayed changes to yellow. If no data is currently available for a weather product, 'N/A' is displayed next to the weather product symbol instead of the product age. If a product age is invalid, the system displays dashes next to the symbol instead of an age.

Table 6-1 shows the weather product symbols, the expiration time and the refresh rate. The refresh rate represents the interval at which XM WX data services transmits new signals that may or may not contain new weather data. It does not represent the rate at which weather data is updated or new content is received by the Data Link Receiver. Weather data is updated at intervals that are defined and controlled by the XM WX data providers and are subject to change.



XM WX Weather Product	Symbol	Expiration Time (Minutes)	Refresh Rate (Minutes)
Next-generation Radar (NEXRAD)		30	5 (U.S.) 10 (Canada)
Cloud Top (CLD TOP)		60	15
Echo Top (ECHO TOP)		30	7.5
XM Lightning (LTNG)		30	5
Cell Movement (CELL MOV)		30	12
SIGMETs/AIRMETs (SIG/AIR)		60	12
Meteorological Aerodrome Report (METARs)		90	12
City Forecast (CITY)		60	12
Surface Analysis (SFC)		60	12
Freezing Levels (FRZ LVL)		60	12
Winds Aloft (WIND)		60	12
County Warnings (COUNTY)		60	5
Cyclone Warnings (CYCLONE)		60	12
Icing Potential (CIP and SLD) (ICNG)		90	22
Pilot Weather Report (PIREPs)		90	12
Air Report (AIREPs)		90	12
Turbulence (TURB)		180	12
Radar Coverage (RADAR CVRG)	no product image	30	5
Temporary Flight Restrictions (TFRs)	no product image	60	12
Terminal Aerodrome Reports (TAFs)	no product image	60	12

**Table 6-1 XM WX Weather Product Symbols and Data Timing**

Table 6-2 shows which XM WX products can be displayed (indicated with a '+' symbol) on specific maps.

XM WX Weather Product	PFD Inset Map	Navigation Map Page	XM Weather Data Link Page	Weather Information Page	AUX - Trip Planning Page	AUX - Video Page	Nearest Page Group	Flight Plan Pages
NEXRAD	+	+	+		+	+	+	+
Cloud Top (CLD TOP)			+					
Echo Top (ECHO TOP)			+					
XM Lightning (LTNG)	+	+	+		+	+	+	+
Cell Movement (CELL MOV)	+	+	+		+	+	+	+
SIGMETs/AIRMETs (SIG/AIR)			+					
METARs	+	+	+	+	+	+	+	+
City Forecast (CITY)			+					
Surface Analysis (SFC)			+					
Freezing Levels (FRZ LVL)			+					
Winds Aloft (WIND)		+*	+					
County Warnings (COUNTY)			+					
Cyclone Warnings (CYCLONE)			+					
Icing Potential (ICNG)			+					
PIREPs			+	+				
AIREPs			+	+				
Turbulence (TURB)			+					
Radar Coverage		+	+					
TFRs	+	+	+	+	+	+	+	+
TAFs			+	+				

\* Winds Aloft data is available inside Profile View when enabled on the Navigation Map Page.

**Table 6-2 XM WX Weather Product Display Maps**

Softkeys control the display of weather information on most MFD pages and the PFD Inset Map (Figure 6-3 shows the weather product softkeys for the XM Weather Data Link Page). When a weather product is selected for display, the corresponding softkey label changes to gray to indicate the product is enabled.

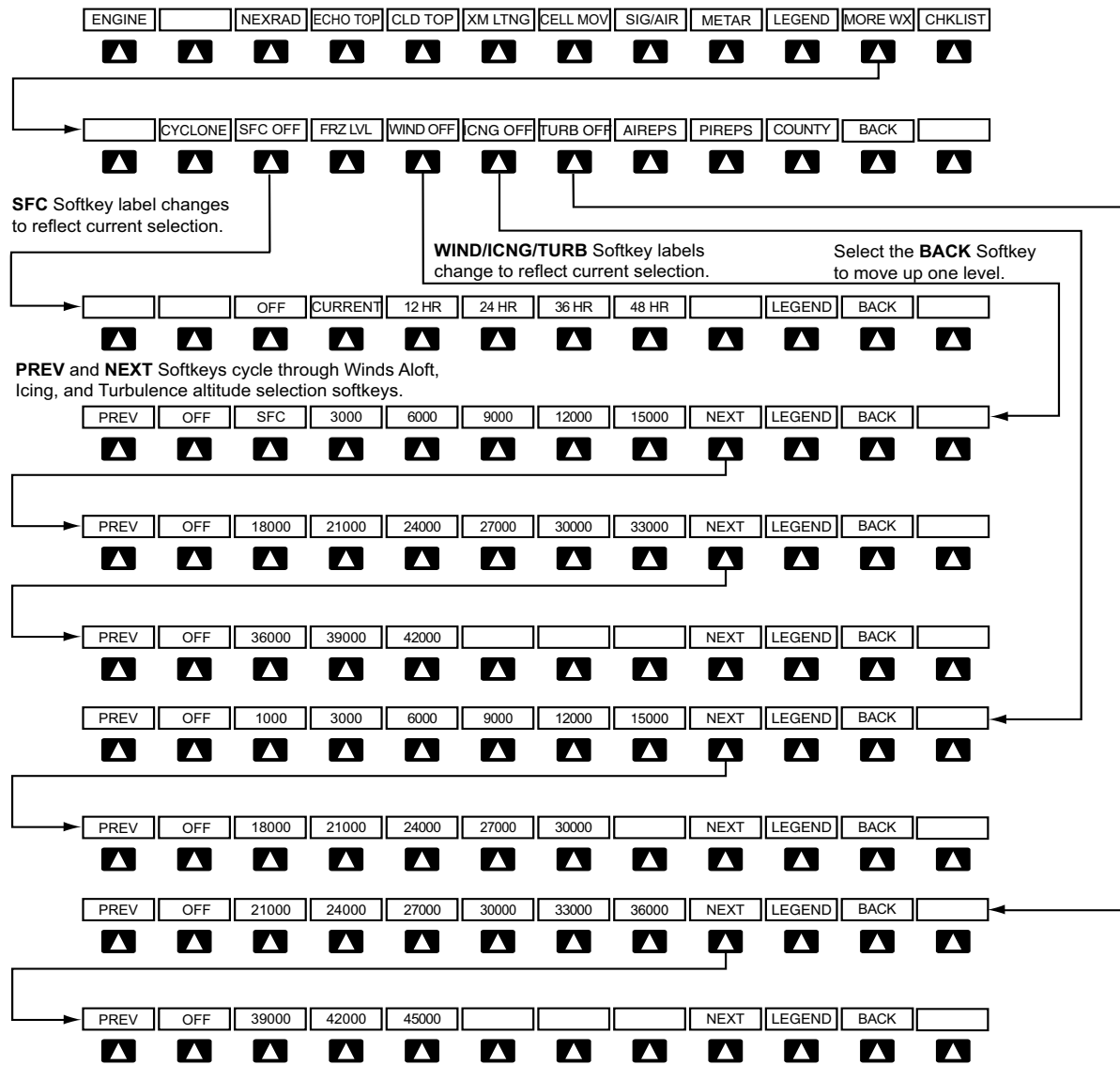

Figure 6-3 XM Weather Data Link Page Softkeys

The setup menus for the Navigation Map Page and the XM Weather Data Link Page control the map range settings above which weather products data are decluttered from the display. If a map range larger than the weather product map range setting is selected, the weather product data is removed from the map. The menus also provide a means in addition to the softkeys for enabling/disabling display of weather products.

**Setting up and customizing the XM Weather Data Link Page:**

- 1) Select the XM Weather Data Link Page.
- 2) Press the **MENU** Key.
- 3) With 'Weather Setup' highlighted, press the **ENT** Key (Figure 6-4).
- 4) Turn the small **FMS** Knob to select 'PRODUCT GROUP 1' or 'PRODUCT GROUP 2', and press the **ENT** Key (Figure 6-5).
- 5) Turn the large **FMS** Knob or press the **ENT** Key to scroll through product selections.
- 6) Turn the small **FMS** Knob to scroll through options for each product (ON/OFF, range settings, etc.).
- 7) Press the **ENT** Key to select an option.
- 8) Press the **FMS** Knob or **CLR** Key to return to the XM Weather Data Link Page with the changed settings.

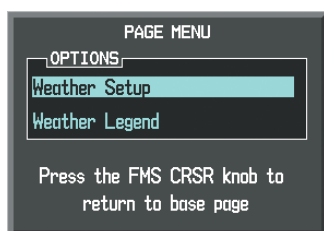

Figure 6-4 XM Weather Data Link Page Menu

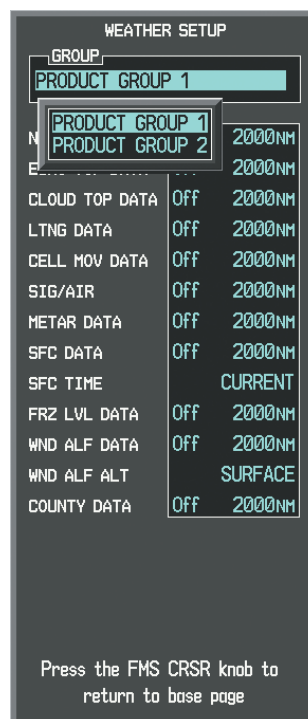

Figure 6-5 XM Weather Data Link Page Setup Menu

**Restoring default XM Weather Data Link Page settings:**

- 1) Select the XM Weather Data Link Page.
- 2) Press the **MENU** Key.
- 3) With 'Weather Setup' highlighted, press the **ENT** Key.
- 4) Press the **MENU** Key.
- 5) Highlight the desired default(s) to restore (all or for selection) and press **ENT** Key.

Maps besides the XM Weather Data Link Page use settings based on those selected for the Navigation Map Page.

**Setting up and customizing weather data for the Navigation Map Page:**

- 1) Select the Navigation Map Page.
- 2) Press the **MENU** Key.
- 3) With 'Map Setup' highlighted, press the **ENT** Key (Figure 6-6).
- 4) Turn the small **FMS** Knob to select the 'Weather' Group and press the **ENT** Key (Figure 6-7).
- 5) Turn the large **FMS** Knob or press the **ENT** Key to scroll through product selections (Figure 6-8).
- 6) Turn the small **FMS** Knob to scroll through options for each product (ON/OFF, range settings).
- 7) Press the **ENT** Key to select an option.
- 8) Press the **FMS** Knob or **CLR** Key to return to the Navigation Map Page with the changed settings.



**Figure 6-6 Navigation Map Page Menu**

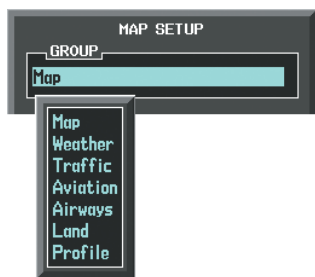

**Figure 6-7 Navigation Map Page Setup Menu**

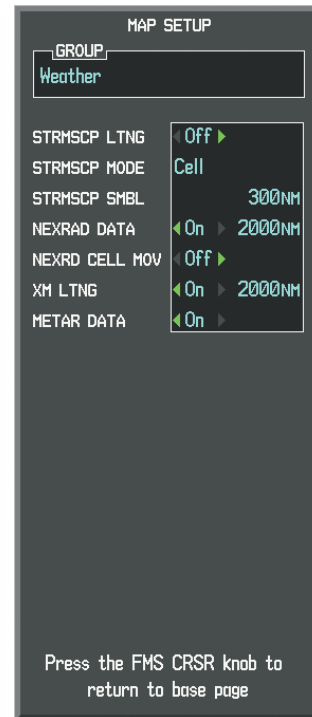

**Figure 6-8 Navigation Map Page Setup Menu, Weather Group**

Each active weather product has an associated legend which can be displayed on the XM Weather Data Link Page. A weather product legend can also be displayed on the Navigation Map Page for active XM WX weather products displayed on that page.

**Viewing legends for displayed weather products (on the XM Weather Data Link Page):**

- 1) Select the XM Weather Data Link Page.
- 2) Press the **LEGEND** Softkey to display the legends for the displayed weather products.

Or:

- a) Press the **MENU** Key.
- b) Select 'Weather Legend' and press the **ENT** Key.
- 3) Turn the **FMS** Knob to scroll through the legends if more are available than fit in the window.
- 4) To remove the Legend Window, press the **LEGEND** Softkey, the **ENT** or the **CLR** Key, or press the **FMS** Knob.

**Viewing legends for displayed weather products (on the Navigation Map Page):**

- 1) Select the Navigation Map Page.
- 2) Press the **MAP** Softkey.
- 3) Press the **LEGEND** Softkey (available if one or more XM weather products are enabled for display).
- 4) To remove the Legend Window, press the **LEGEND** Softkey, the **ENT** or the **CLR** Key, or press the **FMS** Knob.

Additional information about the following can be displayed by panning over the display on the map:

- Echo Tops
- Cell Movement
- SIGMETs
- AIRMETs
- METARs
- County Warnings
- TFRs
- PIREPs
- AIREPs

The map panning feature is enabled by pressing the **RANGE** Knob. The map range is adjusted by turning the **RANGE** Knob. If the map range is adjusted while panning is enabled, the map is re-centered on the Map Pointer.

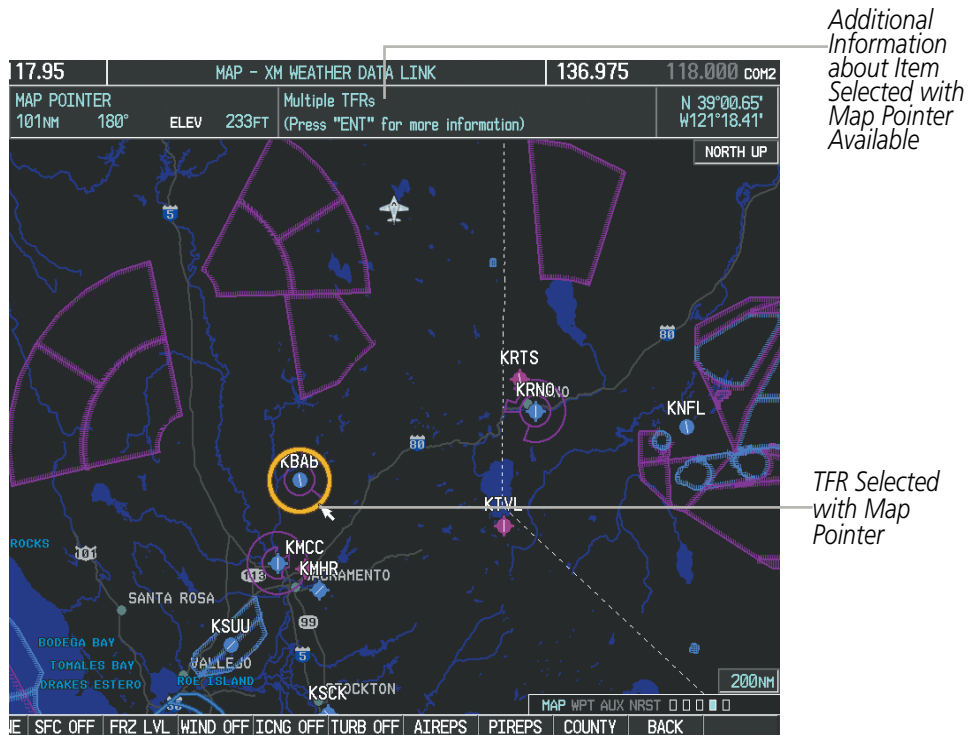

Figure 6-9 Panning on the XM Weather Data Link Page

NEXRAD



**NOTE:** NEXRAD cannot be displayed at the same time as echo tops, icing, turbulence, or terrain data.

WSR-88D, or NEXRAD (NEXt-generation RADar), is a network of 158 high-resolution Doppler radar systems that are operated by the National Weather Service (NWS). NEXRAD data provides centralized meteorological information for the continental United States and selected overseas locations. The maximum range of a single NEXRAD radar site is 250 nm. In addition to a wide array of services, the NEXRAD network provides important information about severe weather and air traffic safety.

NEXRAD data is not real-time. The lapsed time between collection, processing, and dissemination of NEXRAD images can be significant and may not reflect the current radar synopsis. Due to the inherent delays and the relative age of the data, it should be used for long-range planning purposes only. Never use NEXRAD data or any radar data to penetrate hazardous weather. Rather, use it in an early-warning capacity of pre-departure and enroute evaluation.

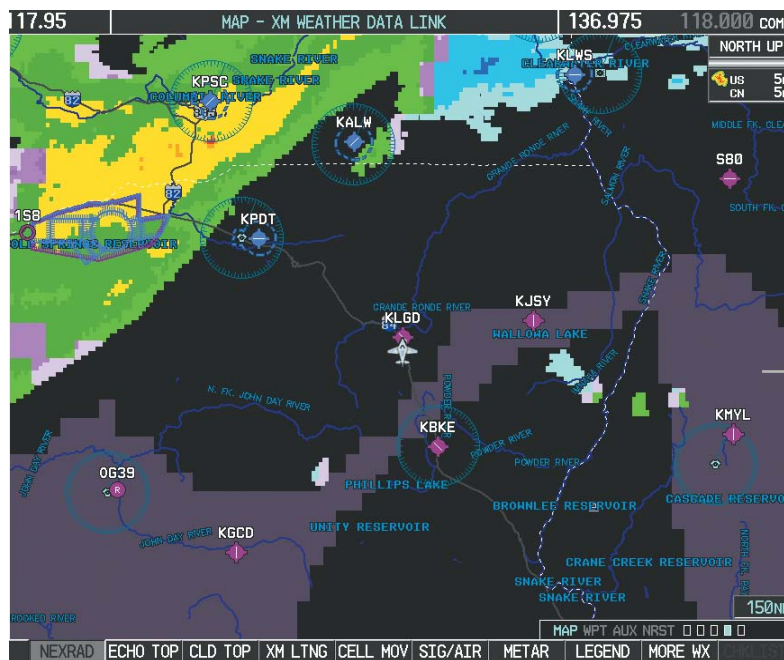

Figure 6-10 NEXRAD Data on the XM Weather Data Link Page

NEXRAD data can be displayed on the following maps:

- PFD Inset Map
- Navigation Map Page
- XM Weather Data Link Page
- Airport Information Page
- Trip Planning Page
- Nearest Pages
- Flight Plan Pages
- AUX-Video Page



**Displaying NEXRAD weather information:**

- 1) Press the **MAP** Softkey (for the PFD Inset Map, press the **INSET** Softkey). This step is not necessary on the XM Weather Data Link Page.
- 2) Press the **NEXRAD** Softkey.

Composite data from all the NEXRAD radar sites in the United States is shown. This data is composed of the maximum reflectivity from the individual radar sweeps. The display of the information is color-coded to indicate the weather severity level. All weather product legends can be viewed on the XM Weather Data Link Page. For the NEXRAD legend (Figure 6-11), press the **LEGEND** Softkey when NEXRAD is selected for display.

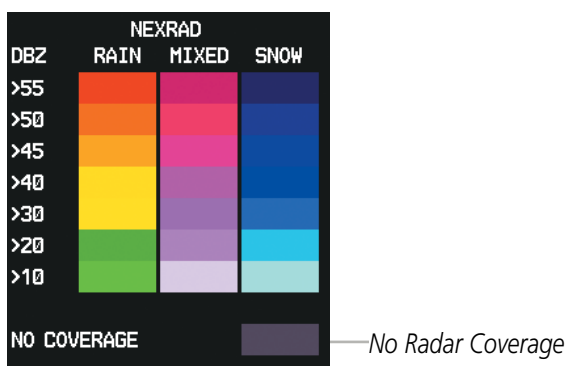

Figure 6-11 NEXRAD Data with Legend

The display of radar coverage is always active when either NEXRAD or Echo Tops is selected. Areas where NEXRAD radar coverage and Echo Tops information is not currently available or is not being collected are indicated in gray shade of purple.

**REFLECTIVITY**

Reflectivity is the amount of transmitted power returned to the radar receiver. Colors on the NEXRAD display are directly correlative to the level of detected reflectivity. Reflectivity as it relates to hazardous weather can be very complex.

The role of radar is essentially to detect moisture in the atmosphere. Simply put, certain types of weather reflect radar better than others. The intensity of a radar reflection is not necessarily an indication of the weather hazard level. For instance, wet hail returns a strong radar reflection, while dry hail does not. Both wet and dry hail can be extremely hazardous.

The different NEXRAD echo intensities are measured in decibels (dB) relative to reflectivity (Z). NEXRAD measures the radar reflectivity ratio, or the energy reflected *back to* the radar receiver (designated by the letter Z). The value of Z increases as the returned signal strength increases.

### NEXRAD LIMITATIONS

NEXRAD radar images may have certain limitations:

- NEXRAD base reflectivity does not provide sufficient information to determine cloud layers or precipitation characteristics (wet hail vs. rain). For example, it is not possible to distinguish between wet snow, wet hail, and rain.
- NEXRAD base reflectivity is sampled at the minimum antenna elevation angle. An individual NEXRAD site cannot depict high altitude storms at close ranges. It has no information about storms directly over the site.
- When zoomed in to a range of 30 nm, each square block on the display represents an area of four square kilometers. The intensity level reflected by each square represents the *highest* level of NEXRAD data sampled within the area (Figure 6-12).

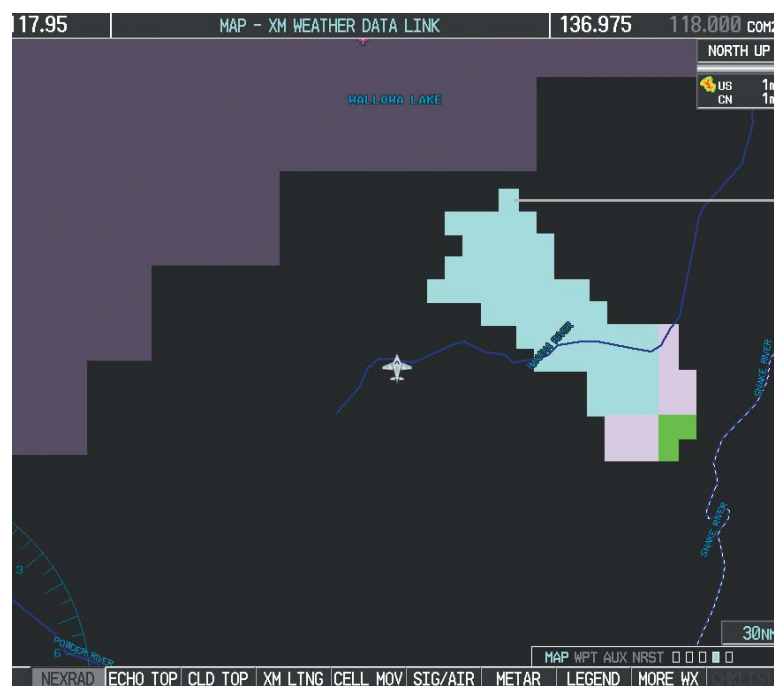

Figure 6-12 NEXRAD Data - Zoomed

The following may cause abnormalities in displayed NEXRAD radar images:

- Ground clutter
- Strokes and spurious radar data
- Sun strokes (when the radar antenna points directly at the sun)
- Interference from buildings or mountains, which may cause shadows
- Metallic dust from military aircraft, which can cause alterations in radar scans

## NEXRAD LIMITATIONS (CANADA)

- Radar coverage extends to 55°N.
- Any precipitation displayed between 52°N and 55°N is shown as mixed precipitation regardless of actual precipitation type.

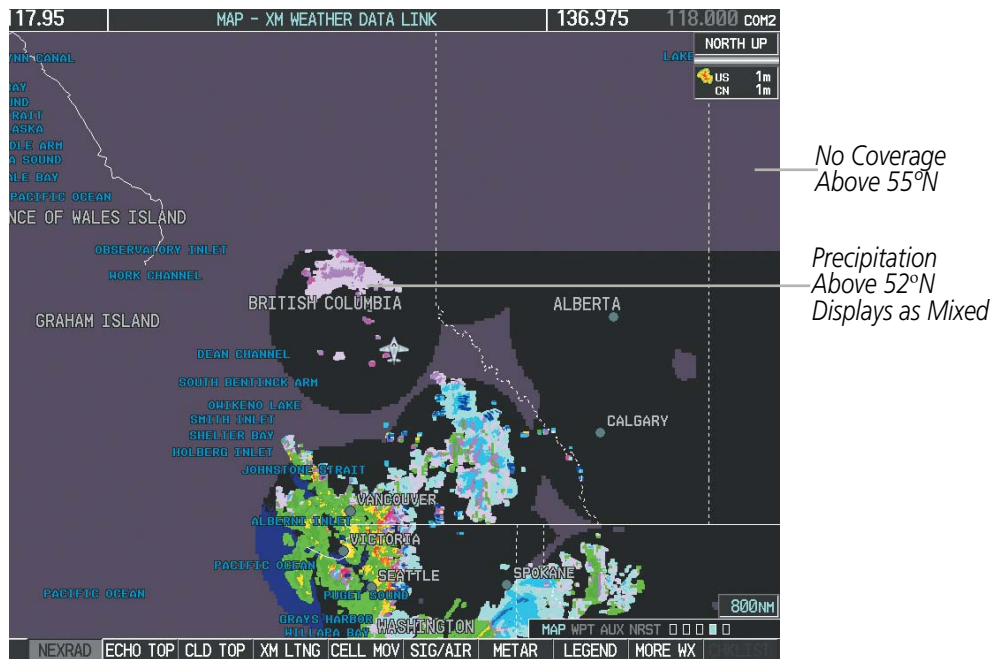

Figure 6-13 NEXRAD Data - Canada

ECHO TOPS



**NOTE:** Echo Tops cannot be displayed at the same time as Cloud Tops or NEXRAD.

Echo Tops data (Figure 6-14) shows the location, elevation, and direction of the highest radar echo. The highest radar echo does not indicate the top of a storm or clouds; rather it indicates the highest altitude at which precipitation is detected. Information is derived from NEXRAD data.

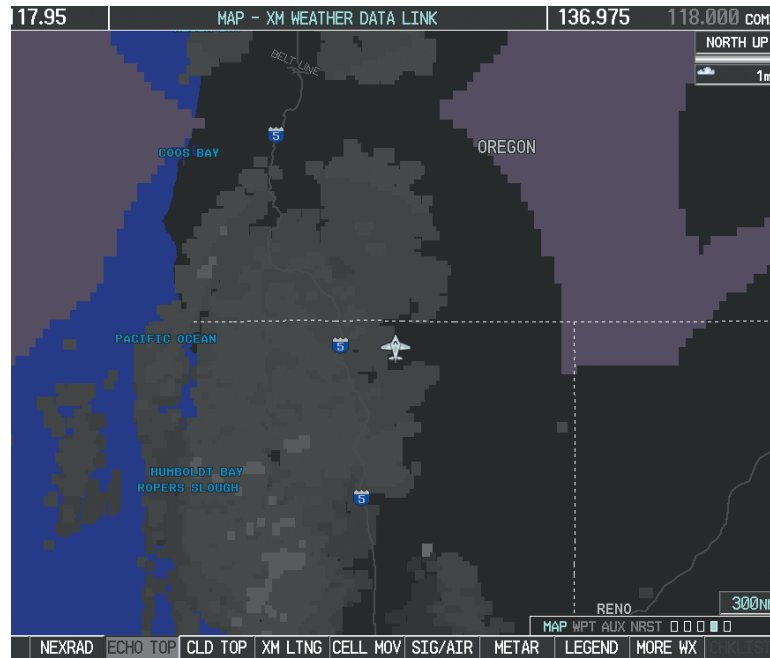

Figure 6-14 Echo Tops Data

**Displaying Echo Tops information:**

- 1) Select the XM Weather Data Link Page.
- 2) Press the **ECHO TOP** Softkey.

To display the Echo Tops legend (Figure 6-15), press the **LEGEND** Softkey when Echo Tops is selected for display. Since Echo Tops and Cloud Tops use the same color scaling to represent altitude, display of these weather products is mutually exclusive. When Echo Tops is activated, NEXRAD and Cloud Tops data are removed.

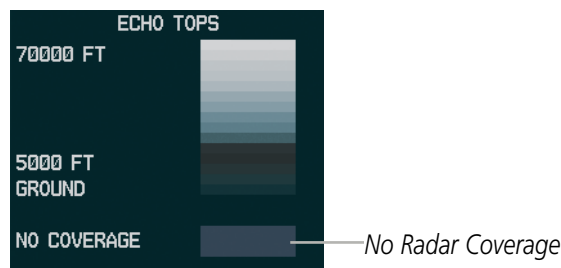

Figure 6-15 Echo Tops Legend

The display of no radar coverage is always active when either NEXRAD or Echo Tops is selected. Areas where NEXRAD radar coverage and Echo Tops information is not currently available or is not being collected are indicated in a gray shade of purple.

## CLOUD TOPS



**NOTE:** *Cloud Tops and Echo Tops cannot be displayed at the same time.*

Cloud Tops data (Figure 6-16) depicts cloud top altitudes as determined from satellite imagery.

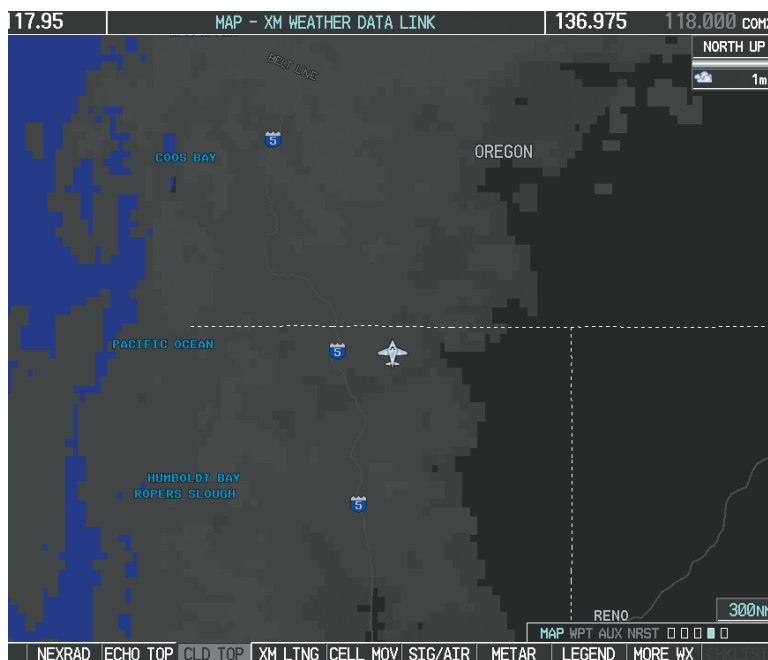

Figure 6-16 Cloud Tops Data

### Displaying Cloud Tops information:

- 1) Select the XM Weather Data Link Page.
- 2) Press the **CLD TOP** Softkey.

To display the Cloud Tops legend (Figure 6-17), press the **LEGEND** Softkey when Cloud Tops is selected for display. Since Cloud Tops and Echo Tops use the same color scaling to represent altitude, display of these weather products is mutually exclusive. When Cloud Tops is activated, Echo Tops data is removed.

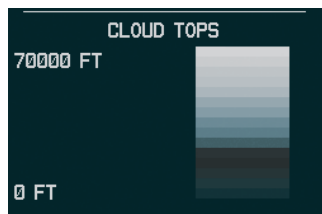

Figure 6-17 Cloud Tops Legend

XM LIGHTNING



**NOTE:** XM Lightning and optional L-3 Stormscope® WX-500 Lightning data cannot be displayed at the same time.

XM Lightning data (Figure 6-18) shows the approximate location of cloud-to-ground lightning strikes. A strike icon represents a strike that has occurred within a two-kilometer region. The exact location of the lightning strike is not displayed.

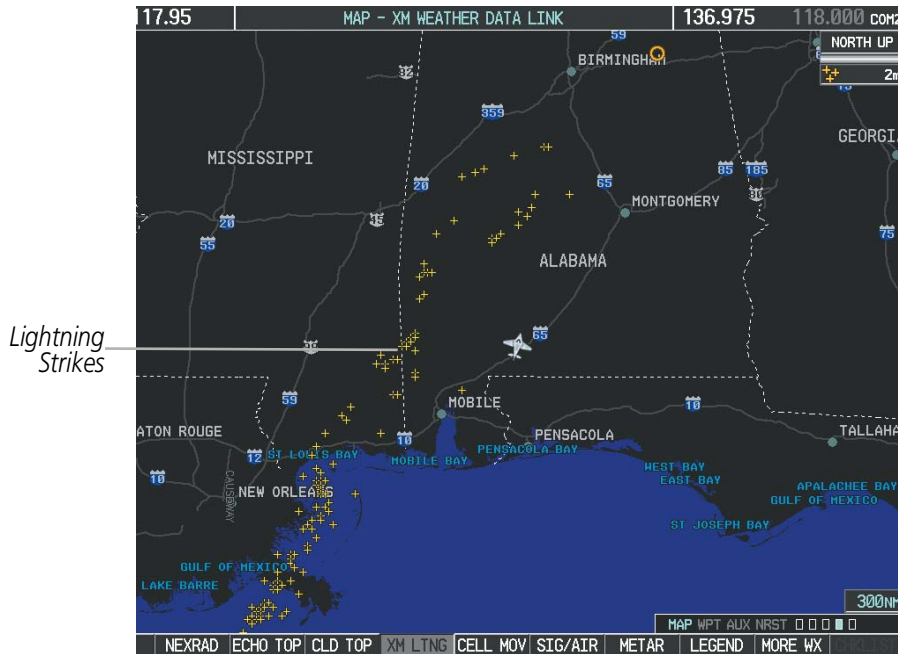

Figure 6-18 Lightning Data

XM Lightning data displays on the following maps:

- PFD Inset Map
- Navigation Map Page
- XM Weather Data Link Page
- Trip Planning Page
- Nearest Pages
- Flight Plan Pages

**Displaying XM Lightning information:**

- 1) Press the **MAP** Softkey (for the PFD Inset Map, press the **INSET** Softkey). This step is not necessary on the XM Weather Data Link Page.
- 2) Press the **XM LTNG** Softkey (**LTNG** Softkey on the XM Weather Data Link Page).

To display the XM Lightning legend on the XM Weather Data Link Page (Figure 6-19), press the **LEGEND** Softkey when XM Lightning is selected for display.

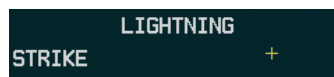

Figure 6-19 Lightning Legend

## CELL MOVEMENT

Cell Movement data (Figure 6-20) shows the location and movement of storm cells as identified by the ground-based system. Cells are represented by yellow squares, with direction of movement indicated with short, orange arrows.

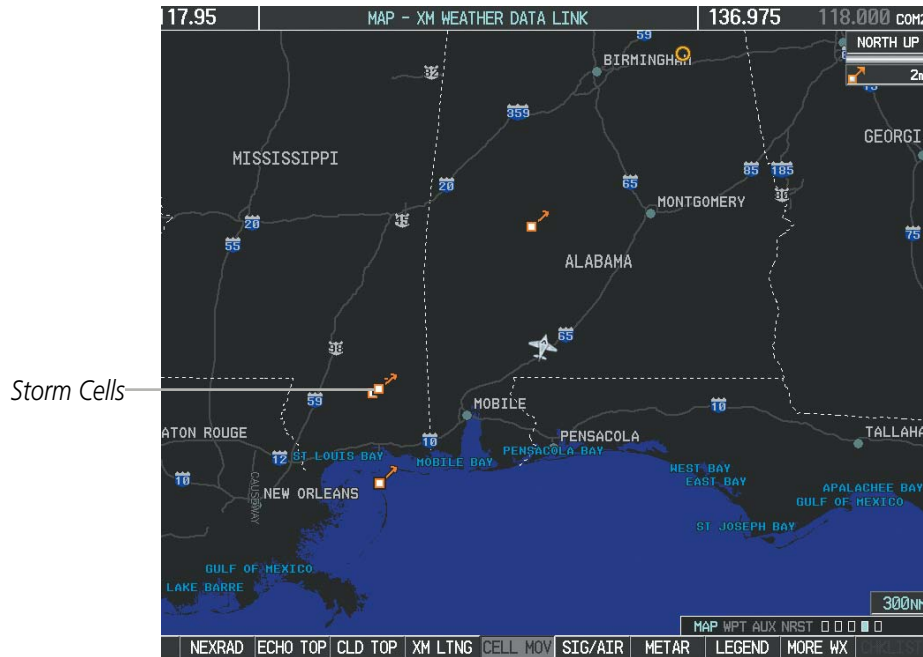

Figure 6-20 Cell Movement Data

On most applicable maps, Cell Movement data is selected for display along with NEXRAD. On the XM Weather Data Link Page, Cell Movement data can be selected independently. Cell Movement data can be displayed on the following maps:

- PFD Inset Map
- Navigation Map
- AUX - Trip Planning Page
- AUX - Video Page
- Nearest Pages

### Displaying Cell Movement information:

- 1) Press the **MAP** Softkey (for the PFD Inset Map, press the **INSET** Softkey). This step is not necessary on the XM Weather Data Link Page.
- 2) Press the NEXRAD Softkey (CEL MOV Softkey on the XM Weather Data Link Page). For Cell Movement to be displayed on maps other than the XM Weather Data Link Page, Cell Movement must be turned on in the Navigation Map Setup Menu (see the procedure “Setting up and customizing weather data for the Navigation Map Page”).

To display the Cell Movement legend on the XM Weather Data Link Page, (Figure 6-21), press the **LEGEND** Softkey when Cell Movement is selected for display.

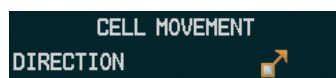

Figure 6-21 Cell Movement Legend



### SIGMETs AND AIRMETs

SIGMETs (SIGnificant METeorological Information) and AIRMETs (AIRmen's METeorological Information) are issued for potentially hazardous weather. A Convective SIGMET is issued for hazardous convective weather such as severe or widespread thunderstorms.

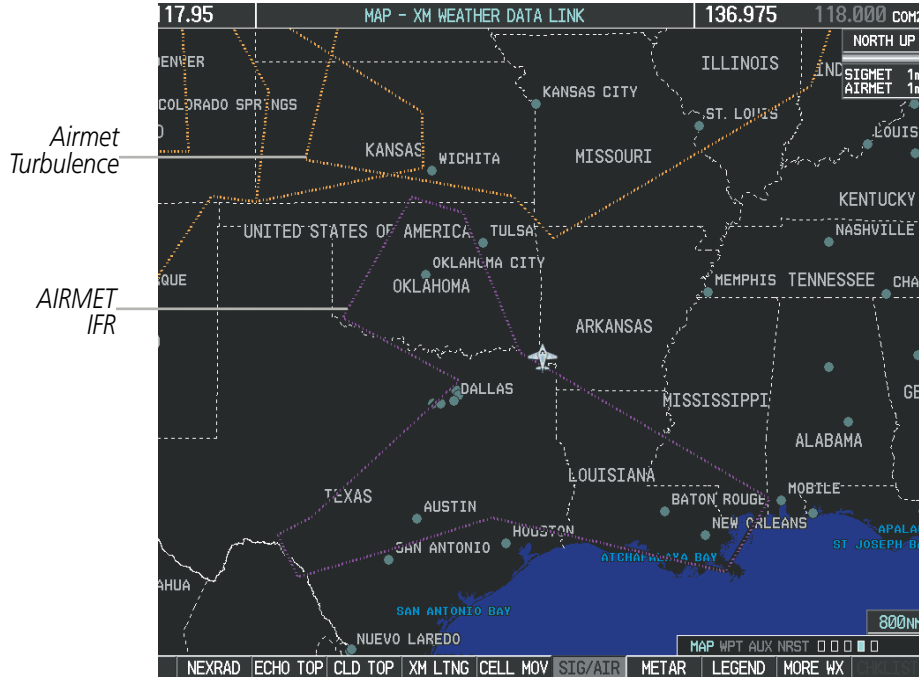

Figure 6-22 SIGMET/AIRMET Data

#### Displaying SIGMETs and AIRMETs:

- 1) Select the XM Weather Data Link Page.
- 2) Press the **SIG/AIR** Softkey.
- 3) To view the text of the SIGMET or AIRMET, press the **RANGE** Knob and move the Map Pointer over the icon.
- 4) Press the **ENT** key. Figure 6-23 shows sample SIGMET text.

To display the SIGMET and AIRMET legend (Figure 6-24), press the **LEGEND** Softkey when SIGMETs and AIRMETs are selected for display.

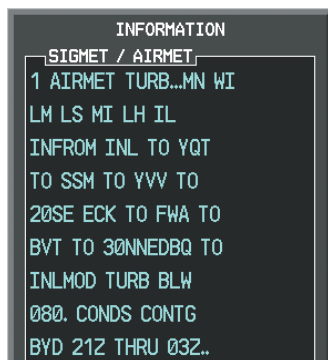

Figure 6-23 Sample SIGMET Text



Figure 6-24 SIGMET/AIRMET Legend

## METARS AND TAFS

**NOTE:** Atmospheric pressure as reported for METARs is given in hectopascals (hPa), except for in the United States, where it is reported in inches of mercury (in Hg). Temperatures are reported in Celsius.

**NOTE:** METAR information is only displayed within the installed navigation database service area.

METARs (METeorological Aerodrome Reports) typically contain information about the temperature, dewpoint, wind, precipitation, cloud cover, cloud heights, visibility, and barometric pressure at an airport or observation station. They can also contain information on precipitation amounts, lightning, and other critical data. METARs reflect hourly observations; non-routine updates include the code “SPECI” in the report. METARs are shown as colored flags at airports that provide them.

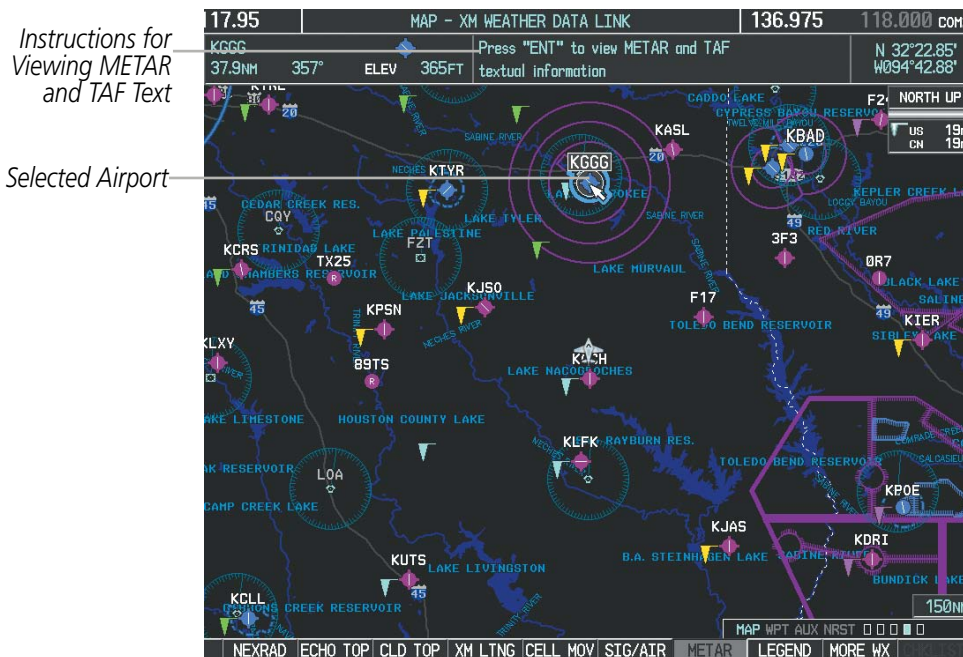

Figure 6-25 METAR Flags on the XM Weather Data Link Page

TAFs (Terminal Aerodrome Forecasts) are weather predictions for specific airports within a 24-hour period, and may span up to 36 hours. TAFs typically include forecast wind, visibility, weather phenomena, and sky conditions using METAR codes.

METAR and TAF text are displayed on the Weather Information Page. METAR data is displayed first in a decoded fashion, then as raw text. TAF information is displayed only in its raw form when it is available.

#### Displaying METAR and TAF text:

- 1) On the XM Weather Data Link Page, press the **METAR** Softkey.
- 2) Press the **RANGE** Knob and pan to the desired airport.
- 3) Press the **ENT** Key. The Weather Information Page is shown with METAR and TAF text.

4) Use the **FMS** Knob or the **ENT** Key to scroll through the METAR and TAF text. METAR text must be completely scrolled through before scrolling through the TAF text.

5) Press the **FMS** Knob or the **CLR** Key to return to the XM Weather Data Link Page.

Or:

1) Select the Weather Information Page.

a) Turn the large **FMS** Knob to select the Waypoint Page Group.

b) Press the **WX** Softkey to select the Weather Information Page.

2) Press the **FMS** Knob to display the cursor.

3) Use the **FMS** Knob to enter the desired airport and press the **ENT** Key.

4) Use the **FMS** Knob or the **ENT** Key to scroll through the METAR and TAF text. Note that the METAR text must be completely scrolled through before scrolling through the TAF text.

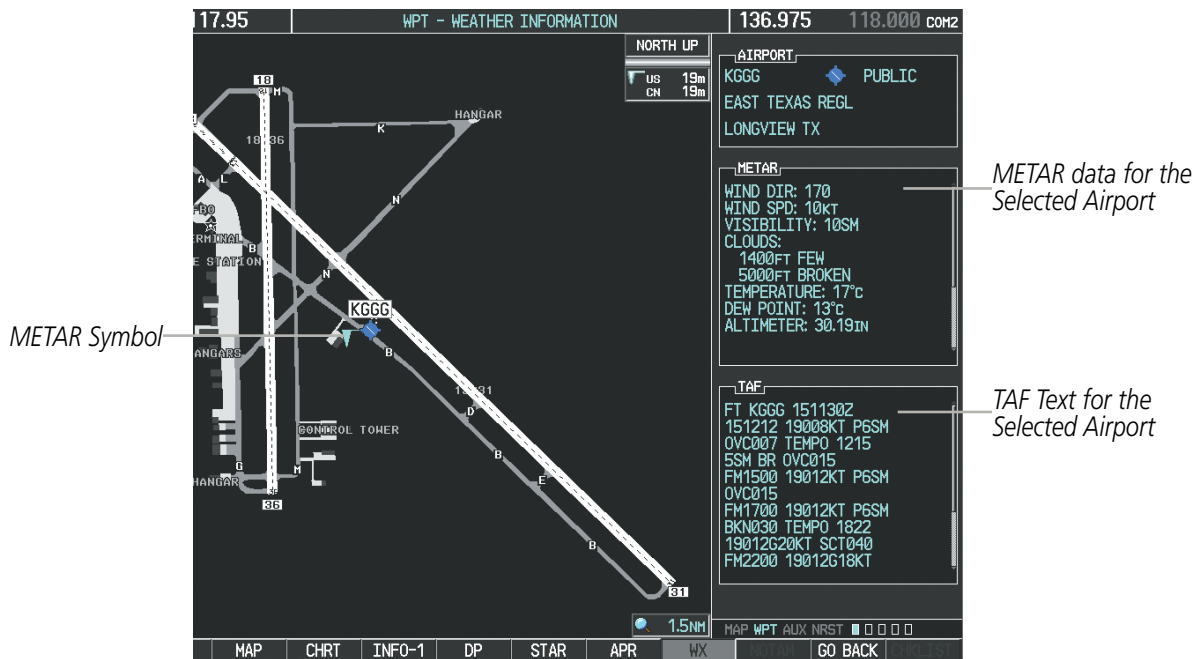

Figure 6-26 METAR and TAF Text on the Weather Information Page

Raw METAR text is also accessible while panning the map cursor over a METAR flag on any map page on which a METAR is displayed. The METAR text is shown in a box near the METAR flag.

In addition, METAR flags and their associated text are displayed on the Active Flight Plan Page on the MFD. A METAR flag is shown next to waypoint(s) in the flight plan with an available METAR.

**Displaying raw METAR text on the Active Flight Plan Page:**

- 1) Select the Active Flight Plan Page on the MFD.
- 2) Press the **FMS** Knob to activate the cursor.
- 3) Turn the large **FMS** Knob to highlight the desired waypoint. The METAR text will appear in the 'SELECTED WAYPOINT WEATHER' window below.
- 4) When finished, press the **FMS** Knob to remove the cursor or press the **FPL** Key to exit the Active Flight Plan Page.

To display the METAR legend on the XM Weather Data Link Page (Figure 6-27), press the **LEGEND** Softkey when METARs are selected for display.

The METAR flag color is determined by the information in the METAR text. A gray METAR flag is displayed when the METAR text does not contain adequate information.



Figure 6-27 METAR Legend

SURFACE ANALYSIS AND CITY FORECAST



**NOTE:** Surface Analysis and City Forecast data are displayed only within the installed navigation database service area.

Surface Analysis and City Forecast information (Figure 6-28) is available for current and forecast weather conditions. Forecasts are available for intervals of 12, 24, 36, and 48 hours.

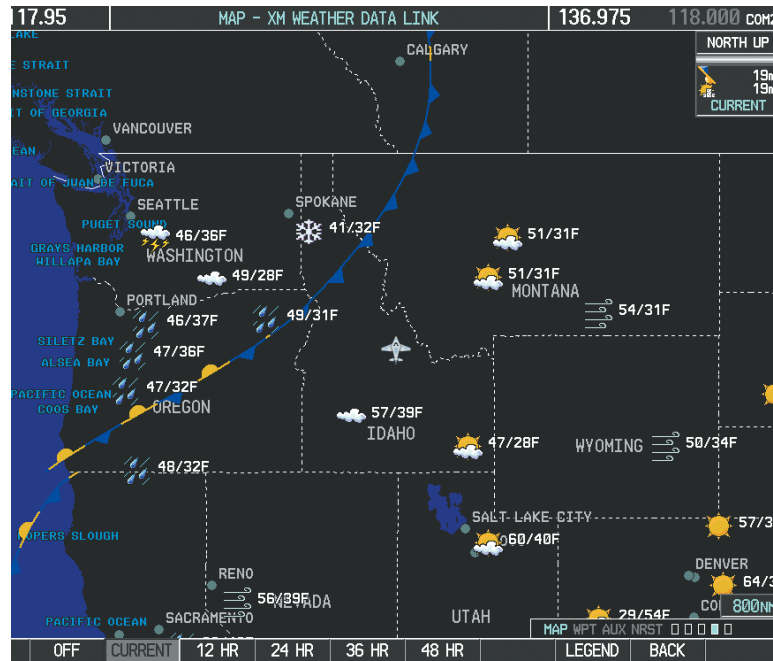

Figure 6-28 Current Surface Analysis Data

Displaying Surface Analysis and City Forecast information:

- 1) Select the XM Weather Data Link Page.
- 2) Press the **MORE WX** Softkey.
- 3) Press the **SFC** Softkey.
- 4) Select the desired forecast time: **CURRENT, 12 HR, 24 HR, 36 HR, or 48 HR**. The **SFC** Softkey label changes to reflect the forecast time selected.

To display the Surface Analysis and City Forecast legend (Figure 6-29), press the **LEGEND** Softkey when Surface Analysis and City Forecast are selected to be displayed.

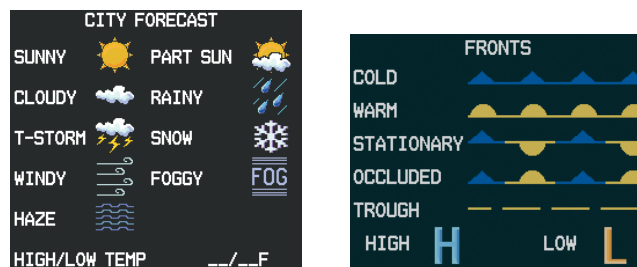

Figure 6-29 City Forecast and Surface Analysis Legend

## FREEZING LEVELS

Freezing Level data (Figure 6-30) shows the color-coded contour lines for the altitude and location at which the first isotherm is found. When no data is displayed for a given altitude, the data for that altitude has not been received, or is out of date and has been removed from the display. New data appears at the next update.

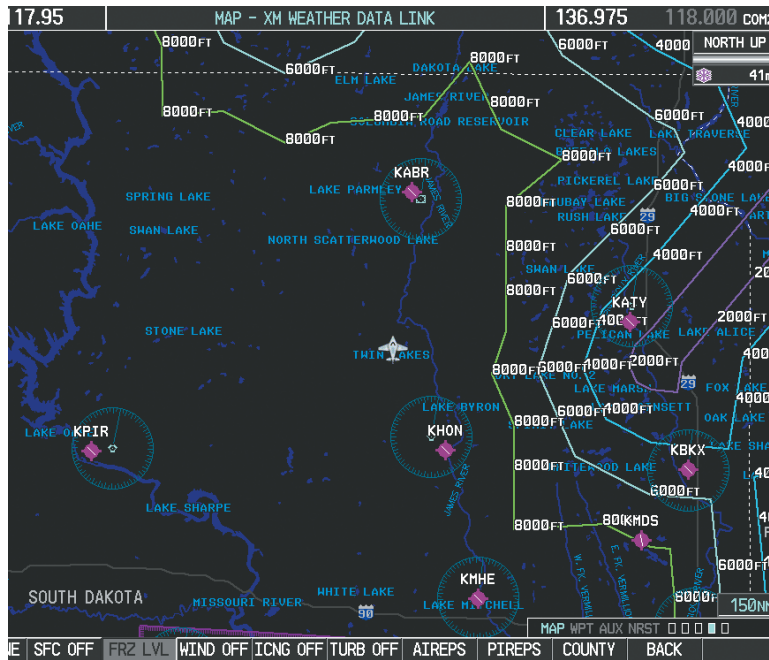

Figure 6-30 Freezing Level Data

### Displaying Freezing Level information:

- 1) Select the XM Weather Data Link Page.
- 2) Press the **MORE WX** Softkey.
- 3) Press the **FRZ LVL** Softkey.

To display the Freezing Level legend (Figure 6-31), press the **LEGEND** Softkey when Freezing Level data is selected to be displayed.



Figure 6-31 Freezing Level Legend



## WINDS ALOFT

Winds Aloft data (Figure 6-32) shows the forecasted wind speed and direction at the surface and at selected altitudes. Altitude can be displayed in 3,000-foot increments up to 42,000 feet MSL.

### Displaying Winds Aloft data:

- 1) Select the XM Weather Data Link Page.
- 2) Press the **MORE WX** Softkey.
- 3) Press the **WIND** Softkey.
- 4) Select the desired altitude level: SFC (surface) up to 42,000 feet. Press the **NEXT** or **PREV** Softkey to cycle through the altitude softkeys. The **WIND** Softkey label changes to reflect the altitude selected.

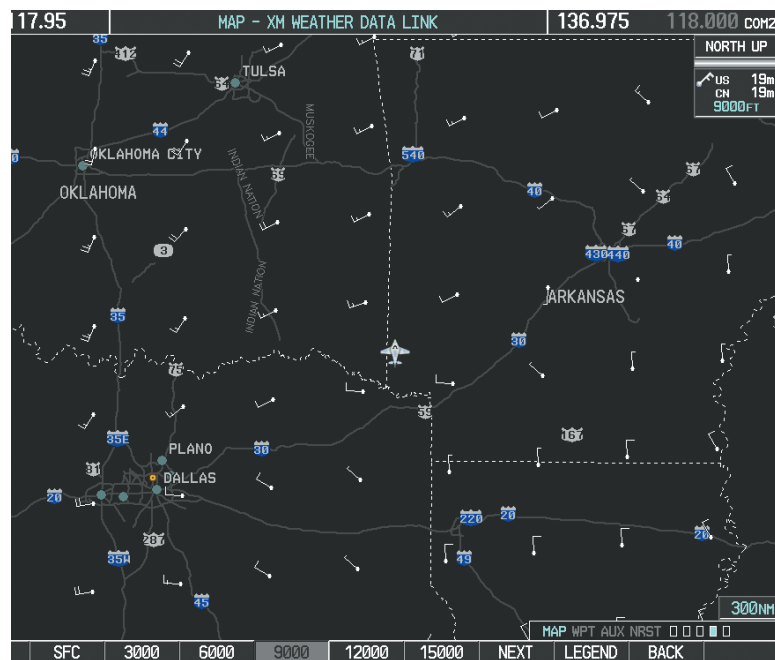

Figure 6-32 Winds Aloft Data at 9,000 Feet

To display the Winds Aloft legend (Figure 6-33), press the **LEGEND** Softkey when Winds Aloft is selected for display.

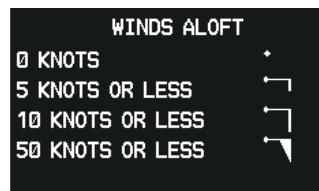

Figure 6-33 Winds Aloft Data with Legend

Headwind and tailwind components aloft are available inside the Profile View on the Navigation Map Page (Figure 6-34). The displayed components are relative to current aircraft altitude and track, but not to aircraft speed.



- SYSTEM OVERVIEW
- FLIGHT INSTRUMENTS
- EIS
- AUDIO PANEL & CNS
- FLIGHT MANAGEMENT
- HAZARD AVOIDANCE
- AFCS
- ADDITIONAL FEATURES
- APPENDICES
- INDEX

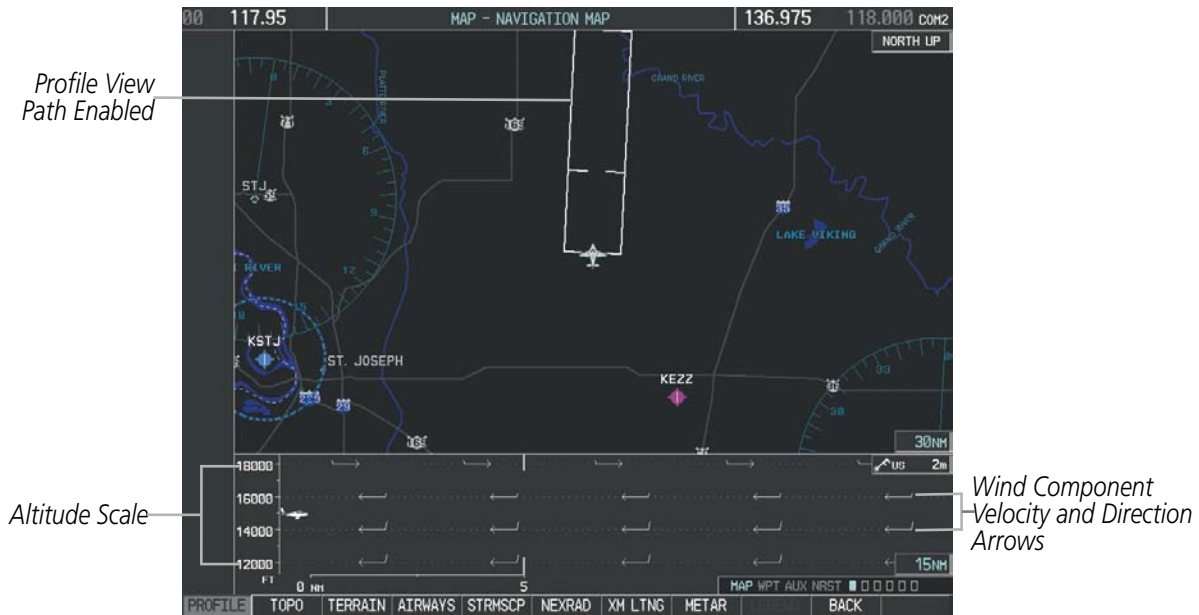

Figure 6-34 Winds Aloft Data Inside Profile View (Navigation Map Page)

Arrows pointing to the left indicate headwind components; tailwind component arrows point to the right, as shown in Table 6-3.

Headwind Symbol	Tailwind Symbol	Headwind/Tailwind Component
None	None	Less than 5 knots
		5 knots
		10 knots
		50 knots

Table 6-3 Profile View Headwind/Tailwind Component Symbols

**Showing/Hiding Profile View (containing winds aloft data)**

- 1) Select the Navigation Map Page.
  - 2) Press the **PROFILE** Softkey.
- Or:**
- 1) Press the **MENU** Key.
  - 2) Turn the large FMS Knob to highlight 'Show Profile View' or 'Hide Profile View' (choice dependent on current state) and press the **ENT** Key.

Winds Aloft data inside the Profile View is enabled by default when the Profile View is displayed on the Navigation Map Page. This behavior can be changed on the Navigation Map Page.

**Enabling/disabling winds aloft data display in Profile View:**

- 1) Select the Navigation Map Page.
- 2) Press the **MENU** Key.
- 3) With Map Setup highlighted, press the **ENT** Key (Figure 6-35).
- 4) Turn the small **FMS** Knob to select the Profile Group and press the **ENT** Key (Figure 6-36).
- 5) Turn the large **FMS** Knob to select 'Profile Winds' (Figure 6-37).
- 6) Turn the small **FMS** Knob to select 'On' or 'Off'.
- 7) Press the **FMS** Knob or **CLR** Key to return to the Navigation Map Page with the changed settings.

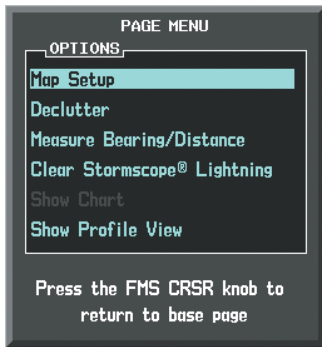

Figure 6-35 Navigation Map Page Menu



Figure 6-36 Navigation Map Page Setup Menu

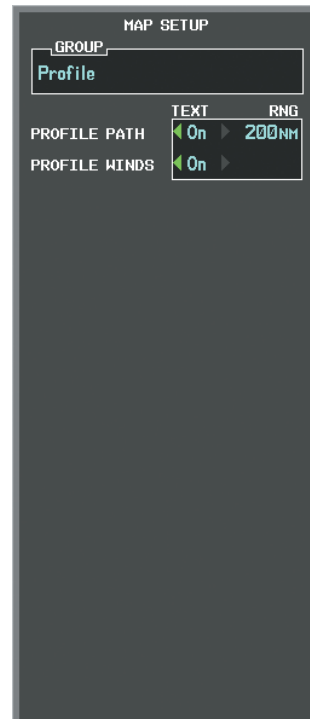
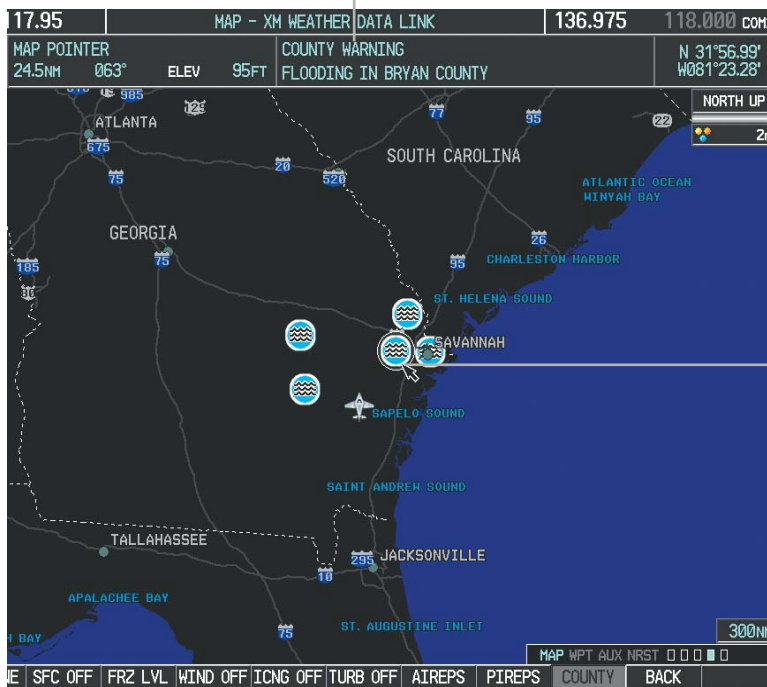

Figure 6-37 Navigation Map Page Setup Menu, Weather Group

## COUNTY WARNINGS

County data (Figure 6-38) provides specific public awareness and protection weather warnings from the National Weather Service (NWS). This can include information on tornadoes, severe thunderstorms, and flood conditions.



*Additional Information on Flood Warning Selected with Map Pointer*

*Selected Flood Warning*

Figure 6-38 County Flood Warning

### Displaying County Warning information:

- 1) Select the XM Weather Data Link Page.
- 2) Press the **MORE WX** Softkey.
- 3) Press the **COUNTY** Softkey.

To display the County Warnings legend (Figure 6-39), press the **LEGEND** Softkey when County Warnings are displayed.

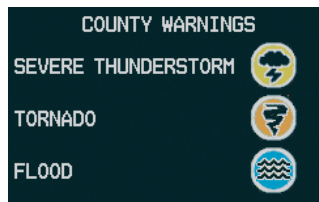

Figure 6-39 County Warnings Legend

CYCLONE

The Cyclone weather product (Figure 6-40) shows the current location of cyclones (hurricanes), tropical storms, and their projected tracks.



Figure 6-40 Cyclone Data with Projected Track

Displaying cyclone (hurricane) track information:

- 1) Select the XM Weather Data Link Page.
- 2) Press the **MORE WX** Softkey.
- 3) Press the **CYCLONE** Softkey.

To display the Cyclone legend (Figure 6-41), press the **LEGEND** Softkey when Cyclone data is displayed.

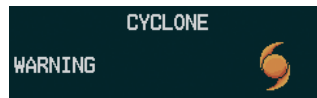

Figure 6-41 Cyclone Legend

## ICING (CIP &amp; SLD)



**NOTE:** Icing data cannot be displayed at the same time as NEXRAD data.

Current Icing Product (CIP) data shows a graphical view of the current icing environment (Figure 6-42). Icing severity is displayed in four categories: light, moderate, severe, and extreme (not specific to aircraft type). The CIP product is not a forecast, but a presentation of the current conditions at the time of the analysis.

Supercooled Large Droplet (SLD) icing conditions are characterized by the presence of relatively large, super cooled water droplets indicative of freezing drizzle and freezing rain aloft. SLD threat areas are depicted as magenta dots over the CIP colors.

## Displaying Icing data:

- 1) Select the XM Weather Data Link Page.
- 2) Press the **MORE WX** Softkey.
- 3) Press the **ICNG** Softkey.
- 4) Select the desired altitude level: 1,000 feet up to 30,000 feet. Press the **NEXT** or **PREV** Softkey to cycle through the altitude softkeys. The **ICNG** Softkey label changes to reflect the altitude selected.

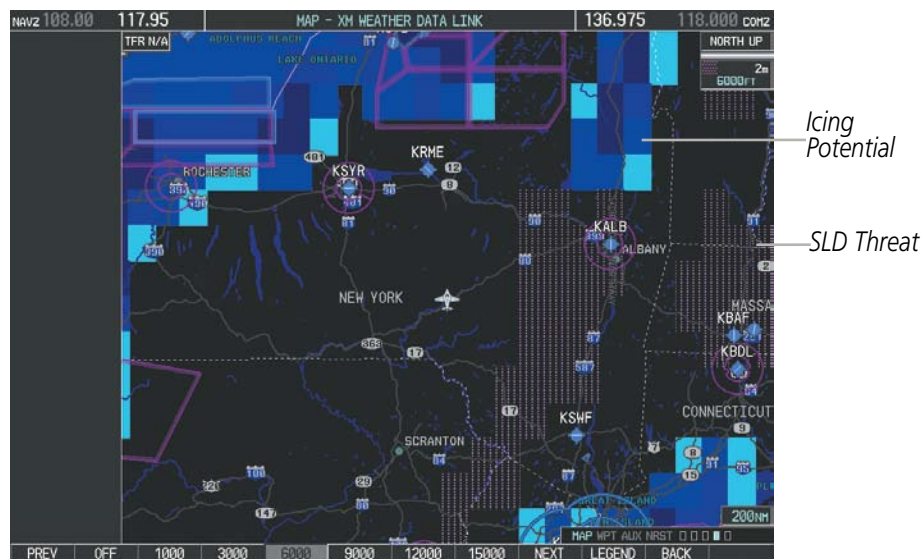

Figure 6-42 Icing Data at 6,000 Feet

To display the Icing Potential legend (Figure 6-43), press the **LEGEND** Softkey when Icing data is displayed.

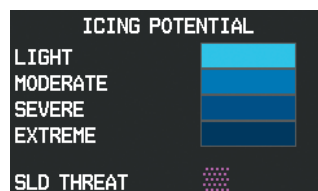

Figure 6-43 Icing Potential Legend

TURBULENCE



**NOTE:** Turbulence data cannot be displayed at the same time as NEXRAD data.

Turbulence data (Figure 6-44) identifies the potential for erratic movement of high-altitude air mass associated winds. Turbulence is classified as light, moderate, severe or extreme, at altitudes between 21,000 and 45,000 feet. Turbulence data is intended to supplement AIRMETs and SIGMETs.

**Displaying Turbulence data:**

- 1) Select the XM Weather Data Link Page.
- 2) Press the **MORE WX** Softkey.
- 3) Press the **TURB** Softkey.
- 4) Select the desired altitude level: 21,000 feet up to 45,000 feet. Press the **NEXT** or **PREV** Softkey to cycle through the altitude softkeys. The **TURB** Softkey label changes to reflect the altitude selected.

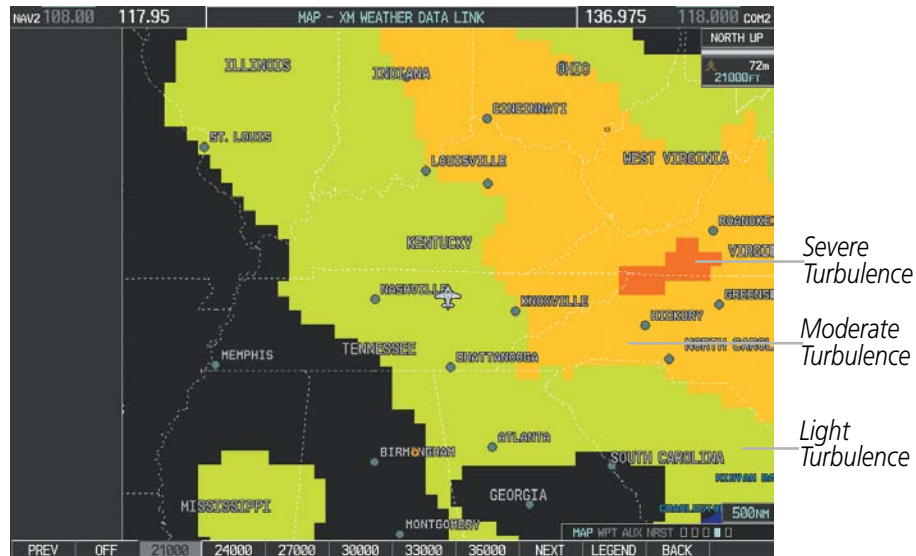

Figure 6-44 Turbulence Data at 21,000 Feet

To display the Turbulence legend (Figure 6-45), press the **LEGEND** Softkey when Turbulence is selected for display.

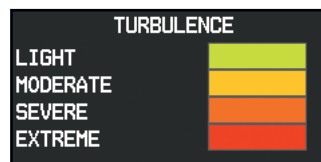

Figure 6-45 Turbulence Legend



## PIREPS AND AIREPS

Pilot Weather Reports (PIREPs) describe in-flight weather encountered by pilots. When significant weather conditions are reported or forecast, Air Traffic Control (ATC) facilities are required to solicit PIREPs. A PIREP may contain adverse weather conditions, such as low in-flight visibility, icing conditions, wind shear, turbulence, and type of aircraft flown. PIREPs are issued as either Routine (UA) or Urgent (UUA).

Another type of PIREP is an Air Report (AIREP). AIREPs are used almost exclusively by commercial airlines.

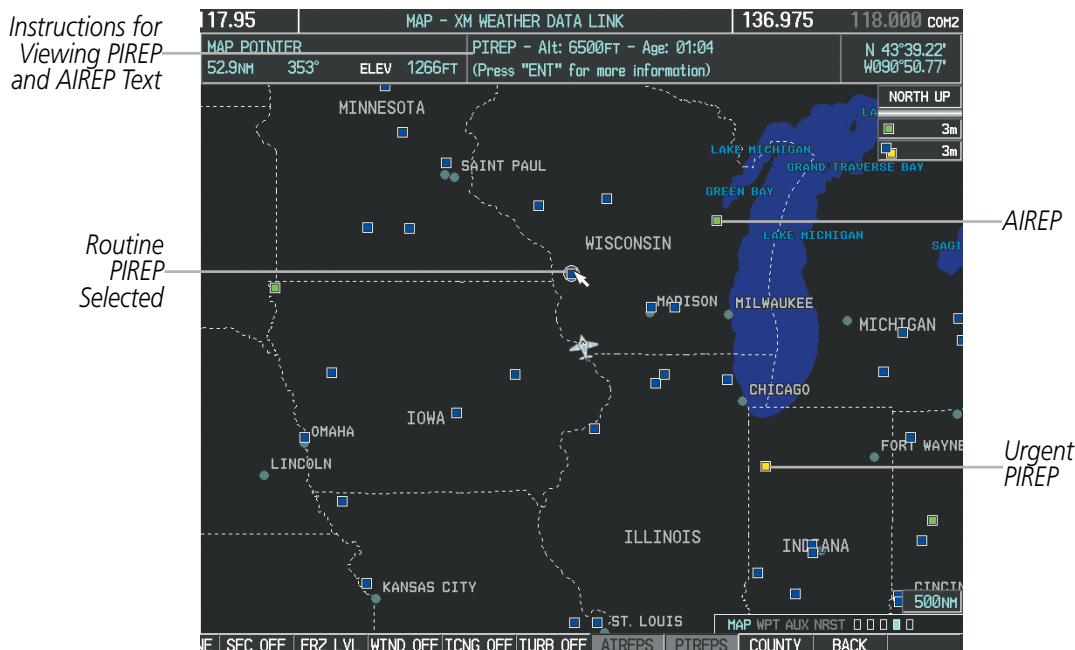

Figure 6-46 AIREPs and PIREPs on the XM Weather Data Link Page

### Displaying PIREP and AIREP text:

- 1) Select the XM Weather Data Link Page.
- 2) Press the **MORE WX** Softkey.
- 3) Press the **AIREPS** or **PIREPS** Softkey.
- 4) Press the **RANGE** Knob and pan to the desired weather report. A gray circle will appear around the weather report when it is selected.
- 5) Press the **ENT** Key. The Weather Information Page is shown with PIREP or AIREP text. The data is first displayed in a decoded fashion, then as raw text. Note the raw text may contain additional information not found in the decoded report.
- 6) Use the **FMS** Knob or the **ENT** Key to scroll through the PIREP or AIREP text.
- 7) Press the **FMS** Knob or the **CLR** Key to return to the XM Weather Data Link Page.



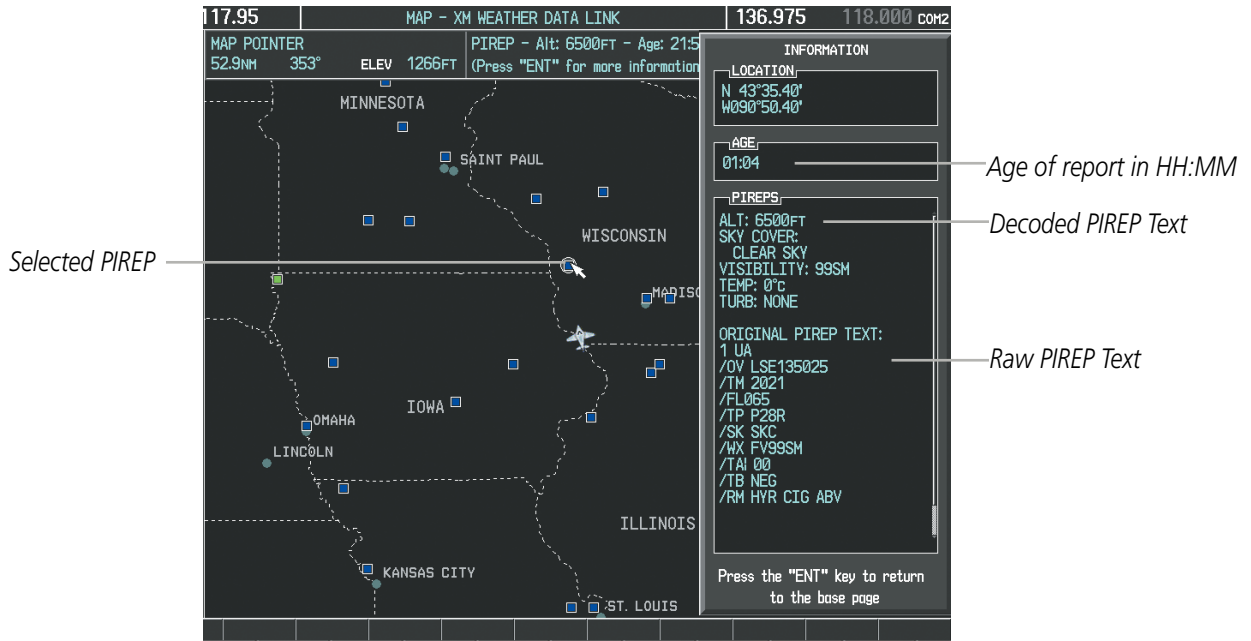

Figure 6-47 PIREP Text on the Weather Information Page

To display the PIREP or AIREP legend (Figure 6-48), press the **LEGEND** Softkey when PIREPs or AIREPs are displayed.

The PIREP color is determined by the type (routine or urgent).



Figure 6-48 AIREPs & PIREPs Legend

TFRS

The Federal Aviation Administration issues Temporary Flight Restrictions (TFRs) to designate areas where flight is restricted. TFRs are issued to restrict flight for a variety of reasons including national security, law enforcement, firefighting, natural disasters, airshows, and large sporting events. TFRs may be issued at any time, and TFR data displayed on the G1000 is only intended to supplement official TFR information obtained from official sources including Flight Service Stations (FSS), and air traffic control.

The age of TFR data is not shown; however, if TFR data is not available or has expired, the system displays 'TFR N/A' in the upper-left corner of maps on which TFRs can be displayed.

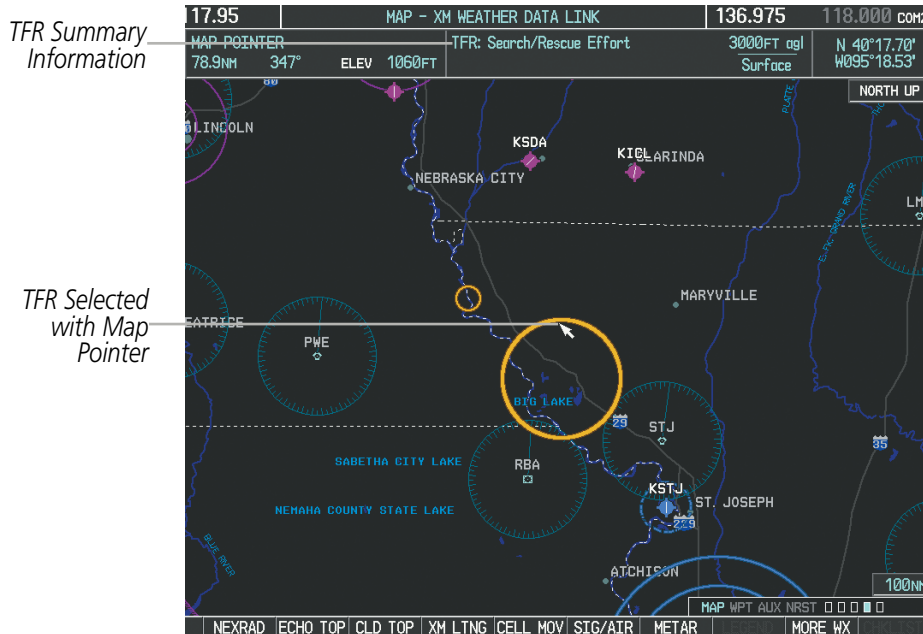

Figure 6-49 TFR Data on the XM Weather Data Link Page

Displaying TFR Data:

- 1) Select the XM Weather Data Link Page or Navigation Map Page.
- 2) Press the **RANGE** Knob and pan the map pointer over a TFR to highlight it. The system displays TFR summary information above the map.
- 3) Press the **ENT** Key. The system displays a pop-up menu.
- 4) If necessary, turn the **FMS** Knob to select 'Review Airspaces' and press the **ENT** Key. The system displays the TFR Information window.
- 5) Press the **FMS** Knob or the **CLR** Key to remove the TFR Information window.

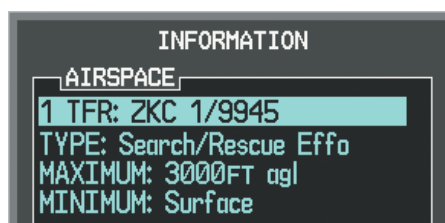

Figure 6-50 Full Text for Selected TFR

The setup menus for the Navigation Map Page control the map range settings above which TFR data is decluttered from the display. If a map range larger than the TFR product map range setting is selected, the TFR product data is removed from the map.

Maps other than the Navigation Map Page use settings based on those selected for the Navigation Map Page.

**Setting up and customizing TFR data for maps on which TFR data can be displayed:**

- 1) Select the Navigation Map Page.
- 2) Press the **MENU** Key.
- 3) With Map Setup highlighted, press the **ENT** Key (Figure 6-51).
- 4) Turn the small **FMS** Knob to select the Aviation Group and press the **ENT** Key (Figure 6-52).
- 5) Turn the large **FMS** Knob to scroll to the TFR product range setting (Figure 6-53).
- 6) Turn the small **FMS** Knob to scroll through options (Off, range settings).
- 7) Press the **ENT** Key to select an option.
- 8) Press the **FMS** Knob or **CLR** Key to return to the Navigation Map Page with the changed settings.

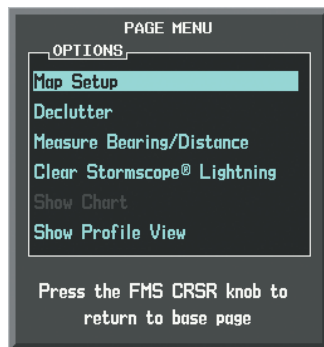

Figure 6-51 Navigation Map Page Menu



Figure 6-52 Navigation Map Page Setup Menu

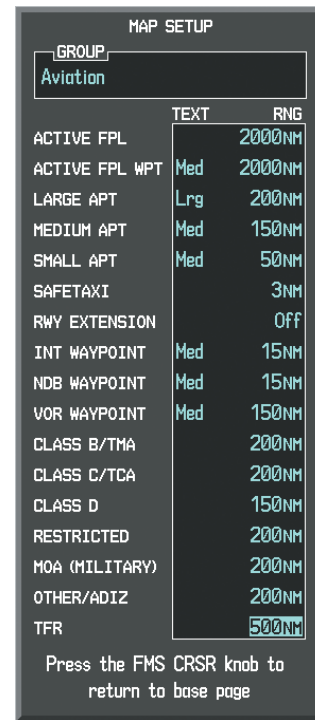

Figure 6-53 Navigation Map Page Setup Menu, Aviation Group

## 6.2 WX-500 STORMSCOPE



**NOTE:** The L-3 STORMSCOPE® WX-500 lightning detection system is not intended for hazardous thunderstorm penetration. Weather information on the G1000 MFD is approved for weather avoidance only. Refer to the WX-500 User's Guide for a detailed description of Stormscope operation.



**NOTE:** Stormscope lightning cannot be displayed at the same time as optional GDL 69/69A XM WX lightning data.

The following pages can display Stormscope data:

- Stormscope Page
- Navigation Map
- AUX - Trip Planning Page
- Nearest Pages

The Map - Stormscope Page is the principal page for viewing Stormscope data. Stormscope data can be displayed on other map pages as an additional reference. To display Stormscope data on the Navigation Map, AUX - Trip Planning Page, or any of the Nearest Pages, press the **MAP** Softkey, then press the **STRMSCP** Softkey. These pages can also display cell or strike data using the yellow lightning strike symbology shown in Table 6-4.





Lightning Age	Symbol
Strike is less than 6 seconds old	
Strike is between 6 and 60 seconds old	
Strike is between 1 and 2 minutes old	
Strike is between 2 and 3 minutes old	

Table 6-4 Lightning Age and Symbols

### SETTING UP STORMSCOPE ON THE NAVIGATION MAP

#### Setting up Stormscope options on the Navigation Map:

- 1) On the Navigation Map Page, press the **MENU** Key.
- 2) With 'Map Setup' selected (Figure 6-54), press the **ENT** Key.
- 3) Turn the small **FMS** Knob to display the group selection window. Turn the small **FMS** Knob to select 'Weather', and press the **ENT** Key.
- 4) Turn the large **FMS** Knob to highlight and move between the product selections (Figure 6-55).
- 5) When an item is highlighted, turn the small **FMS** Knob to select the option.
- 6) Press the **ENT** Key.
- 7) Press the **FMS** Knob to return to the Navigation Map Page (Figure 6-56).

The following options are available (Figure 6-55):

- **STRMSCP LTNG** – Turns the display of Stormscope data on or off.
- **STRMSCP MODE** – Selects the CELL or STRIKE mode of lightning activity. Cell mode identifies clusters or cells of electrical activity. Strike mode indicates the approximate location of lightning strikes.
- **STRMSCP SMBL** – Selects the range at which Stormscope data displays. Stormscope data is removed when a map range greater than the STRMSCP SMBL value is selected.



Figure 6-54 Navigation Map Page Menu

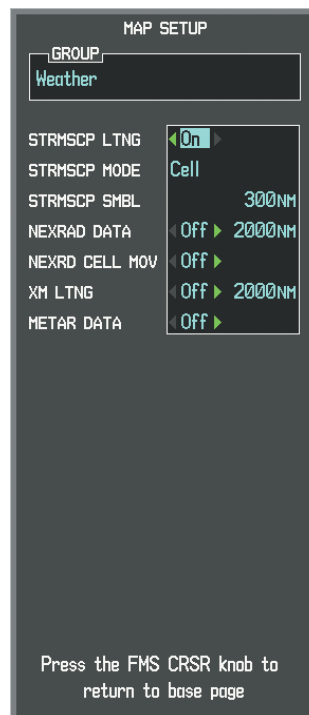

Figure 6-55 Map Setup Menu

## CELL AND STRIKE MODE ON THE NAVIGATION MAP

On the Navigation Map, cell mode identifies cells of lightning activity (Figure 6-56). Stormscope identifies clusters of electrical activity that indicate cells. Strike mode indicates the approximate location of lightning strikes.

### Selecting the 'cell' or 'strike' mode on the Navigation Map:

- 1) Press the **MENU** Key.
- 2) With 'Map Setup' selected, press the **ENT** Key.
- 3) Select the 'Weather' group.
- 4) Press the **ENT** Key. The cursor flashes on 'STRMSCP LTNG'.
- 5) Turn the large **FMS** Knob to select 'STRMSCP MODE'.
- 6) Turn the small **FMS** Knob to change between 'CELL' and 'STRIKE' options. When an item is selected, press the **ENT** Key.
- 7) Press the **FMS** knob to return to the Navigation Map Page.

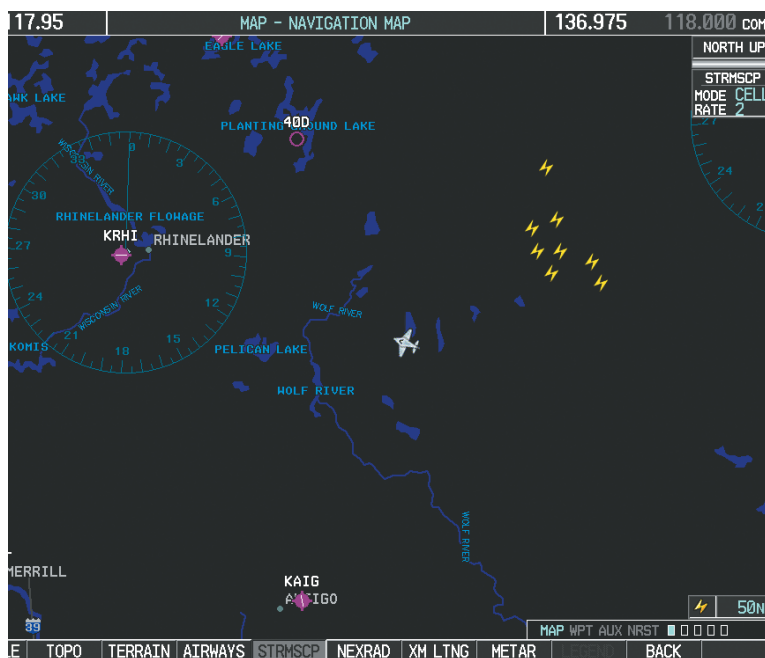

Figure 6-56 Navigation Map Page with Stormscope Lightning Data

If heading input is lost, strikes and/or cells must be cleared manually after the execution of each turn. This is to ensure that the strike and/or cell positions are depicted accurately in relation to the nose of the aircraft.

### Manually clearing Stormscope data on the Navigation Map:

- 1) Press the **MENU** Key.
- 2) Select 'Clear Stormscope® Lightning' (Figure 6-57).
- 3) Press the **ENT** Key.

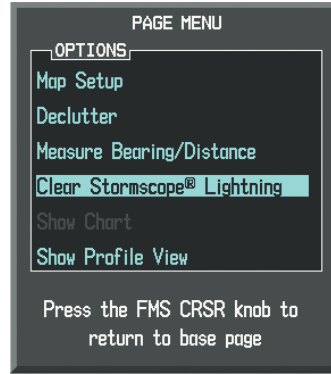

Figure 6-57 Navigation Map Page Options Menu

## ZOOM RANGE ON THE NAVIGATION MAP

Stormscope lightning data can be displayed up to 800 nm zoom range (in North up mode) on the Navigation Map Page. **However, in the track up mode at the 500 nm range, a portion of Stormscope lightning data can be behind the aircraft and therefore not visible on the Navigation Map.** Since the range for Stormscope data is 400 nm diameter total (200 nm in front and 200 nm behind), the 500 nm range in North up mode shows all the data.

At a map range of less than 25 nm, Stormscope lightning data is not displayed, but can still be present. The presence of Stormscope lightning data is indicated by the annunciation 'LTNG < 25 nm' in the upper right corner (Figure 6-58).

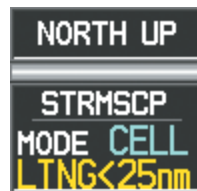

Figure 6-58 Lightning Display Range Annunciation

### Selecting a Stormscope range on the Navigation Map:

- 1) Press the **MENU** Key.
- 2) Select 'MAP SETUP'.
- 3) Select the 'Weather' group.
- 4) Press the **ENT** Key.
- 5) Turn the large **FMS** Knob to select 'STRMSCP SMBL'.
- 6) Turn the small **FMS** Knob to select the maximum display range.
- 7) Press the **ENT** Key.
- 8) Press the **FMS** Knob to return to the Navigation Map Page.



To change the display range on the Navigation Map Page, turn the **RANGE** Knob clockwise to zoom out or counter-clockwise to zoom in.

## SELECTING THE STORMSCOPE PAGE

Stormscope lightning data can be displayed at the ranges of 25 nm, 50 nm, 100 nm, and 200 nm.

### Adjusting the Stormscope Map Range:

- 1) Turn the large **FMS** Knob to select the Map Page Group.
- 2) Turn the small **FMS** Knob to select the Stormscope Page (Figure 6-59).
- 3) To change the map range, turn the **RANGE** Knob clockwise to zoom out or counter-clockwise to zoom in.

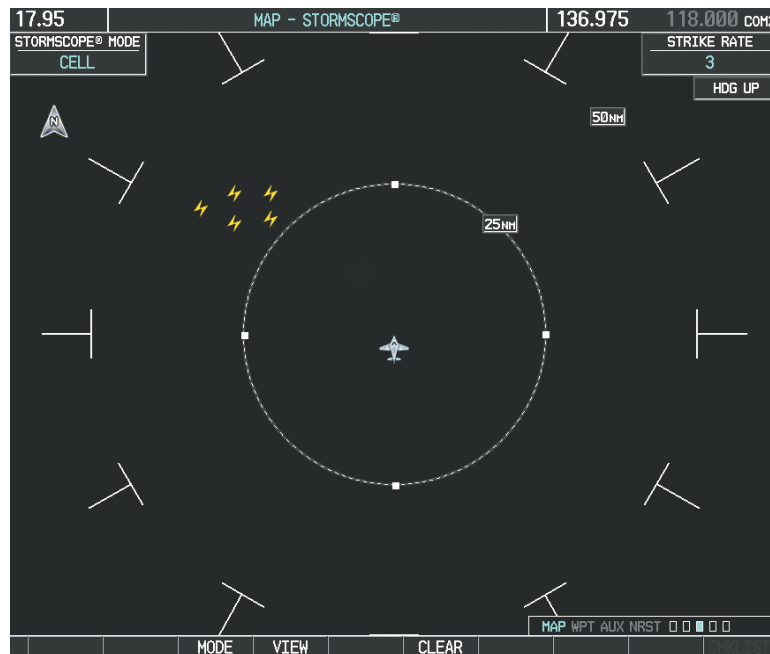

Figure 6-59 Stormscope Page

### Changing between 'cell' and 'strike' mode on the Stormscope Page:

- 1) Select the Stormscope Page.
- 2) Press the **MODE** Softkey. The **CELL** and **STRIKE** softkeys are displayed.
- 3) Press the **CELL** Softkey to display 'CELL' data or press the **STRIKE** Softkey to display 'STRIKE' data. 'CELL' or 'STRIKE' is displayed in the mode box in the upper left corner of the Stormscope Page.
- 4) Press the **BACK** Softkey to return to the main Stormscope page.

### Changing the viewing mode between 360° and 120° on the Stormscope Page:

- 1) Select the Stormscope Page.
- 2) Press the **VIEW** Softkey. The **360** and **ARC** softkeys are displayed. Press the **360** Softkey to display a 360° viewing area or press the **ARC** Softkey to display a 120° viewing area.
- 3) Press the **BACK** Softkey to return to the main Stormscope page.

## 6.3 TERRAIN PROXIMITY



**WARNING:** Do not use Terrain Proximity information for primary terrain avoidance. Terrain Proximity is intended only to enhance situational awareness.



**NOTE:** Terrain data is not displayed when the aircraft is outside of the installed terrain database coverage area.

G1000 Terrain Proximity is a terrain awareness system that does not comply with TSO-C151b certification standards. It increases situational awareness and aids in reducing controlled flight into terrain (CFIT). Do not confuse Terrain Proximity with a Terrain Awareness and Warning System (TAWS). TAWS is more sophisticated and robust, and it is TSO-C151b certified. Terrain Proximity does not provide warning annunciations or voice alerts. It only provides color indications on map displays when terrain and obstacles are within a certain altitude threshold from the aircraft. Although the terrain and obstacle color map displays are the same, TAWS uses more sophisticated algorithms to assess aircraft distance from terrain and obstacles.

Terrain Proximity requires the following components to operate properly:

- Valid 3-D GPS position
- Valid terrain/obstacle database

Terrain Proximity displays altitudes of terrain and obstructions relative to the aircraft position and altitude with reference to a database that may contain inaccuracies. Terrain and obstructions are shown only if they are in the database. Terrain and obstacle information should be used as an aid to situational awareness. They should never be used to navigate or maneuver around terrain.

Note that all obstructions may not be available in the terrain and obstacle database. No terrain and obstacle information is shown without a valid 3-D GPS position.

The G1000 GPS receiver provides the horizontal position and altitude. GPS altitude is derived from satellite position. GPS altitude is then converted to a mean sea level (MSL)-based altitude (GPS-MSL altitude) and is used to determine terrain and obstacle proximity. GPS-MSL altitude accuracy is affected by satellite geometry, but is not subject to variations in pressure and temperature that normally affect pressure altitude sensors. GPS-MSL altitude does not require local altimeter settings to determine MSL altitude. It is a widely-used MSL altitude source.

Terrain and obstacle databases are referenced to MSL. Using the GPS position and altitude, the Terrain Proximity feature portrays a 2-D picture of the surrounding terrain and obstacles relative to the position and altitude of the aircraft. GPS position and GPS-MSL altitude are used to calculate and predict the aircraft's flight path in relation to the surrounding terrain and obstacles. In this way, the pilot can view predicted dangerous terrain and obstacle conditions.

### DISPLAYING TERRAIN PROXIMITY DATA

The Map - Terrain Proximity Page is the principal page for viewing terrain and obstacle information. The symbols and colors in the figure and table below are used to represent obstacles and aircraft altitude when the Terrain Proximity Page is selected for display. Terrain Proximity uses black, yellow, and red to represent terrain information relative to aircraft altitude. The color of each obstacle is associated with the altitude of the aircraft.

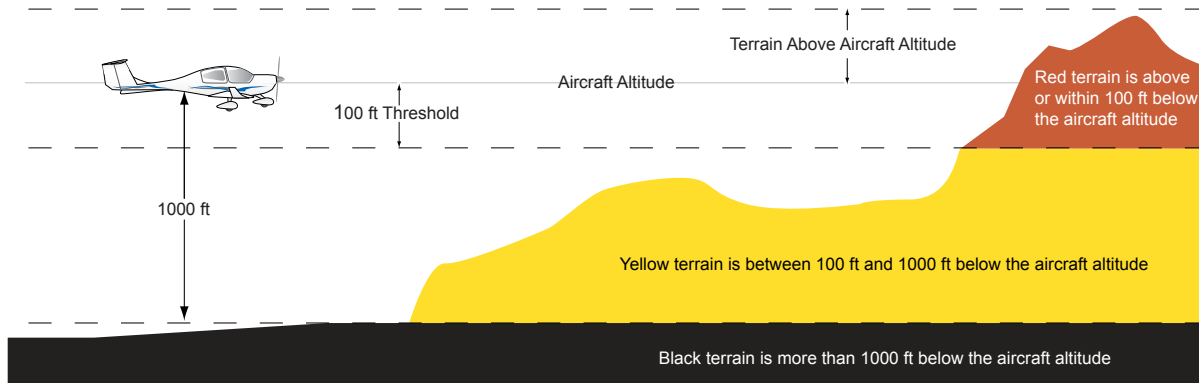

Figure 6-60 Terrain Altitude/Color Correlation for Terrain Proximity

Unlighted Obstacle		Lighted Obstacle		Obstacle Location
< 1000' AGL	> 1000' AGL	< 1000' AGL	> 1000' AGL	
				Red obstacle is above or within 100 ft below the aircraft altitude
				Yellow obstacle is between 100 ft and 1000 ft below the aircraft altitude

Table 6-5 Terrain Proximity Terrain/Obstacle Colors and Symbology

Terrain and obstacle information can be displayed on the following pages:

- PFD Inset Map
- Navigation Map Page
- Terrain Proximity Page
- Trip Planning Page
- Flight Plan Page
- Aux - Video Page

**Displaying terrain and obstacle information (maps other than the Terrain Proximity Page):**

- 1) Press the **MAP** Softkey (for the PFD Inset Map, press the **INSET** Softkey).
- 2) Press the **TERRAIN** Softkey to display terrain and obstacle data.

When Terrain Proximity is selected on maps other than the Terrain Proximity Page, an icon to indicate the feature is enabled for display and a legend for Terrain Proximity colors are shown (Figure 6-64).

The Navigation Map Page Setup Menu provides a means in addition to the softkey for enabling/disabling display of terrain and obstacles. The setup menu also controls the map range settings above which terrain and obstacle data are decluttered from the display. If a map range larger than the map range setting is selected, the data is removed from the map.

Terrain data can be selected for display independently of obstacle data; however, obstacles recognized by Terrain Proximity as yellow or red are shown when terrain is selected for display and the map range is within the setting limit.

Maps besides the Terrain Proximity Page use settings based on those selected for the Navigation Map Page. The maximum display ranges for obstacles on each map are dependent on the range setting made for the Navigation Map. If the maximum range for obstacle display on the Navigation Map is adjusted to below 20 nm, the highest obstacle display range settings on the other applicable maps are also adjusted proportionally.

**Customizing terrain and obstacle display on the Navigation Map Page:**

- 1) Select the Navigation Map Page.
- 2) Press the **MENU** Key.
- 3) With 'Map Setup' highlighted, press the **ENT** Key (Figure 6-61).
- 4) Turn the small **FMS** Knob to select the 'Map' Group and press the **ENT** Key (Figure 6-62).
- 5) Turn the large **FMS** Knob or press the **ENT** Key to scroll through product selections (Figure 6-63).
  - TERRAIN DATA – Turns the display of terrain data on or off and sets maximum range at which terrain is shown
  - OBSTACLE DATA – Turns the display of obstacle data on or off and sets maximum range at which obstacles are shown
- 6) Turn the small **FMS** Knob to scroll through options for each product (ON/OFF, range settings).
- 7) Press the **ENT** Key to select an option.
- 8) Press the **FMS** Knob or **CLR** Key to return to the Navigation Map Page with the changed settings.

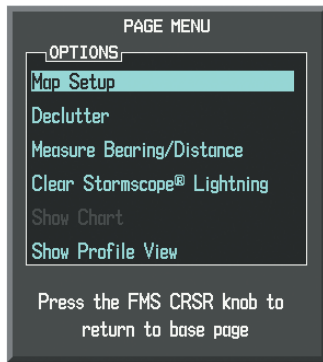

Figure 6-61 Navigation Map Page Menu



Figure 6-62 Navigation Map Page Setup Menu

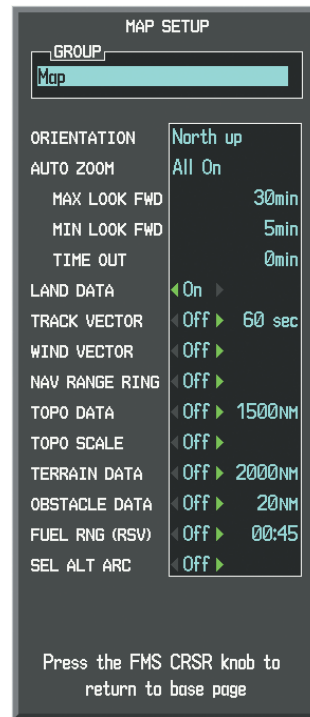

Figure 6-63 Navigation Map Page Setup Menu, Map Group

Additional information about obstacles can be displayed by panning over the display on the map. The map panning feature is enabled by pressing the **RANGE** Knob. The map range is adjusted by turning the **RANGE** Knob. If the map range is adjusted while panning is enabled, the map is re-centered on the Map Pointer.

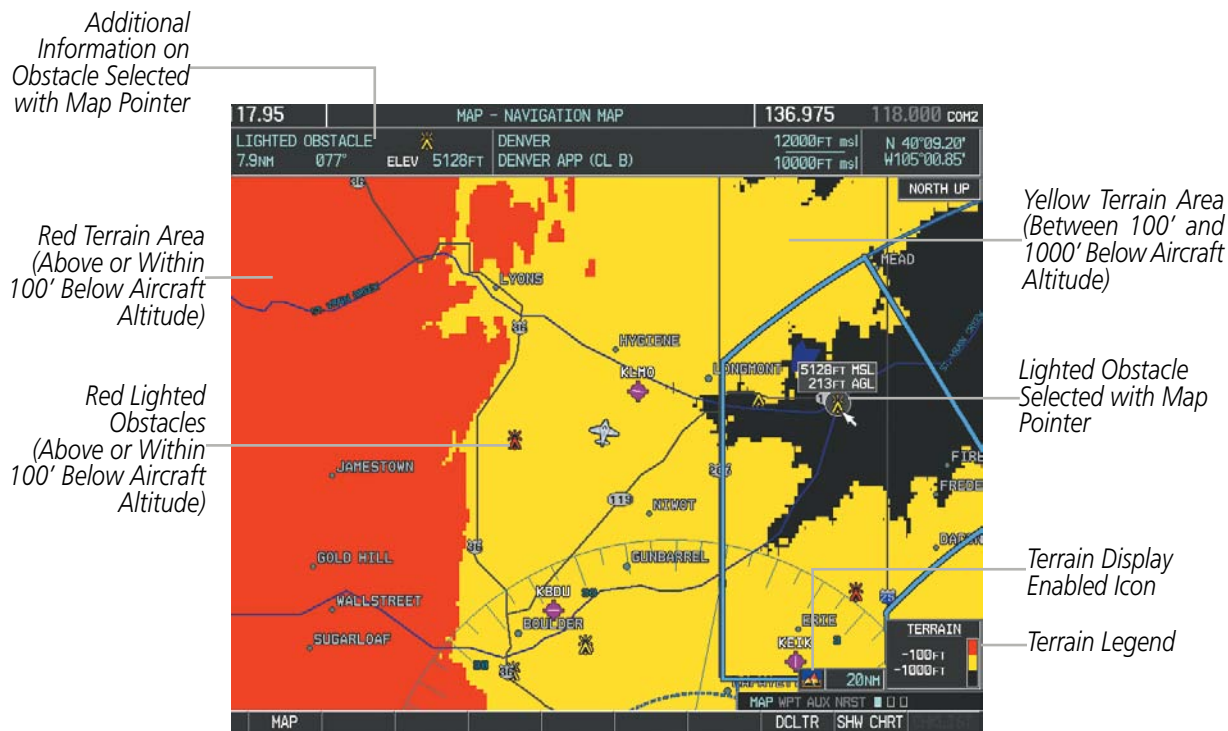

Figure 6-64 Terrain Information on the Navigation Map Page

## TERRAIN PROXIMITY PAGE

The Terrain Proximity Page is specialized to show terrain and obstacle data in relation to the aircraft's current altitude, without clutter from the basemap. It is the principal page for viewing Terrain Proximity information. Aviation data (airports, VORs, and other NAVAIDs) can be displayed for reference.

Aircraft orientation on this map is heading up unless there is no valid heading. Two views are available relative to the position of the aircraft: the 360° default display and the radar-like ARC (120°) display. Map range is adjustable with the **RANGE** Knob from 1 to 200 nm, as indicated by the map range rings (or arcs).

### Displaying the Terrain Proximity Page:

- 1) Turn the large **FMS** Knob to select the Map Page Group.
- 2) Turn the small **FMS** Knob to select the Terrain Proximity Page.
- 3) To change the view,
  - a) Press the **VIEW** Softkey.
  - b) Press the **360** or **ARC** Softkey to select the desired view.

Or:

  - a) Press the **MENU** Key.
  - b) Select 'View Arc' or 'View 360°' (choice dependent on current state) and press the **ENT** Key to change the view.



**Showing/hiding aviation information on the Terrain Proximity Page:**

- 1) Press the **MENU** Key.
- 2) Select 'Show Aviation Data' or 'Hide Aviation Data' (choice dependent on current state) and press the **ENT** Key.

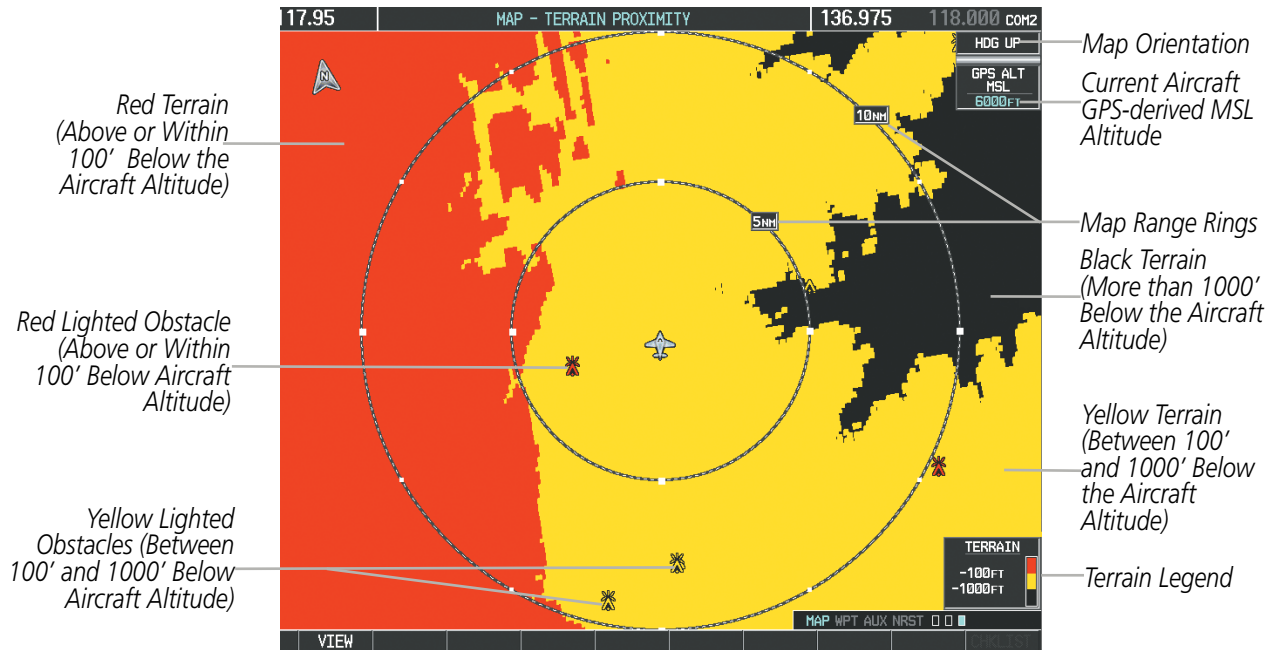

**Figure 6-65 Terrain Proximity Page**

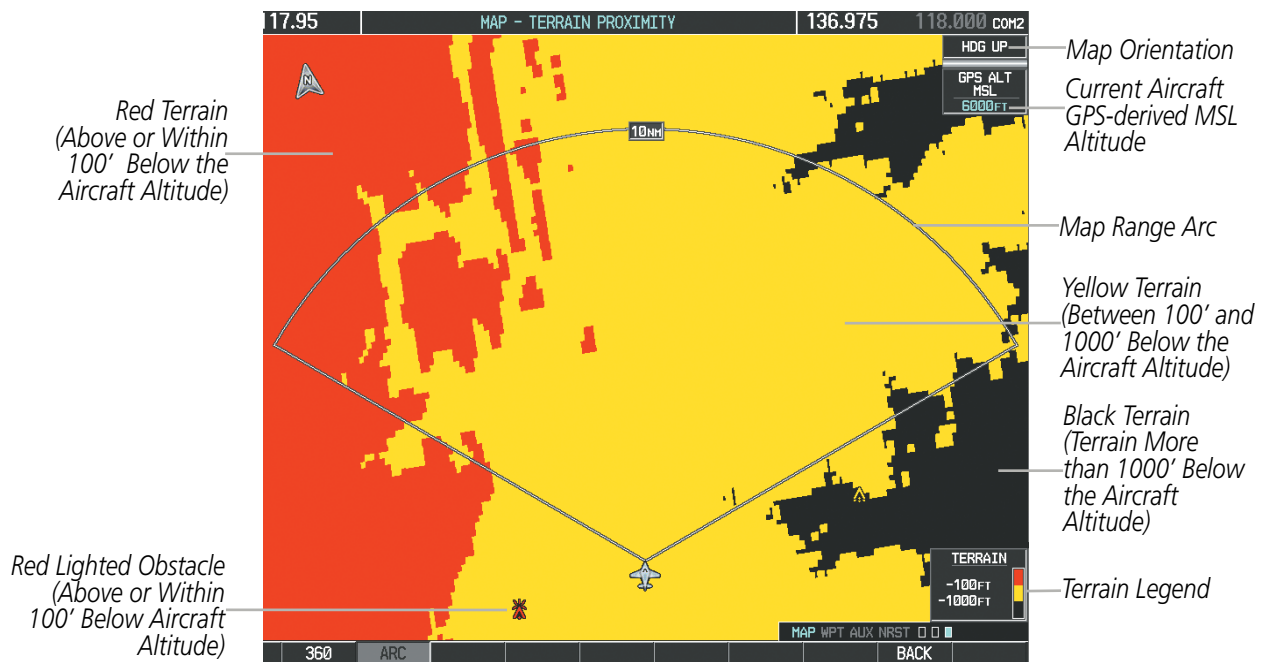

**Figure 6-66 Terrain Proximity Page (ARC View)**

## 6.4 PROFILE VIEW TERRAIN

**WARNING:** Do not use Profile View Terrain data for primary terrain avoidance. Profile View Terrain is intended only to enhance situational awareness.

**NOTE:** Terrain data is not displayed when the aircraft is outside of the installed terrain database coverage area.

The G1000 offers a Profile View of terrain and obstacles relative to the aircraft's current flight path and altitude on the Navigation Map Page of the MFD. Profile View does not provide terrain or obstacle caution or warning annunciations or voice alerts, nor does it display potential impact points inside the Profile View. The colors and symbols in Figure 6-67 and Table 6-6 are used to represent terrain and obstacles.

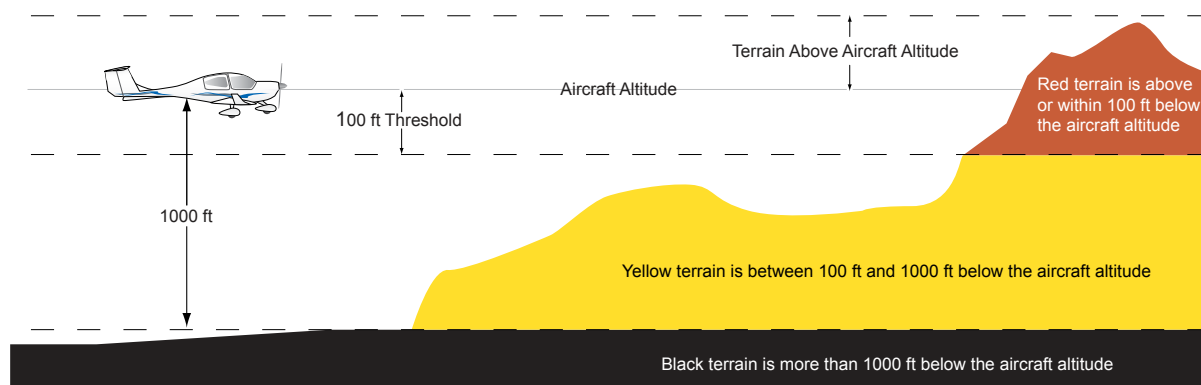

Figure 6-67 Terrain Altitude/Color Correlation for Profile View Terrain

Unlighted Obstacle		Lighted Obstacle		Obstacle Location
< 1000' AGL	> 1000' AGL	< 1000' AGL	> 1000' AGL	
				Red obstacle is above or within 100 ft below the aircraft altitude
				Yellow obstacle is between 100 ft and 1000 ft below the aircraft altitude

Table 6-6 Profile View Terrain/Obstacle Colors and Symbology

### Accessing Profile View:

- 1) Select the Navigation Map Page.
- 2) Press the **MAP** Softkey.
- 3) Press the **PROFILE** Softkey to enable or disable Profile View.



Or:

- 1) Press the **MENU** Key.
- 2) Select 'Show Profile View' or 'Hide Profile View' (choice dependent on current state) and press the **ENT** Key.

**Enabling/Disabling Profile View Terrain on the Navigation Map (when Profile View is enabled):**

- 1) Select the Navigation Map Page.
- 2) Press the **MAP** Softkey.
- 3) Press the **TERRAIN** Softkey.

**PROFILE VIEW DISPLAY**

When the Profile View is enabled, it is displayed in a window below the Navigation Map. Altitude is shown along a vertical scale, with an aircraft icon positioned at the current altitude. Distance is represented horizontally along the bottom of the Profile View, and increases from left (present position) to right.

When the Navigation Map range is adjusted with the **RANGE** Knob, the horizontal distance of the Profile View is adjusted proportionately to be 1/2 of the Navigation Map range distance down to 1 nm, at which point Profile View is no longer available ('PROFILE NOT AVAILABLE' is displayed). When Navigation Map range is adjusted to remove altitude-correlated colored terrain data (as shown in the Terrain Legend) or obstacles from the Navigation Map, these items are also removed from the Profile View; only an outline of the terrain will be displayed in black in the Profile View window. Refer to the Terrain Proximity or Terrain-SVS discussions for more information about displaying terrain or obstacles on the Navigation Map Page.

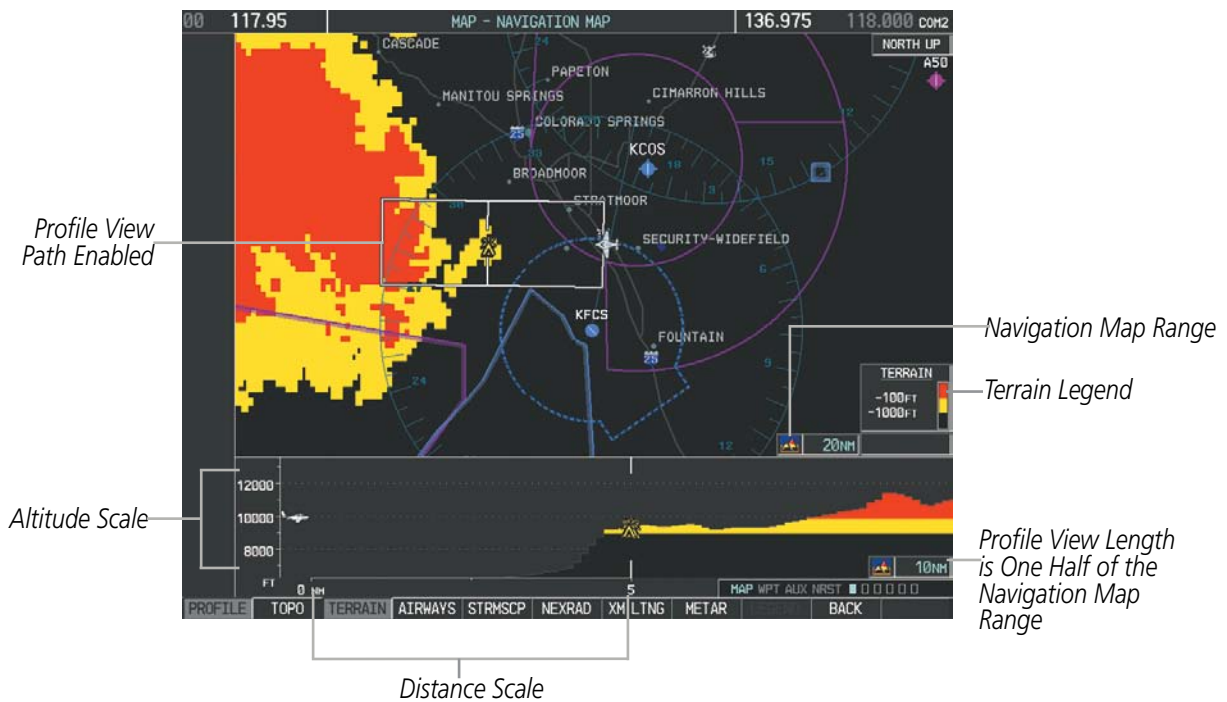

**Figure 6-68 Profile View on Navigation Map with Terrain Display Enabled**

The Profile View is based on the current aircraft track (or heading if track is unavailable) and shows the *highest* known terrain or obstacles within a predetermined width from the present aircraft position to the end of the profile range. The width of the Profile View (Table 6-7) is determined by the phase of flight, as announced on the HSI. Refer to the Flight Instruments section for more information about flight phases.

Flight Phase	Total Profile View Width
Approach	0.6 nm
Departure	0.6 nm
Terminal	2.0 nm
Enroute	4.0 nm
Oceanic	4.0 nm

Table 6-7 Profile View Width Scale

## PROFILE PATH

The Profile Path displays the horizontal and lateral boundaries of the Profile View. The path is shown as a white rectangle on the Navigation Map Page (Figure 6-68) and is only available when Profile View is enabled. White range markers both edges of the Profile Path rectangle match the range markers along the distance scale inside the Profile View display window whenever the profile range is at least 4 nm (or 7.5 km if configured for metric units).

The Profile Path rectangle may be configured on or off, and the Navigation Map range at which the Profile Path is removed from map display can be changed.

### Customizing the Profile Path display on the Navigation Map Page:

- 1) Select the Navigation Map Page.
- 2) Press the **MENU** Key.
- 3) With 'Map Setup' highlighted, press the **ENT** Key (Figure 6-69).
- 4) Turn the small **FMS** Knob to select the 'Profile' Group and press the **ENT** Key (Figure 6-70).
- 5) Turn the large **FMS** Knob or press the **ENT** Key to scroll through product selections (Figure 6-71).
  - PROFILE PATH – Turns the display of the Profile Path on or off and sets maximum map range at which the Profile Path is shown
- 6) Turn the small **FMS** Knob to scroll through options (ON/OFF, range settings).
- 7) Press the **ENT** Key to select an option.
- 8) Press the **FMS** Knob or **CLR** Key to return to the Navigation Map Page with the changed settings.

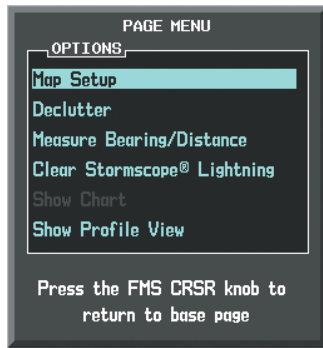

Figure 6-69 Navigation Map Page Menu

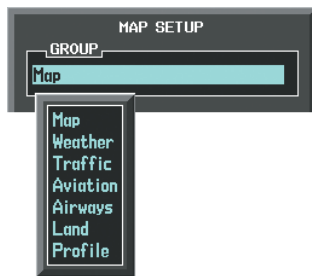

Figure 6-70 Navigation Map Page Setup Menu

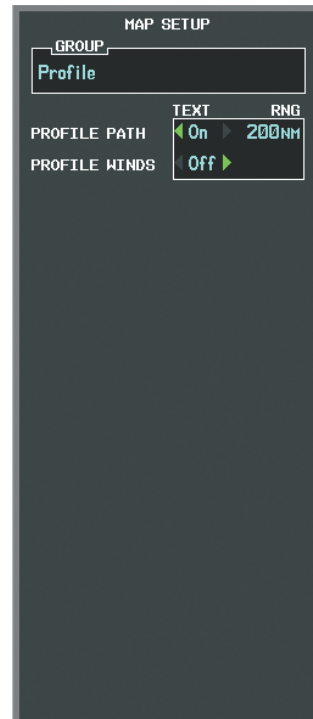

Figure 6-71 Navigation Map Page Setup Menu, Profile Group

## 6.5 TERRAIN-SVS



**WARNING:** Do not use Terrain-SVS information for primary terrain avoidance. Terrain-SVS is intended only to enhance situational awareness.



**NOTE:** Terrain data is not displayed when the aircraft is outside of the installed terrain database coverage area.

G1000 Terrain-SVS is a terrain awareness system available with the Synthetic Vision System (SVS). SVS functionality is offered as an optional enhancement. Terrain-SVS is integrated within SVS to provide visual and auditory alerts to indicate the presence of threatening terrain relevant to the projected flight path. For detailed information regarding SVS, refer to the Additional Features section.

Terrain-SVS does not comply with TSO-C151b certification standards. It increases situational awareness and aids in reducing controlled flight into terrain (CFIT). Do not confuse Terrain-SVS with Terrain Awareness and Warning System (TAWS). TAWS is more sophisticated and robust, and it is TSO-C151b certified. Although the terrain and obstacle color map displays are the same, TAWS uses more sophisticated algorithms to assess aircraft distance from terrain and obstacles.

Terrain-SVS does not provide the following:

- Premature Descent Alerting (PDA)
- Excessive Descent Rate (EDR)
- Negative Climb Rate (NCR)
- Descent to 500 Feet Callout (DFC)

Terrain-SVS requires the following components to operate properly:

- Valid 3-D GPS position
- Valid terrain/obstacle database

Terrain-SVS displays altitudes of terrain and obstructions relative to the aircraft position and altitude with reference to a database that may contain inaccuracies. Terrain and obstructions are shown only if they are in the database. Terrain and obstacle information should be used as an aid to situational awareness. They should never be used to navigate or maneuver around terrain.

Note that all obstructions may not be available in the terrain and obstacle database. No terrain and obstacle information is shown without a valid 3-D GPS position.

The G1000 GPS receiver provides the horizontal position and altitude. GPS altitude is derived from satellite position. GPS altitude is then converted to a mean sea level (MSL)-based altitude (GPS-MSL altitude) and is used to determine terrain and obstacle proximity. GPS-MSL altitude accuracy is affected by satellite geometry, but is not subject to variations in pressure and temperature that normally affect pressure altitude sensors. GPS-MSL altitude does not require local altimeter settings to determine MSL altitude. It is a widely-used MSL altitude source.

Terrain and obstacle databases are referenced to MSL. Using the GPS position and altitude, the Terrain-SVS feature portrays a 3-D picture of the surrounding terrain and obstacles relative to the position and altitude of the aircraft. GPS position and GPS-MSL altitude are used to calculate and predict the aircraft's flight path in relation

to the surrounding terrain and obstacles. In this way, the pilot can view predicted dangerous terrain and obstacle conditions.

**DISPLAYING TERRAIN-SVS DATA**

Terrain-SVS uses yellow (caution) and red (warning) to depict terrain and obstacles (with heights greater than 200 feet above ground level, AGL) alerts relative to aircraft altitude. Colors are adjusted automatically as the aircraft altitude changes. The colors and symbols in the figure and tables below are used to represent terrain, obstacles, and potential impact points.

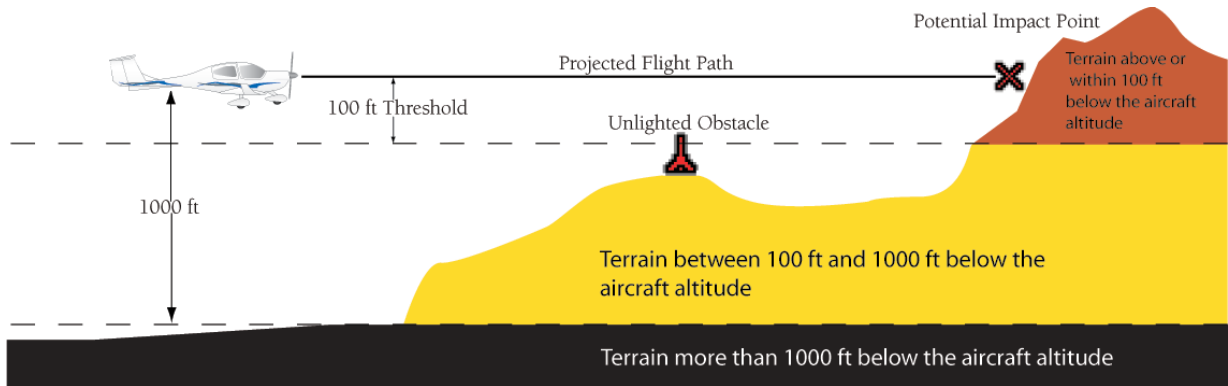

Figure 6-72 Terrain Altitude/Color Correlation for Terrain-SVS

Unlighted Obstacle		Lighted Obstacle		Obstacle Location
< 1000' AGL	> 1000' AGL	< 1000' AGL	> 1000' AGL	
				Red obstacle is above or within 100 ft below the aircraft altitude
				Yellow obstacle is between 100 ft and 1000 ft below the aircraft altitude

Table 6-8 Terrain-SVS Obstacle Colors and Symbology

Potential Impact Point Symbol	Alert Type	Example Annunciation
	Warning	
	Caution	

Table 6-9 Terrain-SVS Potential Impact Point Symbols with Alert Types

The Map - Terrain-SVS Page is the principal page for viewing terrain and obstacle information. Terrain-SVS information can also be displayed on the following pages and maps as an additional reference:

- PFD Inset Map
- Trip Planning Page
- Navigation Map Page
- Flight Plan Pages

**Displaying terrain and obstacle information (maps other than the Terrain-SVS Page):**

- 1) Press the **MAP** Softkey (for the PFD Inset Map, select the **INSET** Softkey).
- 2) Press the **TERRAIN** Softkey to display terrain and obstacle data.

When Terrain-SVS is selected on maps other than the Terrain-SVS Page, an icon to indicate the feature is enabled for display and a legend for Terrain-SVS terrain colors are shown (Figure 6-73).

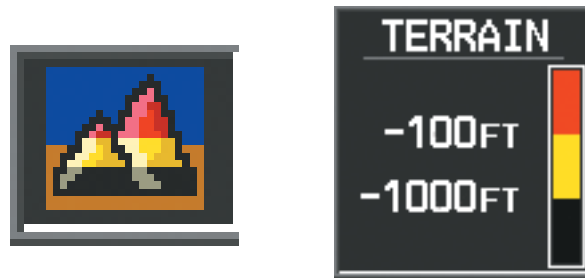

**Figure 6-73 Terrain-SVS Icon and Legend**

The Navigation Map Page Setup Menu provides a means in addition to the softkey for enabling/disabling display of terrain and obstacles. The setup menu also controls the map range settings above which terrain and obstacle data are decluttered from the display. If a map range larger than the map range setting is selected, the data is removed from the map. For terrain data, the enable/disable function applies only to the MFD, while the range setting also affects the PFD Inset Map.

Terrain data can be selected for display independently of obstacle data; however, obstacles for which warnings and cautions are issued are shown when terrain is selected for display and the map range is within the setting limit.

Maps besides the Terrain-SVS Page use settings based on those selected for the Navigation Map Page. The maximum display ranges for obstacles on each map are dependent on the range setting made for the Navigation Map. If the maximum range for obstacle display on the Navigation Map is adjusted to below 20 nm, the highest obstacle display range settings on the other applicable maps are also adjusted proportionally.

**Customizing terrain and obstacle display on the Navigation Map Page:**

- 1) Select the Navigation Map Page.
- 2) Press the **MENU** Key.
- 3) With 'Map Setup' highlighted, press the **ENT** Key (Figure 6-74).
- 4) Turn the small **FMS** Knob to select the 'Map' Group and press the **ENT** Key (Figure 6-75).
- 5) Turn the large **FMS** Knob or press the **ENT** Key to scroll through product selections (Figure 6-76).
  - TERRAIN DATA – Turns the display of terrain data on or off and sets maximum range at which terrain is shown
  - OBSTACLE DATA – Turns the display of obstacle data on or off and sets maximum range at which obstacles are shown
- 6) Turn the small **FMS** Knob to scroll through options for each product (ON/OFF, range settings).
- 7) Press the **ENT** Key to select an option.
- 8) Press the **FMS** Knob or **CLR** Key to return to the Navigation Map Page with the changed settings.

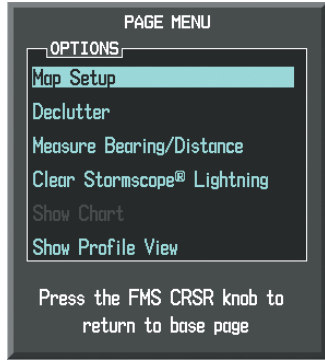

Figure 6-74 Navigation Map Page Menu

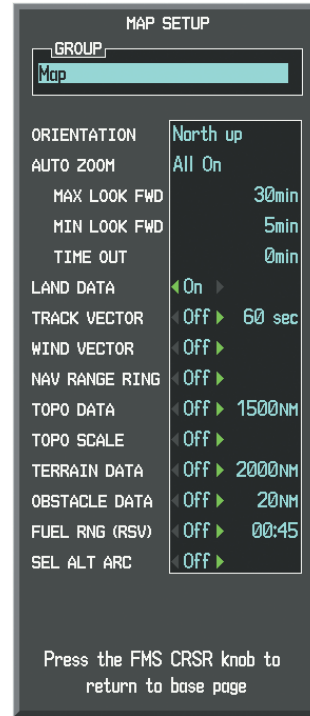

Figure 6-76 Navigation Map Page Setup Menu, Map Group

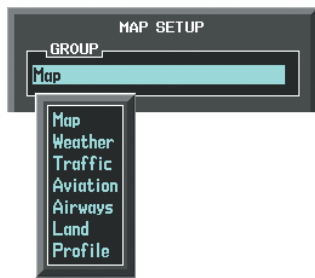

Figure 6-75 Navigation Map Page Setup Menu

## TERRAIN-SVS PAGE

The Terrain-SVS Page is specialized to show terrain, obstacle, and potential impact point data in relation to the aircraft's current altitude, without clutter from the basemap. It is the principal map page for viewing Terrain-SVS data. Aviation data (airports, VORs, and other NAVAIDs) can be displayed for reference. If an obstacle and the projected flight path of the aircraft intersect, the display automatically zooms in to the closest potential point of impact on the Terrain-SVS Page.

Aircraft orientation on this map is always heading up unless there is no valid heading. Two views are available relative to the position of the aircraft: the 360° default display and the radar-like ARC (120°) display. Map range is adjustable with the **RANGE** Knob from 1 to 200 nm, as indicated by the map range rings (or arcs).

### Displaying the Terrain-SVS Page:

- 1) Turn the large **FMS** Knob to select the Map Page Group.
- 2) Turn the small **FMS** Knob to select the Terrain-SVS Page.

### Changing the Terrain-SVS Page view:

- 1) Press the **VIEW** Softkey.
- 2) Press the **360** or **ARC** Softkey to select the desired view.

Or:

- 1) Press the **MENU** Key.
- 2) Select 'View Arc' or 'View 360°' (choice dependent on current state) and press the **ENT** Key to change the view



SYSTEM OVERVIEW

FLIGHT INSTRUMENTS

EIS

AUDIO PANEL & CNS

FLIGHT MANAGEMENT

HAZARD AVOIDANCE

AFCS

ADDITIONAL FEATURES

APPENDICES

INDEX

Showing/hiding aviation information on the Terrain-SVS Page:

- 1) Press the **MENU** Key.
- 2) Select 'Show Aviation Data' or 'Hide Aviation Data' (choice dependent on current state) and press the **ENT** Key.

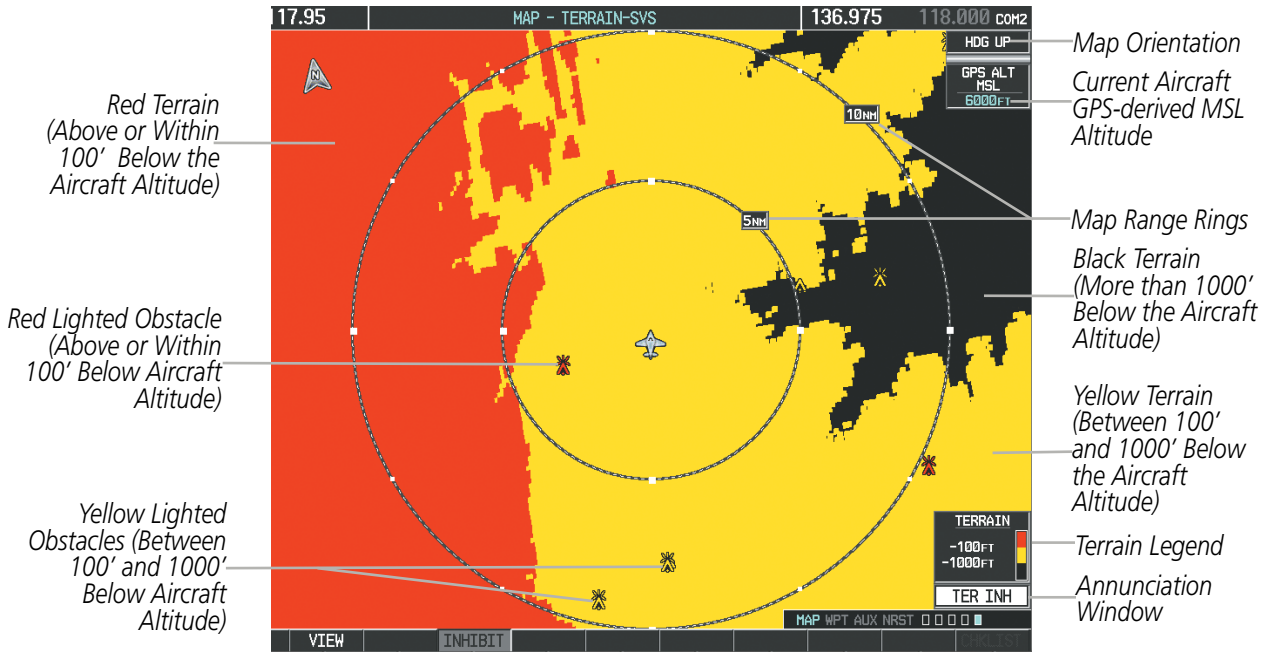

Figure 6-77 Terrain-SVS Page (360 View)

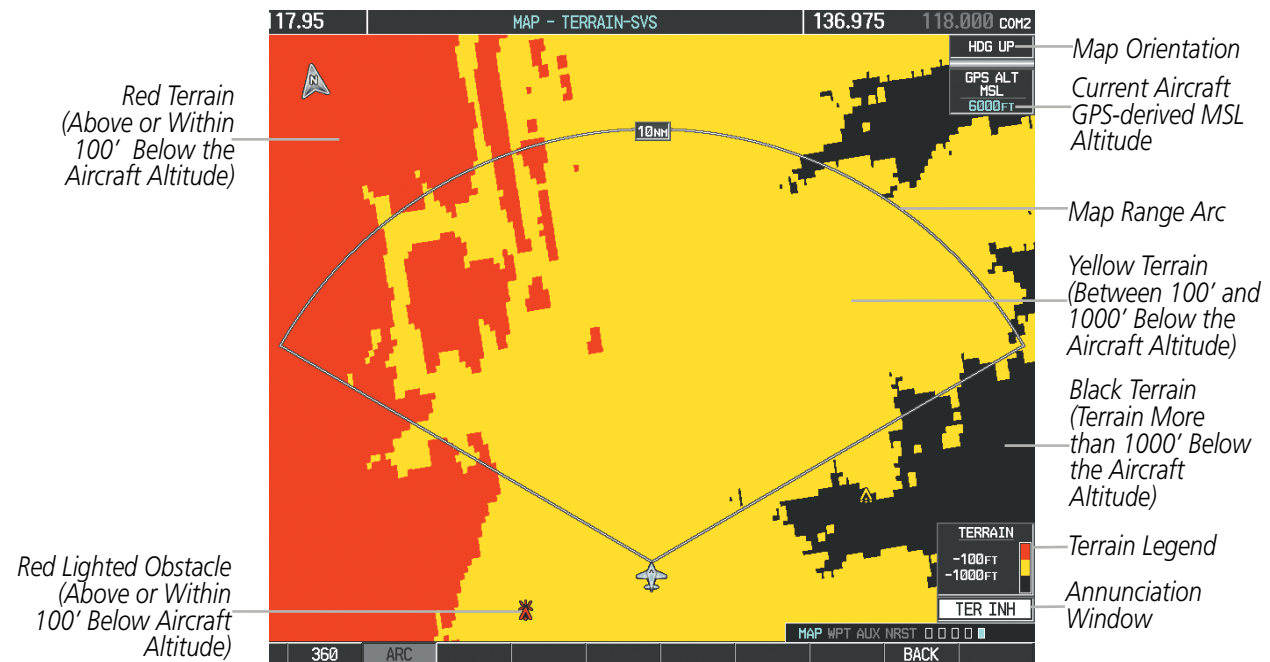

Figure 6-78 Terrain-SVS Page (ARC View)

### TERRAIN-SVS ALERTS

Alerts are issued when flight conditions meet parameters that are set within Terrain-SVS software algorithms. Terrain-SVS alerts typically employ a CAUTION or a WARNING alert severity level, or both. When an alert is issued, visual annunciations are displayed and aural alerts are simultaneously issued. Table 6-10 shows Terrain-SVS alert types with corresponding annunciations and aural messages.

When an alert is issued, annunciations appear on the PFD and MFD. The Terrain-SVS Alert Annunciation is shown to the upper left of the Altimeter on the PFD and below the Terrain Legend on the MFD. If the Terrain-SVS Page is not displayed at the time, a pop-up alert appears on the MFD. To acknowledge the pop-up alert:

- Press the **CLR** Key (returns to the currently viewed page), or
- Press the **ENT** Key (accesses the Terrain-SVS Page)

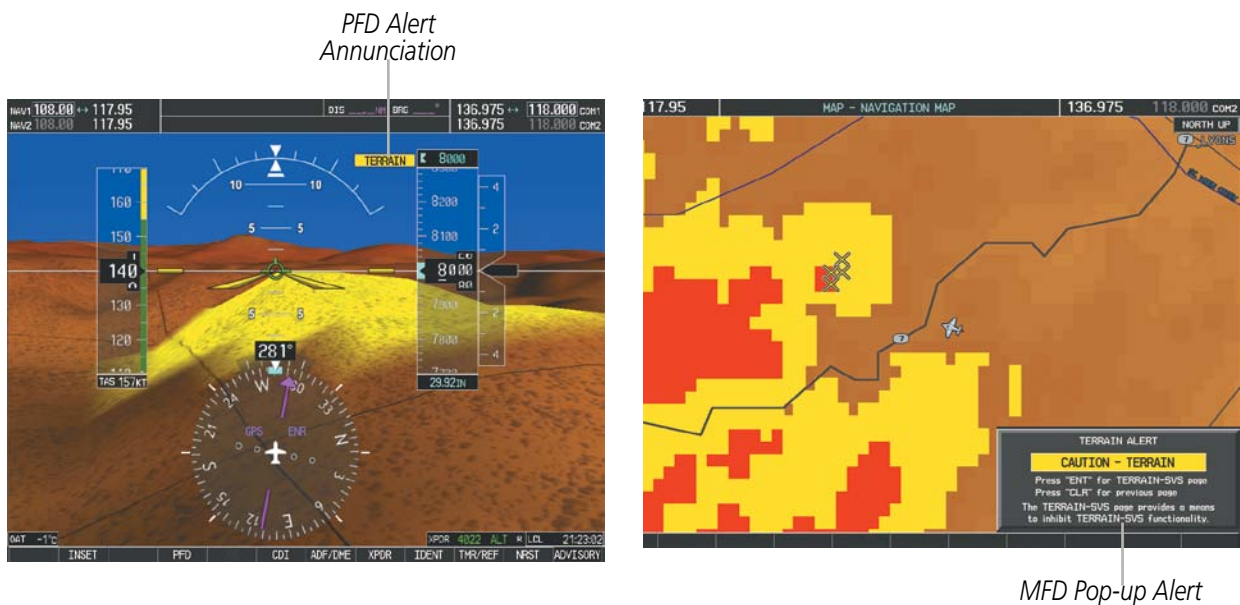

Figure 6-79 Terrain-SVS Alert Annunciations

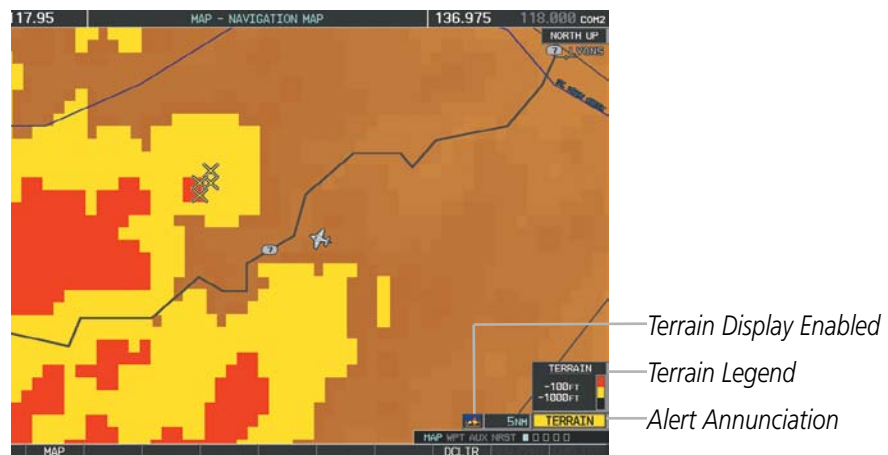

Figure 6-80 Navigation Map Page (After Terrain-SVS Pop-up Alert Acknowledgment)

SYSTEM OVERVIEW

FLIGHT INSTRUMENTS

EIS

AUDIO PANEL & CNS

FLIGHT MANAGEMENT

HAZARD AVOIDANCE

AFCS

ADDITIONAL FEATURES

APPENDICES

INDEX

Alert Type	PFD/MFD* Alert Annunciation	MFD Pop-Up Alert (except Terrain-SVS Page)	Aural Message
Reduced Required Terrain Clearance Warning (RTC)	TERRAIN	WARNING - TERRAIN	"Warning; Terrain, Terrain"
Imminent Terrain Impact Warning (ITI)	TERRAIN	WARNING - TERRAIN	"Warning; Terrain, Terrain"
Reduced Required Obstacle Clearance Warning (ROC)	TERRAIN	WARNING - OBSTACLE	"Warning; Obstacle, Obstacle"
Imminent Obstacle Impact Warning (IOI)	TERRAIN	WARNING - OBSTACLE	"Warning; Obstacle, Obstacle"
Reduced Required Terrain Clearance Caution (RTC)	TERRAIN	CAUTION - TERRAIN	"Caution; Terrain, Terrain"
Imminent Terrain Impact Caution (ITI)	TERRAIN	CAUTION - TERRAIN	"Caution; Terrain, Terrain"
Reduced Required Obstacle Clearance Caution (ROC)	TERRAIN	CAUTION - OBSTACLE	"Caution; Obstacle, Obstacle"
Imminent Obstacle Impact Caution (IOI)	TERRAIN	CAUTION - OBSTACLE	"Caution; Obstacle, Obstacle"

\* Annunciation is displayed on the MFD when terrain display is enabled.

Table 6-10 Terrain-SVS Alerts Summary

## FORWARD LOOKING TERRAIN AVOIDANCE

The Forward Looking Terrain Avoidance (FLTA) feature of Terrain-SVS compares the aircraft's projected flight path with known terrain and obstacles in their respective databases and issues four types of alerts.

**Reduced Required Terrain Clearance (RTC)** and **Reduced Required Obstacle Clearance (ROC)** alerts are issued when the aircraft flight path is above terrain, yet is projected to come within the minimum clearance values in Figure 6-81. When an RTC alert is issued, a potential impact point is displayed on the Terrain-SVS Page.

**Imminent Terrain Impact (ITI)** and **Imminent Obstacle Impact (IOI)** alerts are issued when the aircraft is below the elevation of a terrain or obstacle cell in the aircraft's projected path. ITI and IOI alerts are accompanied by a potential impact point displayed on the Terrain-SVS Page. The alert is annunciated when the projected vertical flight path is calculated to come within minimum clearance altitudes in Figure 6-81.

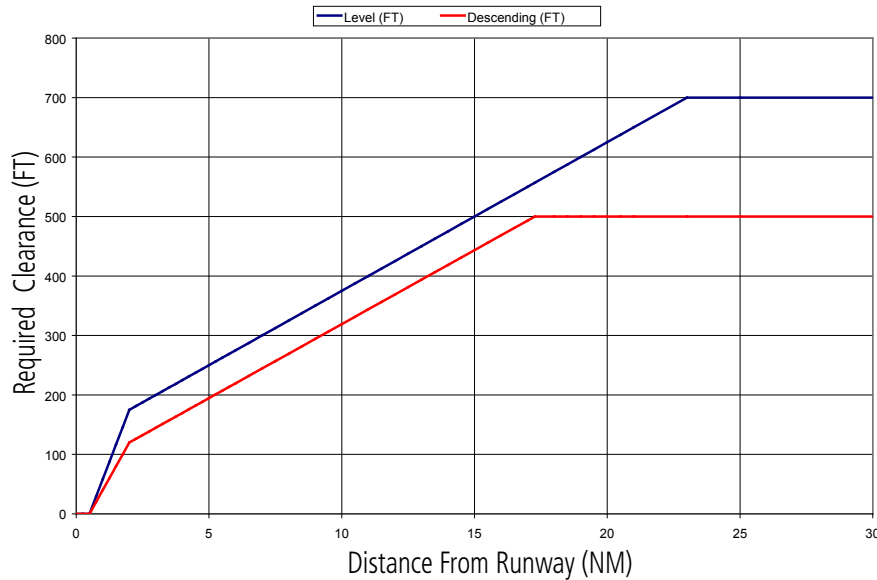

Figure 6-81 FLTA Alert Minimum Terrain and Obstacle Clearance Values

FLTA alerts are automatically inhibited when the aircraft is less than 200 feet above the destination runway elevation while within 0.5 nm of the approach runway or the aircraft is between runway ends. When Terrain-SVS alerts are inhibited, the annunciation 'TER INH' is shown on the PFD and in the MFD terrain annunciation window.

FLTA aural and visual alerts can also be manually inhibited. Discretion should be used when inhibiting Terrain-SVS and the system should be enabled when appropriate. When Terrain-SVS is inhibited, the alert annunciation 'TER INH' is shown on the PFD and MFD (Figure 6-82).

TER INH

Figure 6-82 Terrain-SVS Alerting Disabled (Terrain-SVS Inhibited) Annunciation

**Inhibiting/enabling Terrain-SVS alerting:**

- 1) Select the Terrain-SVS Page.
- 2) Press the **INHIBIT** Softkey to inhibit or enable Terrain-SVS (choice dependent on current state).

**Or:**

- a) Press the **MENU** Key.
- b) Select 'Inhibit Terrain-SVS' or 'Enable Terrain-SVS' (choice dependent on current state) and press the **ENT** Key.

If Terrain-SVS alerts are inhibited when the Final Approach Fix is the active waypoint on a GPS SBAS approach, a 'LOW ALT' annunciation may appear on the PFD next to the Altimeter if the current aircraft altitude is at least 164 feet below the prescribed altitude at the Final Approach Fix. See the Flight Instruments Section for details.

## SYSTEM STATUS

During power-up, Terrain-SVS conducts a self-test of its aural and visual annunciations. An aural alert is issued at test completion.

Terrain-SVS continually monitors several system-critical items such as database validity, hardware status, and GPS status. If the terrain/obstacle database is not available, the aural message **“Terrain System Failure”** is generated along with the ‘TER FAIL’ alert annunciation.

Terrain-SVS requires a 3-D GPS navigation solution along with specific vertical accuracy minimums. Should the navigation solution become degraded or if the aircraft is out of the database coverage area, the annunciation ‘TER N/A’ is generated in the annunciation window and on the Terrain-SVS Page. The aural message **“Terrain System Not Available”** is generated. When sufficient GPS signal is returns and the aircraft is within the database coverage area, the aural message **“Terrain System Available”** is generated.

Alert Type	PFD/MFD <sup>†</sup> Alert Annunciation	Terrain-SVS Page Center Banner Annunciation	Aural Message
System Test in Progress	TER TEST	<b>TERRAIN TEST</b>	None
System Test Pass	None	None	“Terrain System Test OK”
Terrain Alerting Inhibited	TER INH	None	None
No GPS position	TER N/A	<b>NO GPS POSITION</b>	“Terrain System Not Available”*
Excessively degraded GPS signal; or Out of database coverage area	TER N/A	None	“Terrain System Not Available”*
Terrain System Test Fail; Terrain or Obstacle database unavailable or invalid; Invalid software configuration; or System audio fault	TER FAIL	<b>TERRAIN FAIL</b>	“Terrain System Failure”
MFD Terrain or Obstacle database unavailable or invalid, and Terrain-SVS operating with PFD Terrain or Obstacle databases	None	<b>TERRAIN DATABASE FAILURE</b>	None

<sup>†</sup> Annunciation is shown on Terrain-SVS Page and the Navigation Map Page when Terrain is enabled.

\* “Terrain System Available” will be heard when sufficient GPS signal is received, or Terrain database coverage area re-entered.

Table 6-11 Terrain-SVS System Status Annunciations

## 6.6 TRAFFIC INFORMATION SERVICE (TIS)



**WARNING:** The Traffic Information Service (TIS) is intended for advisory use only. TIS is intended to help the pilot locate traffic visually. It is the responsibility of the pilot to see and maneuver to avoid traffic.



**NOTE:** TIS is available only when the aircraft is within the service volume of a TIS-capable terminal radar site. Aircraft without an operating transponder are invisible to both Traffic Advisory Systems (TAS) and TIS. Aircraft without altitude reporting capability are shown without altitude separation data or climb descent indication.



**NOTE:** TIS is disabled if a Traffic Advisory System (TAS) is installed.

Traffic Information Service (TIS) is designed to help in detection and avoidance of other aircraft. TIS uses the Mode S transponder for the traffic data link. TIS receives traffic information from ground stations, and is updated every 5 seconds. The G1000 displays up to eight traffic targets within a 7.5-nm radius, from 3000 feet below to 3500 feet above the requesting aircraft. Traffic is displayed using the symbology shown in Table 6-12.



TIS Symbol	Description
	Non-Threat Traffic
	Traffic Advisory (TA)
	Traffic Advisory Off Scale

Table 6-12 TIS Traffic Symbols

A Traffic Advisory (TA) indicates that the current track of the intruder could result in a collision. When traffic meets the advisory criteria for the TA, a solid yellow circle symbol is generated. A TA which is detected, but is outside the range of the map, is indicated with a message in the lower left corner of the map and a half TA symbol at the relative bearing of the intruder.

TIS also provides a vector line showing the direction in which the traffic is moving, to the nearest 45°. Traffic information for which TIS is unable to determine the bearing (non-bearing traffic) is displayed in the center of the Traffic Map Page (Figure 6-87) or in a banner at the lower left corner of maps other than the Traffic Map Page on which traffic can be displayed (Figure 6-83).



The altitude difference between the requesting aircraft and other intruder aircraft is displayed above/below the traffic symbol in hundreds of feet. If the other aircraft is above the requesting aircraft, the altitude separation appears above the traffic symbol; if below, the altitude separation appears below. Altitude trend is displayed as an up/down arrow (for speeds greater than 500 fpm in either direction) to the right of the target symbol. Traffic symbols for aircraft without altitude reporting capability appear without altitude separation or climb/descent information.

### DISPLAYING TRAFFIC DATA

The Map - Traffic Map Page is the principal page for viewing traffic information. Additional displays of traffic information are available as map overlays while TIS is operating, and serve as additional reference to the Traffic Map Page. Traffic information can be displayed on the following maps and pages:

- PFD Inset Map
- Nearest Pages
- Navigation Map Page
- Active Flight Plan Page
- Traffic Map Page
- AUX - Video Page
- Trip Planning Page

#### Displaying traffic information (maps other than the Traffic Map Page):

- 1) Press the **MAP** Softkey.
- 2) Press the **TRAFFIC** Softkey.

When traffic is selected on maps other than the Traffic Map Page, an icon is shown to indicate the feature is enabled for display.



Figure 6-83 TIS Traffic on the Navigation Map Page



**Displaying traffic information (PFD Inset Map):**

- 1) Press the **INSET** Softkey.
- 2) Press the **TRAFFIC** Softkey to display traffic data on the inset map (TRFC-1).
- 3) Press the softkey again to display the traffic-only inset (TRFC-2).
- 4) Press the softkey again to remove traffic data.

The Navigation Map Page Setup Menu provides a means in addition to the softkey for enabling/disabling display of traffic. The setup menu also controls the map range settings above which traffic data (symbols and labels) are decluttered from the display. If a map range larger than the map range setting is selected, the data is removed from the map. Maps besides the Traffic Map Page use settings based on those selected for the Navigation Map Page.

**Customizing traffic display on the Navigation Map Page:**

- 1) Select the Navigation Map Page.
- 2) Press the **MENU** Key.
- 3) With 'Map Setup' highlighted, press the **ENT** Key (Figure 6-84).
- 4) Turn the small **FMS** Knob to select the 'Traffic' Group and press the **ENT** Key (Figure 6-85).
- 5) Turn the large **FMS** Knob or press the **ENT** Key to scroll through product selections (Figure 6-86).
  - TRAFFIC – Turns the display of traffic data on or off
  - TRAFFIC MODE – Selects the traffic mode for display; select from:
    - All Traffic - Displays all traffic
    - TA/PA - Displays Traffic Alerts and Proximity Advisories
    - TA ONLY - Displays Traffic Alerts only
  - TRAFFIC SMBL – Selects the maximum range at which traffic symbols are shown
  - TRAFFIC LBL – Selects the maximum range at which traffic labels are shown (with the option to turn off)
- 6) Turn the small **FMS** Knob to scroll through options for each product (ON/OFF, range settings, etc.).
- 7) Press the **ENT** Key to select an option.
- 8) Press the **FMS** Knob or **CLR** Key to return to the Navigation Map Page with the changed settings.



Figure 6-84 Navigation Map Page Menu



Figure 6-85 Navigation Map Page Setup Menu

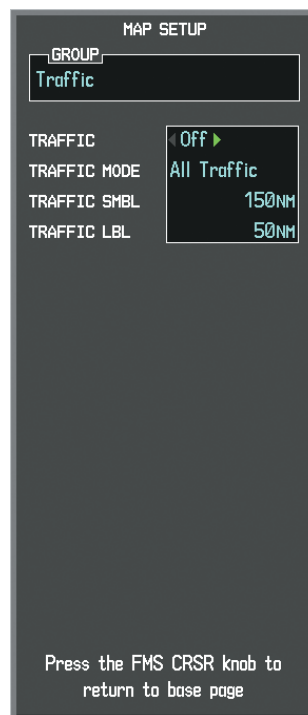

Figure 6-86 Navigation Map Page Setup Menu, Traffic Group

## TRAFFIC MAP PAGE

The Traffic Map Page is specialized to show surrounding TIS traffic data in relation to the aircraft's current position and altitude, without clutter from the basemap. It is the principal page for viewing TIS data. Aircraft orientation on this map is always heading up unless there is no valid heading. Map range is adjustable with the **RANGE** Knob from 2 to 12 nm, as indicated by the map range rings.

The traffic mode is annunciated in the upper left corner of the Traffic Map Page. When the aircraft is on the ground, TIS automatically enters Standby Mode. Once the aircraft is airborne, TIS switches from Standby to Operating Mode and the G1000 begins to display traffic information. Refer to the System Status discussion for more information.

### Displaying traffic on the Traffic Map Page:

- 1) Turn the large **FMS** Knob to select the Map Page Group.
- 2) Turn the small **FMS** Knob to select the Traffic Map Page.
- 3) Confirm TIS is in Operating Mode:  
Press the **OPERATE** Softkey to begin displaying traffic.  
**Or:**
  - a) Press the **MENU** Key.
  - b) Select 'Operate Mode' (shown if TIS is in Standby Mode) and press the **ENT** Key.

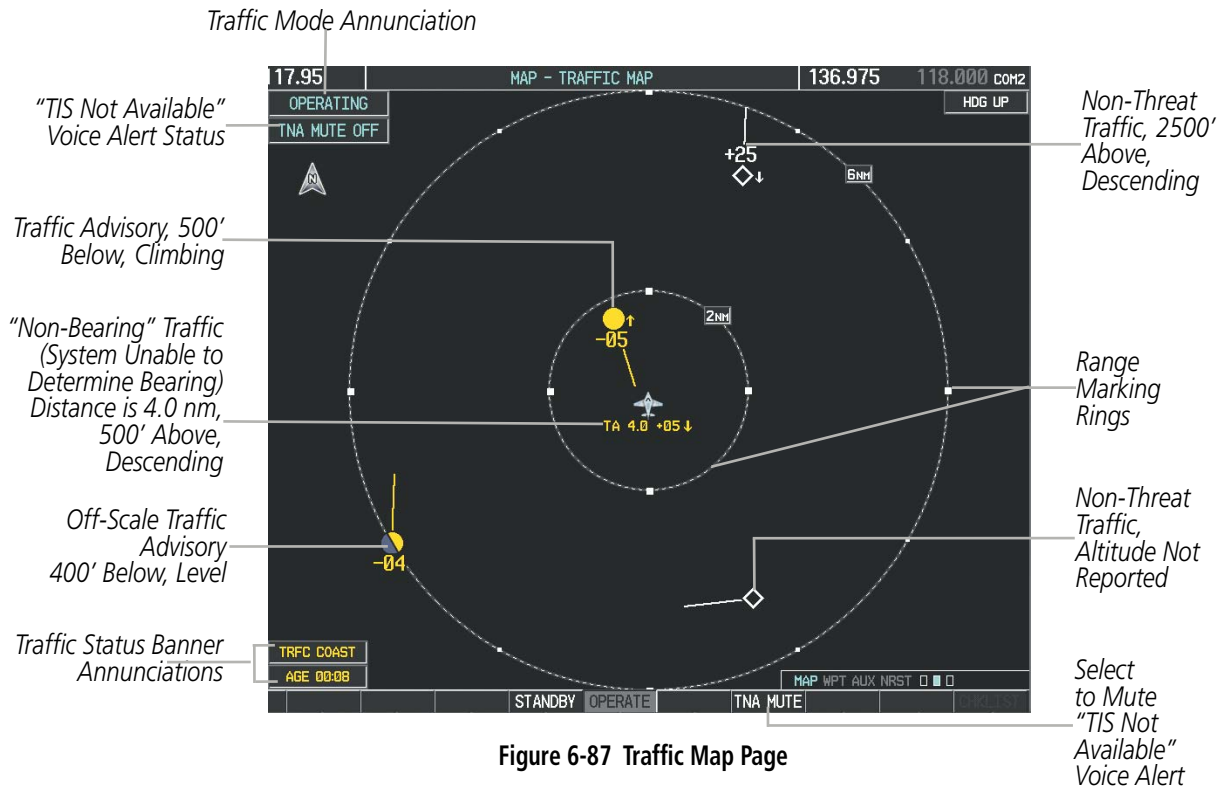

Figure 6-87 Traffic Map Page

## TIS ALERTS

When the number of TAs on the Traffic Map Page increases from one scan to the next, the following occur:

- A single **“Traffic”** voice alert is generated.
- A ‘TRAFFIC’ Annunciation appears to the top left of the Attitude Indicator on the PFD, flashing for 5 seconds and remaining displayed until no TAs are detected in the area.
- The PFD Inset Map is automatically displayed with traffic.

To reduce the number of nuisance alerts due to proximate aircraft, the **“Traffic”** voice alert is generated only when the number of TAs increases. For example, when the first TA is displayed, a voice and visual annunciation are generated. As long as a single TA remains on the display, no additional voice alerts are generated. If a second TA appears on the display or if the number of TAs initially decreases and then subsequently increases, another voice alert is generated.



Figure 6-88 Traffic Annunciation (PFD)

A “**TIS Not Available**” (TNA) voice alert is generated when the TIS service becomes unavailable or is out of range. TIS may be unavailable in the radar coverage area due to the following:

- Radar site TIS Mode S sensor is not operational or is out of service
- Traffic or requesting aircraft is beyond the maximum range of the TIS-capable Mode S radar site.
- Traffic or requesting aircraft is above the radar site in the cone of silence and out of range of an adjacent site.
- Traffic or requesting aircraft is below radar coverage. In flat terrain, the coverage extends from about 3000 feet upward at 55 miles. Terrain and obstacles around the radar site can further decrease radar coverage in all directions.
- Traffic does not have an operating transponder.

The “**TIS Not Available**” (TNA) voice alert can be manually muted to reduce nuisance alerting. TNA muting status is shown in the upper left corner of the Traffic Map Page.

#### Muting the “TIS Not Available” voice alert:

- 1) Select the Traffic Map Page.
  - 2) Press the **TNA MUTE** Softkey. The status is displayed in the upper left corner of the Traffic Map Page.
- Or:
- a) Press the **MENU** Key.
  - b) Select “‘Not Available’ Mute On’ (shown if TNA muting is currently off) and press the **ENT** Key.

SYSTEM STATUS

The G1000 performs an automatic test of TIS during power-up. If TIS passes the test, TIS enters Standby Mode (on the ground) or Operating Mode (in the air). If TIS fails the power up test, an annunciation is shown in the center of the Traffic Map Page.

Traffic Map Page Annunciation	Description
<b>NO DATA</b>	Data is not being received from the transponder*
<b>DATA FAILED</b>	Data is being received from the transponder, but a failure is detected in the data stream*
<b>FAILED</b>	The transponder has failed*
<b>UNAVAILABLE</b>	TIS is unavailable or out of range

\* Contact a service center or Garmin dealer for corrective action

Table 6-13 TIS Failure Annunciations

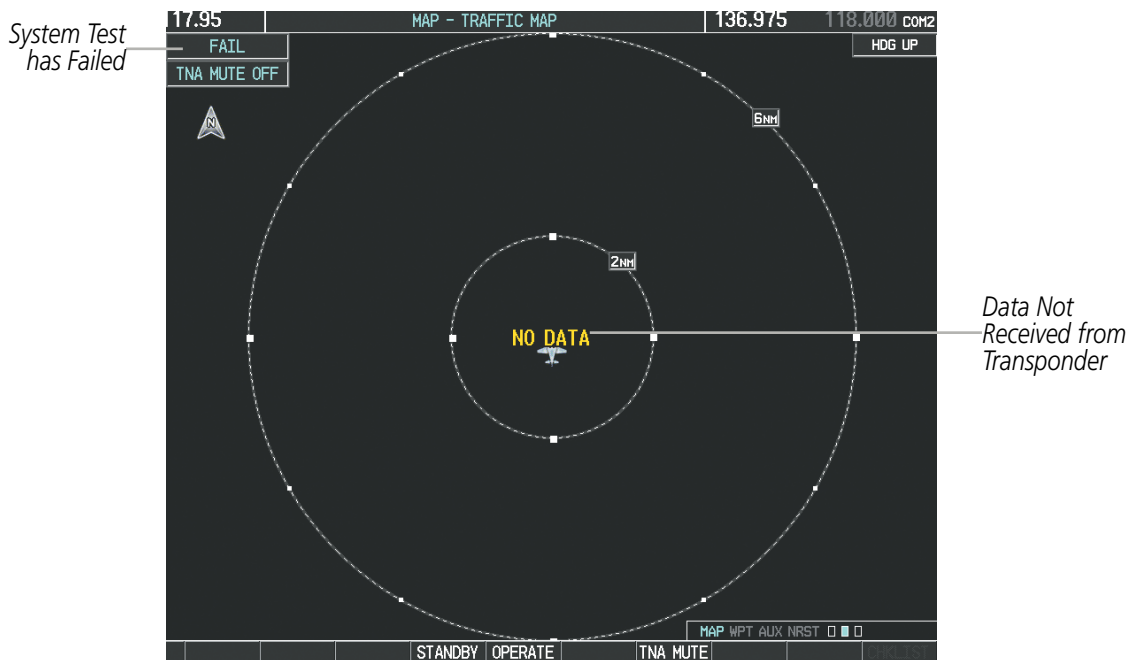

Figure 6-89 TIS Power-up Test Failure

The traffic mode is annunciated in the upper left corner of the Traffic Map Page. When the aircraft is on the ground, TIS automatically enters Standby Mode. If traffic is selected for display on another map while Standby Mode is selected, the traffic display enabled icon is crossed out (also the case whenever TIS has failed). Once the aircraft is airborne, TIS switches to Operating Mode and traffic information is displayed. The mode can be changed manually using softkeys or the page menu.

Mode	Traffic Mode Annunciation (Traffic Map Page)	Traffic Display Enabled Icon (Other Maps)
TIS Operating	<b>OPERATING</b>	
TIS Standby	<b>STANDBY</b> (also shown in white in center of page)	
TIS Failed*	<b>FAIL</b>	

\* See Table 6-15 for additional failure annunciations

Table 6-14 TIS Modes

**Switching between TIS modes:**

- 1) Select the Traffic Map Page.
- 2) Press the **STANDBY** or **OPERATE** Softkey to switch between modes. The mode is displayed in the upper left corner of the Traffic Map Page.

Or:

- a) Press the **MENU** Key.
- b) Select 'Operate Mode' or 'Standby Mode' (choice dependent on current state) and press the **ENT** Key. The annunciations to indicate the status of traffic information appear in a banner at the lower left corner of maps on which traffic can be displayed (Table 6-15).

Traffic Status Banner Annunciation	Description
<b>TA OFF SCALE</b>	A Traffic Advisory is outside the selected display range* Annunciation is removed when traffic comes within the selected display range
<b>TA X.X ± XX ↓</b>	System cannot determine bearing of Traffic Advisory** Annunciation indicates distance in nm, altitude separation in hundreds of feet, and altitude trend arrow (climbing/descending)
<b>AGE MM:SS</b>	Appears if traffic data is not refreshed within 6 seconds If after another 6 seconds data is not received, traffic is removed from the display The quality of displayed traffic information is reduced as the age increases
<b>TRFC COAST</b>	The displayed data is not current (6 to 12 seconds since last message) The quality of displayed traffic information is reduced when this message is displayed
<b>TRFC RMVD</b>	Traffic is removed because it is too old for coasting (12 to 60 seconds since last message) Traffic may exist within the selected display range, but it is not displayed
<b>TRFC FAIL</b>	Traffic data has failed
<b>NO TRFC DATA</b>	Traffic data has not been detected
<b>TRFC UNAVAIL</b>	The traffic service is unavailable or out of range

\*Shown as symbol on Traffic Map Page

\*\*Shown in center of Traffic Map Page

Table 6-15 TIS Traffic Status Banner Annunciations

## 6.7 AVIDYNE TAS600 TRAFFIC



**WARNING:** The Traffic Advisory System (TAS) is intended for advisory use only. TAS is intended to help the pilot locate traffic visually. It is the responsibility of the pilot to see and maneuver to avoid traffic.



**NOTE:** Refer to the Avidyne TAS600 Series Pilot's Guide for a detailed discussion of the Avidyne TAS600 system.



**NOTE:** TIS is disabled if a traffic advisory system (TAS) is installed.

### TAS SYMBOLOGY

The optional Traffic Advisory System (TAS) is designed to help in detection and avoidance of other aircraft. TAS uses an on-board interrogator-processor and the Mode S transponder for the air-to-air traffic data link. Traffic is displayed using the symbols shown in Table 6-16.

TAS Symbol	Description
	Non-Threat Traffic
	Proximity Advisory (PA)
	Traffic Advisory (TA)
	Traffic Advisory Off Scale

Table 6-16 TAS Symbol Description

A Non-threat Advisory, shown as an open white diamond, indicates that an intruding aircraft is at greater than  $\pm 1200$  feet relative altitude or the distance is beyond 5 nm.

A Proximity Advisory indicates that the intruding aircraft is within  $\pm 1200$  feet and is within 5 nm range, but is still not considered a threat.

A Traffic Advisory (TA) alerts the crew to a potentially hazardous intruding aircraft. Closing rate, distance, and vertical separation meet TA criteria. A Traffic Advisory that is beyond the selected display range is indicated by a half TA symbol at the edge of the screen at the relative bearing of the intruder.



## DISPLAYING TRAFFIC DATA

The Map - Traffic Map Page is the principal page for viewing traffic information. Traffic information can be displayed on the following maps as an additional reference:

- PFD Inset Map
- Nearest Pages
- Navigation Map Page
- Active Flight Plan Page
- Trip Planning Page
- AUX - Video Page

### Displaying traffic on the Traffic Map Page:

- 1) Turn the large **FMS** Knob to select the Map Page Group.
- 2) Turn the small **FMS** Knob to select the Traffic Map Page.
- 3) Turn the **RANGE** Knob clockwise to display a larger area or counter-clockwise to display a smaller area.

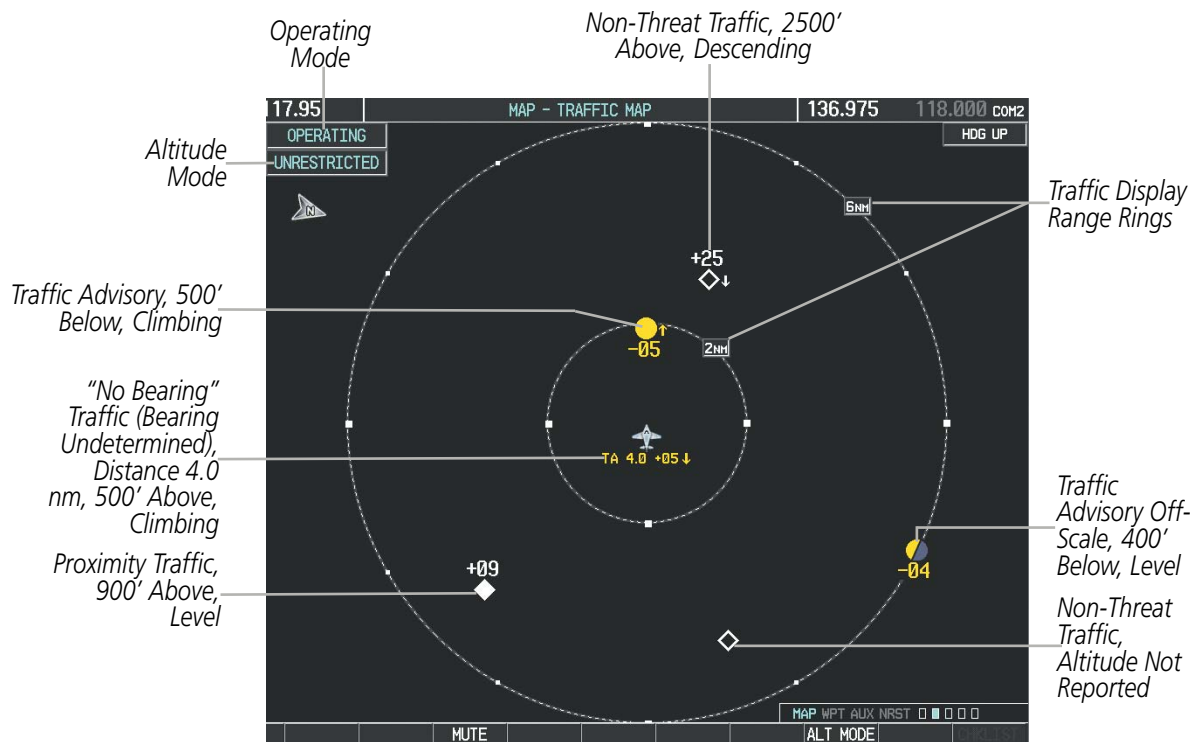

Figure 6-90 Traffic Map Page

The Traffic Map Page shows surrounding TAS traffic data in relation to the aircraft's current position and altitude, without basemap clutter. Aircraft orientation is always heading up unless there is no valid heading. Map range is adjustable with the **RANGE** Knob from 2 to 24 nm, as indicated by the map range rings.

The traffic mode and altitude display mode are annunciated in the upper left corner.

**Displaying traffic information (maps other than the Traffic Map Page):**

- 1) Select the **MAP** Softkey.
- 2) Select the **TRAFFIC** Softkey to display traffic data.

When traffic is selected on maps other than the Traffic Map Page, a traffic icon is shown to indicate TAS is enabled for display.



Figure 6-91 TAS Traffic on Navigation Map Page

**Displaying traffic information (PFD Inset Map):**

- 1) Select the **INSET** Softkey.
- 2) Select the **TRAFFIC** Softkey to display traffic data on the inset map (TRFC-1).
- 3) Select the softkey again to display the traffic-only inset (TRFC-2).
- 4) Select the softkey again to remove traffic data.

**ALTITUDE DISPLAY**

The Pilot can select the volume of airspace in which traffic is displayed. Traffic Advisories (TAs) outside of these limits will still be shown. Refer to the TAS600 Series Pilot’s Guide for specific display thresholds.

**Changing the altitude display mode:**

- 1) On the Traffic Page, select the **ALT MODE** Softkey.
- 2) Select one of the following Softkeys:
  - **BELOW**
  - **NORMAL**
  - **ABOVE**
  - **UNREST** (unrestricted)

- 3) To return to the Traffic Page, select the **BACK** Softkey.

Or:

- 1) Press the **MENU** Key.
- 2) Turn the small **FMS** Knob to select one of the following:
  - **BELOW**
  - **NORMAL**
  - **ABOVE**
  - **UNREST** (unrestricted)
- 3) Select the **ENT** Softkey.

## TRAFFIC MAP PAGE DISPLAY RANGE

The display range on the Traffic Map Page can be changed at any time. Map range is adjustable with the **RANGE** Knob from 2 to 24 nm, as indicated by the map range rings.

### Changing the display range on the Traffic Page:

- 1) Turn the **RANGE** Knob.
- 2) The following range options are available:
  - 2 nm
  - 2 and 6 nm
  - 6 and 12 nm
  - 12 and 24 nm

The Navigation Map Page Setup Menu also controls the display of traffic. The setup menu controls the map range settings. Traffic data symbols and labels can be decluttered from the display. If a map range larger than the map range setting is selected, the data is removed from the map. Maps besides the Traffic Map Page use settings based on those selected for the Navigation Map Page.

### Customizing the traffic display on the Navigation Map Page:

- 1) Select the Navigation Map Page.
- 2) Press the **MENU** Key.
- 3) With Map Setup highlighted, press the **ENT** Key (Figure 6-92).
- 4) Turn the small **FMS** Knob to select the Traffic Group and press the **ENT** Key (Figure 6-93).
- 5) Turn the large **FMS** Knob or press the **ENT** Key to scroll through the selections (Figure 6-94).
  - **TRAFFIC** – Turns the display of traffic data on or off
  - **TRAFFIC MODE** – Selects the traffic mode for display; select from:
    - All Traffic - Displays all traffic
    - TA/PA - Displays Traffic Alerts and Proximity Advisories
    - TA ONLY - Displays Traffic Alerts only

- TRAFFIC SMBL – Selects the maximum range at which traffic symbols are shown
  - TRAFFIC LBL – Selects the maximum range at which traffic labels are shown with the option to turn off
- 6) Turn the small **FMS** Knob to scroll through options (ON/OFF, range settings, etc.).
  - 7) Press the **ENT** Key to select an option.
  - 8) Press the **FMS** Knob or **CLR** Key to return to the Navigation Map Page.



Figure 6-92 Navigation Map Page Menu



Figure 6-93 Navigation Map Page Setup Menu

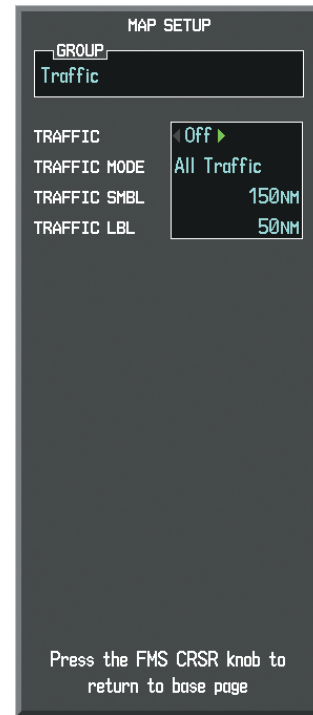

Figure 6-94 Navigation Map Page Setup Menu, Traffic Group

## TAS ALERTS



**NOTE:** Refer to the TAS600 documentation for information on alerts generated by the TAS equipment.

- When the number of TAs on the Traffic Map Page increases from one scan to the next, the following occur:
- A “**Traffic**” voice alert is generated followed by the clock position, relative altitude and range of the TA.
  - A TRAFFIC Annunciation appears at the top right of the airspeed on the PFD, flashing for 5 seconds and remaining displayed until no TAs are detected in the area.
  - The PFD Inset Map is automatically displayed with TA traffic.

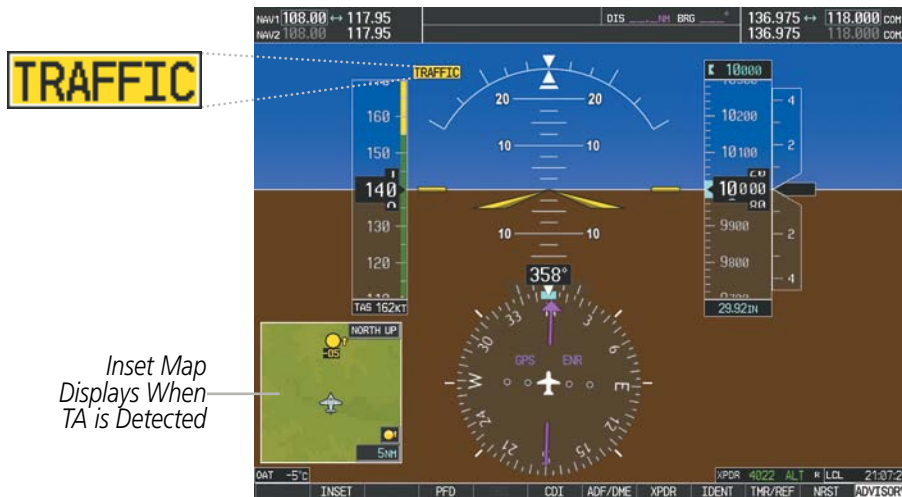

Figure 6-95 Traffic Annunciation (PFD)

### TAS VOICE ALERTS

To listen to an update of Traffic Advisories select the **MUTE** Softkey twice.

#### Muting the TAS voice alert in progress:

- 1) Select the Traffic Map Page.
- 2) Select the **MUTE** Softkey while the voice alert is playing. Subsequent voice alerts will be heard.

### SYSTEM STATUS



**NOTE:** Refer to the TAS600 documentation for information on the operating mode.

The traffic mode is annunciated in the upper left corner of the Traffic Map Page.

Mode	Traffic Mode Annunciation (Traffic Map Page)	Traffic Display Enabled Icon (Other Maps)
TAS Operating	OPERATING	
TAS Failed*	FAIL	

\* See Table 6-18 for additional failure annunciations

Table 6-17 TAS Modes

If the unit fails, an annunciation as to the cause of the failure is shown in the center of the Traffic Map Page.

Traffic Map Page Annunciation	Description
<b>NO DATA</b>	Data is not being received from the TAS unit
<b>DATA FAILED</b>	Data is being received from the TAS unit, but the unit is self-reporting a failure
<b>FAILED</b>	Incorrect data format received from the TAS unit

Table 6-18 TAS Failure Annunciations

The annunciations to indicate the status of traffic information appear in a banner at the lower left corner of maps on which traffic can be displayed.

Traffic Status Banner Annunciation	Description
<b>TA OFF SCALE</b>	A Traffic Advisory is outside the selected display range* Annunciation is removed when traffic comes within the selected display range
<b>TA X.X ± XX ↓</b>	System cannot determine bearing of Traffic Advisory** Annunciation indicates distance in nm, altitude separation in hundreds of feet, and altitude trend arrow (climbing/descending)
<b>TRFC FAIL</b>	TAS unit has failed (unit is self-reporting a failure or sending incorrectly formatted data)
<b>NO TRFC DATA</b>	Data is not being received from the TAS unit

\*Shown as symbol on Traffic Map Page

\*\*Shown in center of Traffic Map Page

Table 6-19 TAS Traffic Status Annunciations

SYSTEM  
OVERVIEW

FLIGHT  
INSTRUMENTS

EIS

AUDIO PANEL  
& CNS

FLIGHT  
MANAGEMENT

**HAZARD  
AVOIDANCE**

AFCS

ADDITIONAL  
FEATURES

APPENDICES

INDEX

**BLANK PAGE**



## SECTION 7 AUTOMATIC FLIGHT CONTROL SYSTEM (OPTIONAL)



**NOTE:** The approved Aircraft Flight Manual (AFM) always supersedes the information in this Pilot's Guide.



**NOTE:** A failure of the primary (#1) Integrated Avionics Unit (IAU) results in loss of the flight director. Any IAU failure results in loss of the autopilot and manual electric trim.

The GFC 700 is a digital Automatic Flight Control System (AFCS), fully integrated within the G1000 System avionics architecture. The System Overview section provides a block diagram (Figure 1-1) to support this system description. GFC 700 AFCS functionality in Diamond DA40NG aircraft is distributed across the following Line Replaceable Units (LRUs):

- GDU 1040 Primary Flight Display (PFD)
- GDU 1040/1044 Multi-Function Display (MFD)
- GIA 63/63W Integrated Avionics Units (2)
- GSA 81 AFCS Servo (3)
- GSM 85 (or GSM 86) Servo Mounts (3)

The GFC 700 AFCS can be divided into these main operating functions:

- **Flight Director (FD)** — Flight director operation takes place within the primary (#1) IAU. Flight director commands are displayed on the PFD. The flight director provides:
  - Command Bars showing pitch/roll guidance
  - Pitch/roll mode selection and processing
  - Autopilot communication
- **Autopilot (AP)** — Autopilot operation occurs within the pitch, roll, and pitch trim servo and provides servo monitoring and automatic flight control in response to flight director steering commands, AHRS attitude and rate information, and airspeed.
- **Manual Electric Trim (MET)** — The pitch trim servo provides manual electric trim capability when the autopilot is not engaged.

## 7.1 AFCS CONTROLS

The following dedicated AFCS keys are located on the bezel of the MFD:

- ① **AP Key** Engages/disengages the autopilot
- ② **FD Key** Activates/deactivates the flight director only  
Pressing once turns on the flight director in the default pitch and roll modes. Pressing again deactivates the flight director and removes the Command Bars. If the autopilot is engaged, the key is disabled.
- ③ **NAV Key** Selects/deselects Navigation Mode
- ④ **ALT Key** Selects/deselects Altitude Hold Mode
- ⑤ **VS Key** Selects/deselects Vertical Speed Mode
- ⑥ **FLC Key** Selects/deselects Flight Level Change Mode
- ⑦ **HDG Key** Selects/deselects Heading Select Mode
- ⑧ **APR Key** Selects/deselects Approach Mode
- ⑨ **VNV Key**  
(GDU 1044 only) Selects/deselects Vertical Path Tracking Mode for Vertical Navigation flight control
- ⑩ **NOSE UP/NOSE DN Keys** Control the mode reference in Pitch Hold, Vertical Speed, and Flight Level Change modes

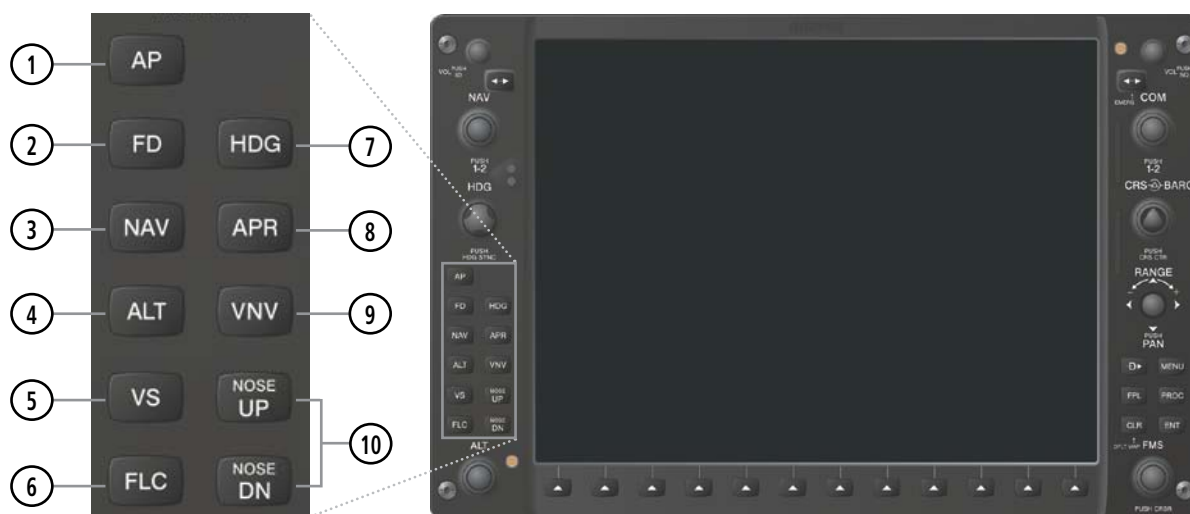

Figure 7-1 Dedicated MFD AFCS Controls (GDU 1044)

The following AFCS controls are located in the cockpit separately from the MFD:

- |  |   |
|--|---|
| <b>AP DISC Switch</b><br><b>(Autopilot Disconnect)</b> | <p>Disengages the autopilot and interrupts pitch trim operation</p> <p>This switch may be used to mute the aural autopilot disconnect alert.</p> <p>The <b>AP DISC</b> Switch is located on each control stick.</p>   |
| <b>CWS Button</b><br><b>(Control Wheel Steering)</b>   | <p>While pressed, allows manual control of the aircraft while the autopilot is engaged and synchronizes the flight director's Command Bars with the current aircraft pitch (if not in Glideslope Mode) and roll (if in Roll Hold Mode)</p> <p>Upon release of the <b>CWS</b> Button, the flight director may establish new reference points, depending on the current pitch and roll modes. CWS operation details are discussed in the flight director modes section.</p> <p>The <b>CWS</b> Button is located on the top of the left control stick.</p>   |
| <b>GA Switch (Go Around)</b>                           | <p>Disengages the autopilot and selects flight director Go Around Mode</p> <p>If an approach procedure is loaded this switch also activates the missed approach when the selected navigation source is GPS or when the navigation source is VOR/LOC and a valid frequency has been tuned.</p> <p>The <b>GA</b> Switch is located on the throttle handle.</p>  |
| <b>AP TRIM Switch</b><br><b>(Autopilot Trim)</b>       | <p>Used to command manual electric trim</p> <p>This composite switch is split into left and right sides. The left switch is the ARM contact and the right switch controls the DN (forward) and UP (rearward) contacts. The <b>AP TRIM</b> ARM switch can be used to disengage the autopilot and to acknowledge an autopilot disconnect alert and mute the associated aural tone.</p> <p>Manual trim commands are generated only when both sides of the switch are operated simultaneously. If either side of the switch is active separately for more than three seconds, MET function is disabled and 'PTRM' is displayed as the AFCS Status Annunciation on the PFD. The function remains disabled until both sides of the switch are inactivated.</p> <p>The <b>AP TRIM</b> Switch is located on the left control stick.</p> |

## 7.2 FLIGHT DIRECTOR OPERATION

The flight director function provides pitch and roll commands to the AFCS and displays them on the PFD. With the flight director activated, the aircraft can be hand-flown to follow the path shown by the Command Bars. Maximum commanded pitch (-15°/+20°) and roll (22°) angles, vertical acceleration, and roll rate are limited to values established during AFCS certification. The flight director also provides commands to the autopilot.

### ACTIVATING THE FLIGHT DIRECTOR

An initial press of a key listed in Table 7-1 (when the flight director is not active) activates the flight director in the listed modes. The flight director may be turned off and the Command Bars removed from the display by pressing the **FD** Key again. The **FD** Key is disabled when the autopilot is engaged.

Control Pressed	Modes Selected			
	Lateral		Vertical	
<b>FD</b> Key	Roll Hold (default)	ROL	Pitch Hold (default)	PIT
<b>AP</b> Key	Roll Hold (default)	ROL	Pitch Hold (default)	PIT
<b>CWS</b> Button	Roll Hold (default)	ROL	Pitch Hold (default)	PIT
<b>GA</b> Switch	Takeoff (on ground)	TO	Takeoff (on ground)	TO
	Go Around (in air)	GA	Go Around (in air)	GA
<b>ALT</b> Key	Roll Hold (default)	ROL	Altitude Hold	ALT
<b>VS</b> Key	Roll Hold (default)	ROL	Vertical Speed	VS
<b>VNV</b> Key	Roll Hold (default)	ROL	Vertical Path Tracking*	VPTH
<b>NAV</b> Key	Navigation**	GPS	Pitch Hold (default)	PIT
		VOR		
		LOC		
		BC		
<b>APR</b> Key	Approach**	GPS	Pitch Hold (default)	PIT
		VOR		
		LOC		
<b>HDG</b> Key	Heading Select	HDG	Pitch Hold (default)	PIT

\*Valid VNV flight plan must be entered before **VNV** Key press activates flight director.

\*\*The selected navigation receiver must have a valid VOR or LOC signal or active GPS course before **NAV** or **APR** Key press activates flight director.

**Table 7-1 Flight Director Activation**

**AFCS STATUS BOX**

Flight director mode annunciations are displayed on the PFD when the flight director is active. Autopilot status is displayed in the center of the AFCS Status Box. Lateral flight director modes are displayed on the left and vertical on the right. Armed modes are annunciated in white and active in green.

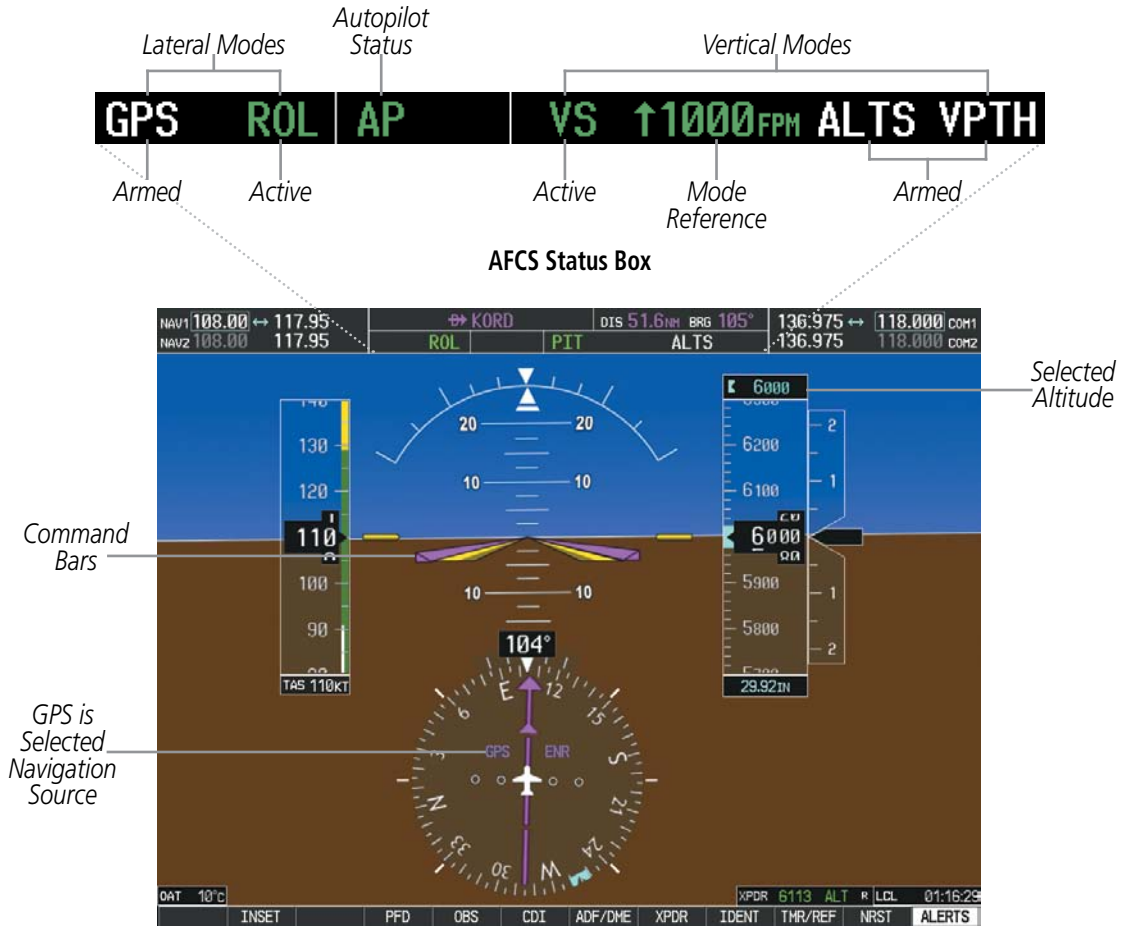

Figure 7-2 PFD AFCS Display

## COMMAND BARS

Upon activation of the flight director, Command Bars are displayed on the PFD as a single magenta cue. The Command Bars move together vertically to indicate pitch commands and bank left or right to indicate roll commands. The Command Bars do not override the aircraft symbol.

If the attitude information sent to the flight director becomes invalid or unavailable, the Command Bars are removed from the display. The flight director Command Bars also disappear if the pitch exceeds  $+30^{\circ}/-20^{\circ}$  or bank exceeds  $65^{\circ}$ .

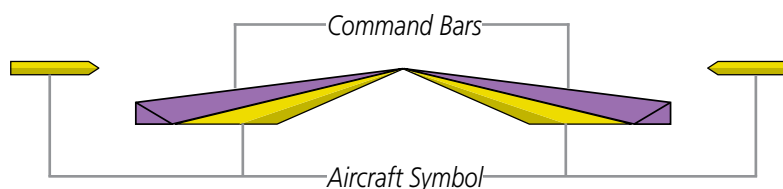

Figure 7-3 Command Bars

## FLIGHT DIRECTOR MODES

Flight director modes are normally selected independently for the pitch and roll axes. Unless otherwise specified, all mode keys are alternate action (i.e., press on, press off). In the absence of specific mode selection, the flight director reverts to the default pitch and/or roll mode(s).

Armed modes are annunciated in white and active in green in the AFCS Status Box. Under normal operation, when the control for the active flight director mode is pressed, the flight director reverts to the default mode(s) for the axis(es). Automatic transition from armed to active mode is indicated by the white armed mode annunciation moving to the green active mode field and flashing for 10 seconds.

If the information required to compute a flight director mode becomes invalid or unavailable, the flight director automatically reverts to the default mode for that axis. A flashing yellow mode annunciation and annunciator light indicate loss of sensor (ADC) or navigation data (VOR, LOC, GPS, VNV, SBAS) required to compute commands. When such a loss occurs, the system automatically begins to roll the wings level (enters Roll Hold Mode) or maintain the pitch angle (enters Pitch Hold Mode), depending on the affected axis. The flashing annunciation stops when the affected mode key is pressed or another mode for the axis is selected. If after 10 seconds no action is taken, the flashing annunciation stops.



Figure 7-4 Loss of VOR Signal

The flight director is automatically disabled if the attitude information required to compute the default flight director modes becomes invalid or unavailable.

### 7.3 VERTICAL MODES

Table 7-2 lists the vertical modes with their corresponding controls and annunciations. The mode reference is displayed next to the active mode annunciation for Altitude Hold, Vertical Speed, and Flight Level Change modes. The **NOSE UP/NOSE DN** Keys can be used to change the vertical mode reference while operating under Pitch Hold, Vertical Speed, or Flight Level Change Mode. Increments of change and acceptable ranges of values for each of these references using the **NOSE UP/NOSE DN** Keys are also listed in the table.

Vertical Mode	Description	Control	Annunciation	Reference Range	Reference Change Increment
Pitch Hold	Holds aircraft pitch attitude; may be used to climb/descend to the Selected Altitude	(default)	PIT	-15° to +20°	0.5°
Selected Altitude Capture	Captures the Selected Altitude	*	ALTS		
Altitude Hold	Holds current Altitude Reference	<b>ALT</b> Key	ALT   nnnnn FT		
Vertical Speed	Holds aircraft vertical speed; may be used to climb/descend to the Selected Altitude	<b>VS</b> Key	VS   nnnn FPM	-3000 to +1500 fpm	100 fpm
Flight Level Change	Holds aircraft airspeed while aircraft is climbing/descending to the Selected Altitude	<b>FLC</b> Key	FLC   nnn KT	70 to 165 kt	1 kt
Vertical Path Tracking	Captures and tracks descent legs of an active vertical profile	<b>VNV</b> Key	VPTH		
VNV Target Altitude Capture	Captures the Vertical Navigation (VNV) Target Altitude	**	ALTV		
Glidepath***	Captures and tracks the SBAS glidepath on approach	<b>APR</b> Key	GP		
Glideslope	Captures and tracks the ILS glideslope on approach		GS		
Go Around	Disengages the autopilot and commands a constant pitch angle and wings level	<b>GA</b> Switch	GA	7°	

\* *ALTS is armed automatically when PIT, VS, FLC, or GA is active, and under VPTH when the Selected Altitude is to be captured instead of the VNV Target Altitude.*

\*\* *ALTV is armed automatically under VPTH when the VNV Target Altitude is to be captured instead of the Selected Altitude.*

\*\*\* *GP is available in installations with GIA 63W IAUs when SBAS is available.*

**Table 7-2 Flight Director Vertical Modes**



## PITCH HOLD MODE (PIT)

When the flight director is activated (the **FD** Key is pressed), Pitch Hold Mode is selected by default. Pitch Hold Mode is indicated as the active pitch mode by the green annunciation 'PIT'. This mode may be used for climb or descent to the Selected Altitude (shown above the Altimeter), since Selected Altitude Capture Mode is automatically armed when Pitch Hold Mode is activated.

In Pitch Hold Mode, the flight director maintains a constant pitch attitude, the pitch reference. The pitch reference is set to the aircraft pitch attitude at the moment of mode selection. If the aircraft pitch attitude exceeds the flight director pitch command limitations, the flight director commands a pitch angle equal to the nose-up/down limit.

### CHANGING THE PITCH REFERENCE

When operating in Pitch Hold Mode, the pitch reference can be adjusted by:

- Using the **NOSE UP/NOSE DN** Keys
- Pressing the **CWS** Button, hand-flying the aircraft to establish a new pitch reference, then releasing the **CWS** Button

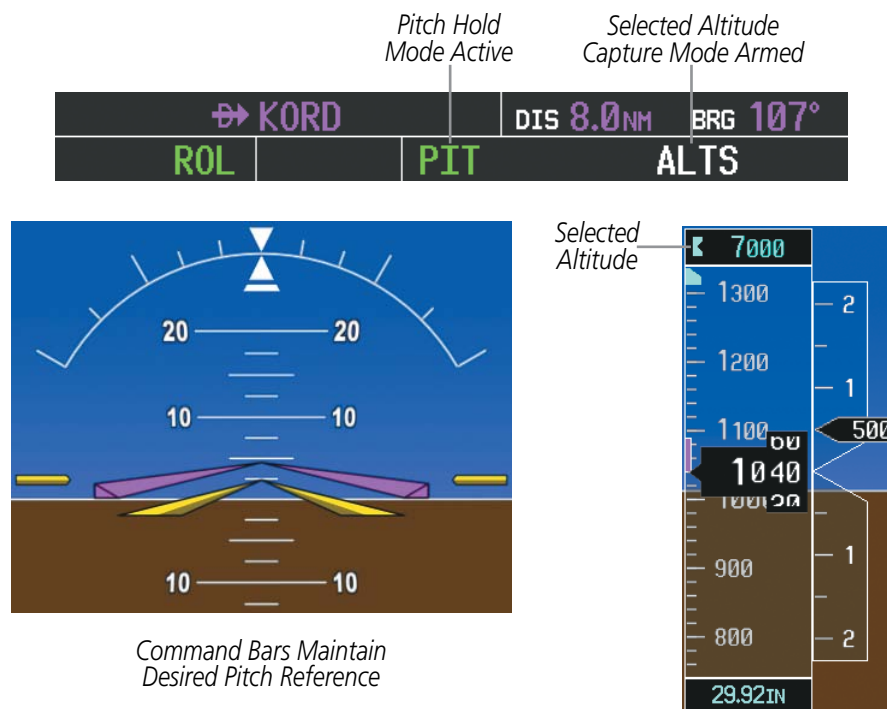

Figure 7-5 Pitch Hold Mode

## SELECTED ALTITUDE CAPTURE MODE (ALTS)

Selected Altitude Capture Mode is automatically armed with activation of the following modes:

- Pitch Hold
- Vertical Speed
- Flight Level Change
- Go Around
- Vertical Path Tracking (if the Selected Altitude is to be captured instead of the VNV Target Altitude)

The white 'ALTS' annunciation indicates Selected Altitude Capture Mode is armed (see Figure 7-5 for example). The **ALT** Knob is used to set the Selected Altitude (shown above the Altimeter) until Selected Altitude Capture Mode becomes active.

As the aircraft nears the Selected Altitude, the flight director automatically transitions to Selected Altitude Capture Mode with Altitude Hold Mode armed (Figure 7-6). This automatic transition is indicated by the green 'ALTS' annunciation flashing for up to 10 seconds and the appearance of the white 'ALT' annunciation. The Selected Altitude is shown as the Altitude Reference beside the 'ALTS' annunciation.

At 50 feet from the Selected Altitude, the flight director automatically transitions from Selected Altitude Capture to Altitude Hold Mode and holds the Selected Altitude (shown as the Altitude Reference). As Altitude Hold Mode becomes active, the white 'ALT' annunciation moves to the active pitch mode field and flashes green for 10 seconds to indicate the automatic transition.

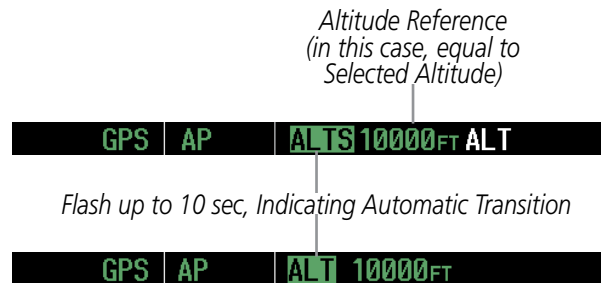

Figure 7-6 Automatic Mode Transitions During Altitude Capture

## CHANGING THE SELECTED ALTITUDE



**NOTE:** Pressing the **CWS** Button while in Selected Altitude Capture Mode does not cancel the mode.

Use of the **ALT** Knob to change the Selected Altitude while Selected Altitude Capture Mode is active causes the flight director to revert to Pitch Hold Mode with Selected Altitude Capture Mode armed for the new Selected Altitude.

## ALTITUDE HOLD MODE (ALT)

Altitude Hold Mode can be activated by pressing the **ALT** Key; the flight director maintains the current aircraft altitude (to the nearest 10 feet) as the Altitude Reference. The flight director's Altitude Reference, shown in the AFCS Status Box, is independent of the Selected Altitude, displayed above the Altimeter. Altitude Hold Mode active is indicated by a green 'ALT' annunciation in the AFCS Status Box.

Altitude Hold Mode is automatically armed when the flight director is in Selected Altitude Capture Mode (see Figure 7-6). Selected Altitude Capture Mode automatically transitions to Altitude Hold Mode when the altitude error is less than 50 feet. In this case, the Selected Altitude becomes the flight director's Altitude Reference.

### CHANGING THE ALTITUDE REFERENCE



**NOTE:** Turning the **ALT** Knob while in Altitude Hold Mode changes the Selected Altitude, but not the flight director's Altitude Reference, and does not cancel the mode.

With the **CWS** Button depressed, the aircraft can be hand-flown to a new Altitude Reference. When the **CWS** Button is released at the desired altitude, the new altitude is established as the Altitude Reference.

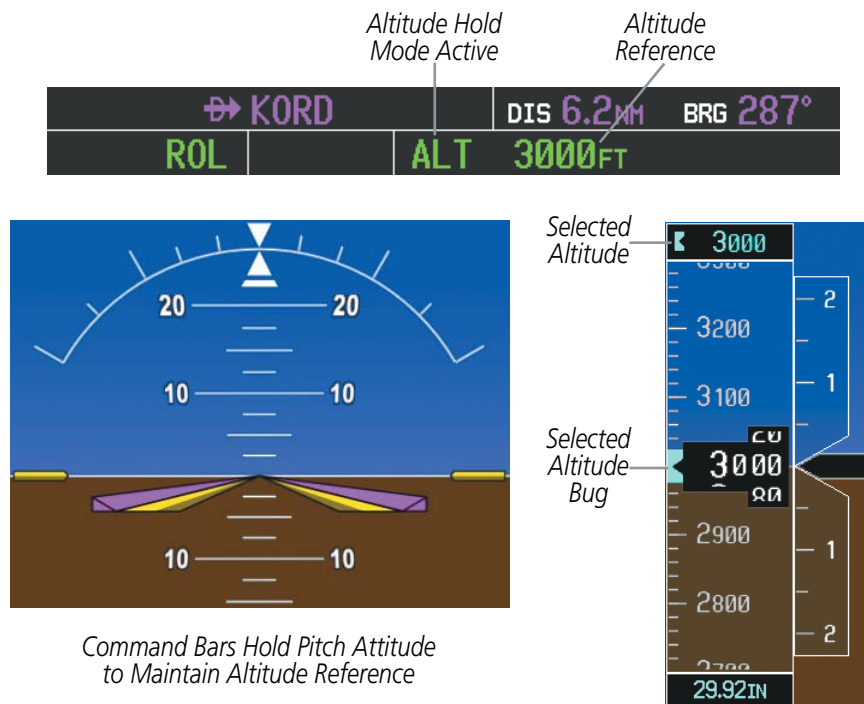

Figure 7-7 Altitude Hold Mode

## VERTICAL SPEED MODE (VS)

In Vertical Speed Mode, the flight director acquires and maintains a Vertical Speed Reference. Current aircraft vertical speed (to the nearest 100 fpm) becomes the Vertical Speed Reference at the moment of Vertical Speed Mode activation. This mode may be used for climb or descent to the Selected Altitude (shown above the Altimeter) since Selected Altitude Capture Mode is automatically armed when Vertical Speed Mode is selected.

When Vertical Speed Mode is activated by pressing the **VS** Key, 'VS' is annunciated in green in the AFCS Status Box along with the Vertical Speed Reference. The Vertical Speed Reference is also displayed above the Vertical Speed Indicator. A Vertical Speed Reference Bug corresponding to the Vertical Speed Reference is shown on the indicator.

### CHANGING THE VERTICAL SPEED REFERENCE

The Vertical Speed Reference (shown both in the AFCS Status Box and above the Vertical Speed Indicator) may be changed by:

- Using the **NOSE UP/NOSE DN** Keys
- Pressing the **CWS** Button, hand-flying the aircraft to attain a new Vertical Speed Reference, then releasing the **CWS** Button



**NOTE:** If the Selected Altitude is reached during CWS maneuvering, the Altitude Reference is not changed. To adjust the Altitude Reference in this case, the CWS Button must be pressed again after the Selected Altitude is reached.

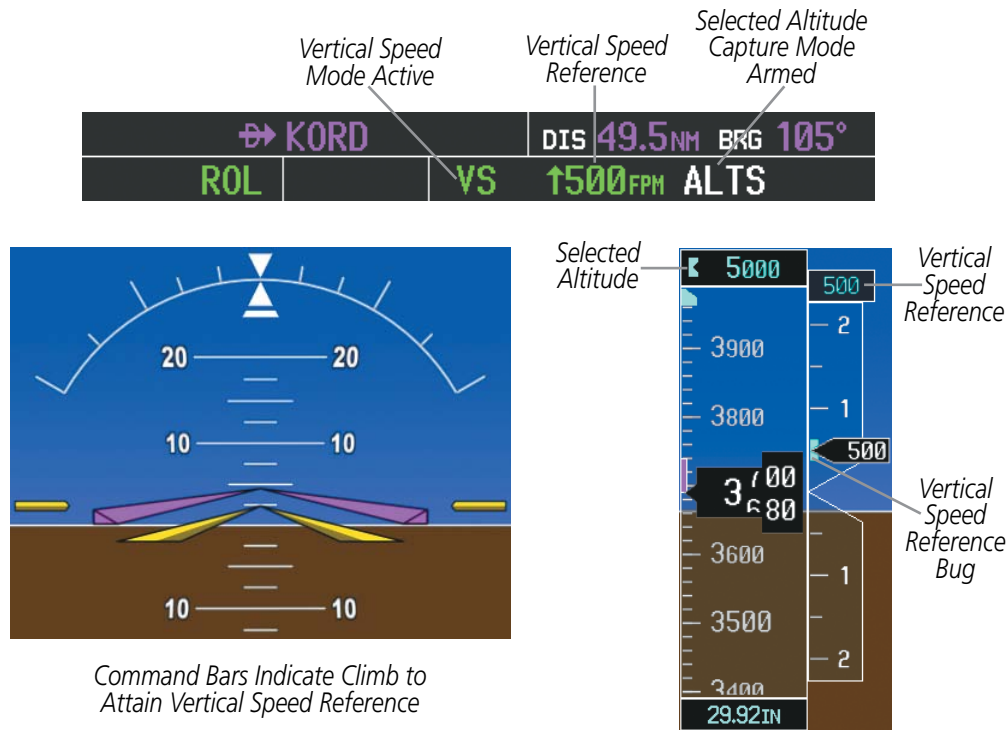

Figure 7-8 Vertical Speed Mode

## FLIGHT LEVEL CHANGE MODE (FLC)



**NOTE:** *The Selected Altitude should be set before selecting Flight Level Change Mode.*

Flight Level Change Mode is selected by pressing the **FLC** Key. This mode acquires and maintains the Airspeed Reference while climbing or descending to the Selected Altitude (shown above the Altimeter). When Flight Level Change Mode is active, the flight director continuously monitors Selected Altitude, airspeed, and altitude.

The Airspeed Reference is set to the current airspeed upon mode activation. Flight Level Change Mode is indicated by a green 'FLC' annunciation beside the Airspeed Reference in the AFCS Status Box. The Airspeed Reference is also displayed directly above the Airspeed Indicator, along with a bug corresponding to the Airspeed Reference along the tape.

Engine power must be adjusted to allow the autopilot to fly the aircraft at a pitch attitude corresponding to the desired flight profile (climb or descent) while maintaining the Airspeed Reference. The flight director maintains the current altitude until either engine power or the Airspeed Reference are adjusted and does not allow the aircraft to climb or descend away from the Selected Altitude.

### CHANGING THE AIRSPEED REFERENCE

The Airspeed Reference (shown in both the AFCS Status Box and above the Airspeed Indicator) may be adjusted by:

- Using the **NOSE UP/NOSE DN** Keys
- Pressing the **CWS** Button, hand-flying the aircraft to a new airspeed, then releasing the **CWS** Button to establish the new Airspeed Reference



**NOTE:** *If the Selected Altitude is reached during CWS maneuvering, the Airspeed Reference is not changed. To adjust the Airspeed Reference in this case, the CWS Button must be pressed again after the Selected Altitude is reached.*

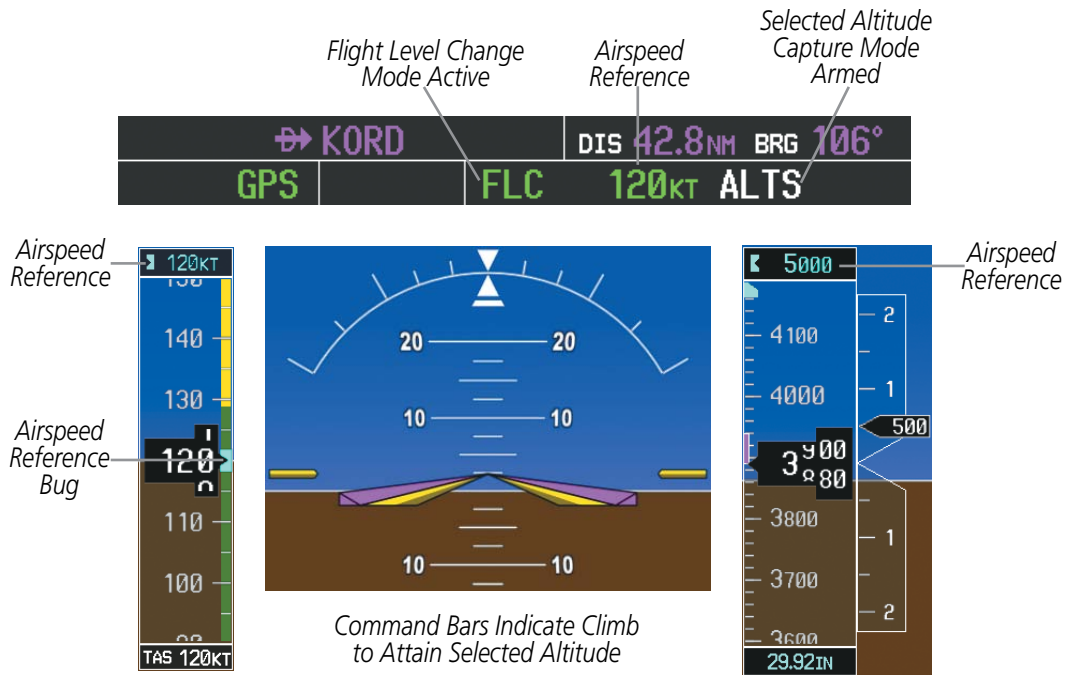

Figure 7-9 Flight Level Change Mode

## VERTICAL NAVIGATION MODES (VPTH, ALTV)

**NOTE:** VNV is disabled when parallel track or dead reckoning mode is active.

**NOTE:** The Selected Altitude takes precedence over any other vertical constraints.

Vertical Navigation (VNV) flight control is available for enroute/terminal cruise and descent operations any time that VNV flight planning is available. Refer to the Flight Management Section for more information on VNV flight plans. Conditions for availability include, but are not limited to:

- The selected navigation source is GPS.
- A VNV flight plan (with at least one altitude-constrained waypoint) or vertical direct-to is active.
- VNV is enabled (**VNV ENBL** Softkey pressed on the MFD).
- Crosstrack error is valid and within certain limits.
- Desired/actual track are valid or track angle error is within certain limits.
- The VNV Target Altitude of the active waypoint is no more than 250 ft above the current aircraft altitude.

The flight director may be armed for VNV at any time, but no target altitudes are captured during a climb. The Command Bars provide vertical profile guidance based on specified altitudes (entered manually or loaded from the database) at waypoints in the active flight plan or vertical direct-to. The appropriate VNV flight control modes are sequenced by the flight director to follow the path defined by the vertical profile. Upon reaching the last waypoint in the VNV flight plan, the flight director transitions to Altitude Hold Mode and cancels any armed VNV modes.

### VERTICAL PATH TRACKING MODE (VPTH)

**NOTE:** If another pitch mode key is pressed while Vertical Path Tracking Mode is selected, Vertical Path Tracking Mode reverts to armed.

**NOTE:** Pressing the **CWS** Button while Vertical Path Tracking Mode is active does not cancel the mode. The autopilot guides the aircraft back to the descent path upon release of the **CWS** Button.

When a vertical profile (VNV flight plan) is active and the **VNV** Key is pressed, Vertical Path Tracking Mode is armed in preparation for descent path capture. 'VPTH' (or 'V' when Glidepath or Glideslope Mode is concurrently armed) is annunciated in white in addition to previously armed modes. If applicable, the appropriate altitude capture mode is armed for capture of the next VNV Target Altitude (ALTV) or the Selected Altitude (ALTS), whichever is greater.



Figure 7-10 Vertical Path Tracking Armed Annunciations



Prior to descent path interception, the Selected Altitude must be set below the current aircraft altitude by at least 75 feet. For the flight director to transition from Altitude Hold to Vertical Path Tracking Mode, acknowledgment is required within 5 minutes of descent path interception by:

- Pressing the **VNV** Key
- Adjusting the Selected Altitude

If acknowledgment is not received within 1 minute of descent path interception, the white 'VPTH' annunciation starts to flash. Flashing continues until acknowledged or the descent path is intercepted. If the descent is not confirmed by the time of interception, Vertical Path Tracking Mode remains armed and the descent is not captured.

In conjunction with the "TOD [top of descent] within 1 minute" annunciation in the Navigation Status Box and the "Vertical track" voice message, VNV indications (VNV Target Altitude, vertical deviation, and vertical speed required) appear on the PFD in magenta (Figure 7-11).

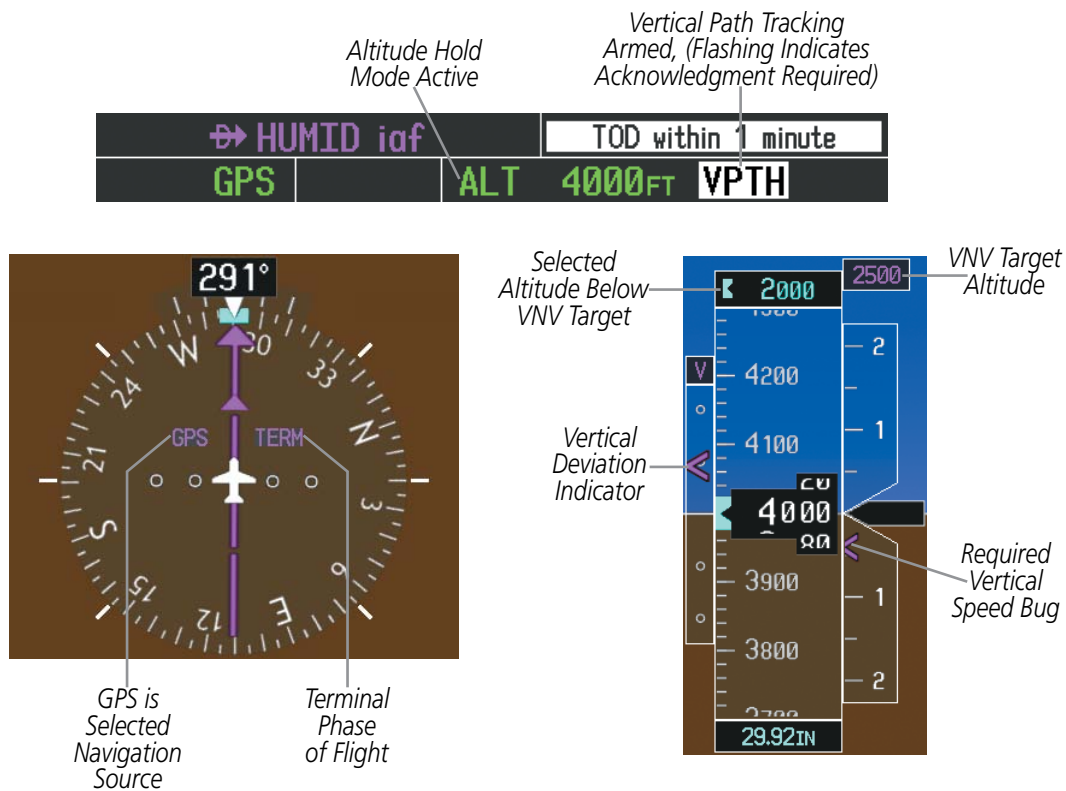
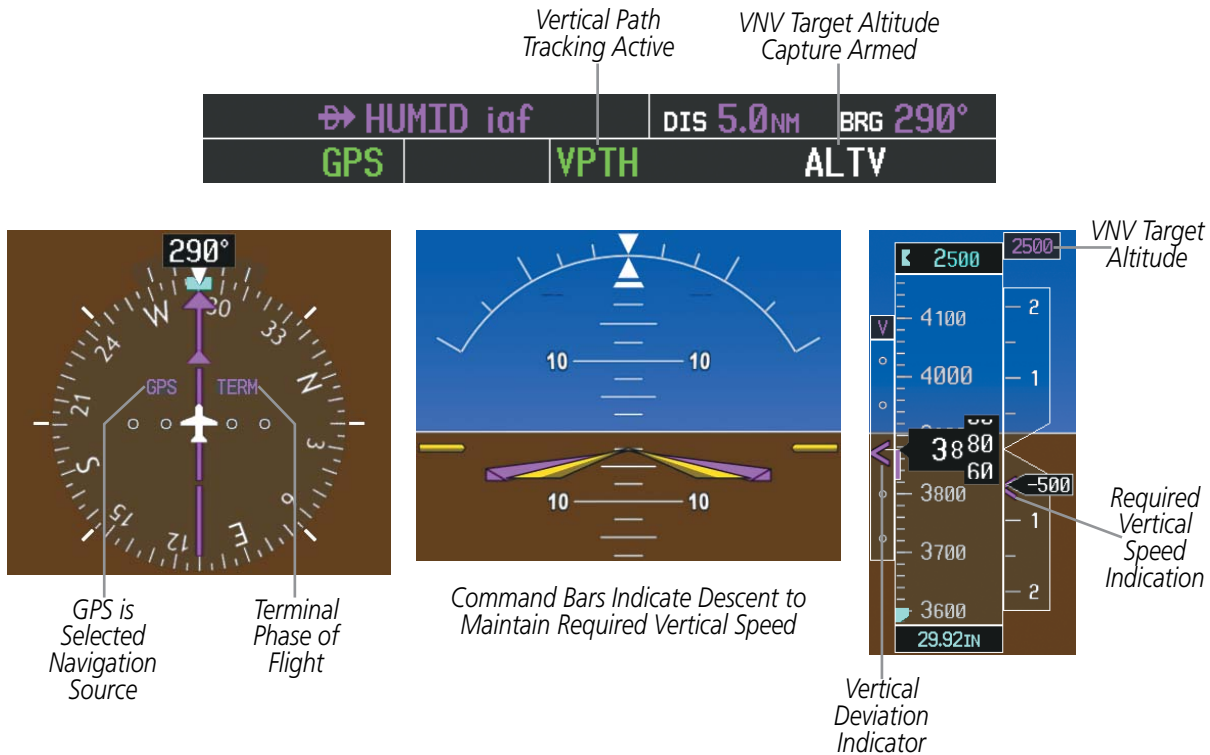

Figure 7-11 Vertical Path Capture

When a descent leg is captured (i.e., vertical deviation becomes valid), Vertical Path Tracking becomes active and tracks the descent profile. An altitude capture mode ('ALTS' or 'ALTV') is armed as appropriate.



**Figure 7-12 Vertical Path Tracking Mode**

If the Altimeter's barometric setting is adjusted while Vertical Path Tracking is active, the flight director increases/decreases the descent rate by up to 500 fpm to re-establish the aircraft on the descent path (without commanding a climb). Adjusting the altimeter barometric setting creates discontinuities in VNV vertical deviation, moving the descent path. For large adjustments, it may take several minutes for the aircraft to re-establish on the descent path. If the change is made while nearing a waypoint with a VNV Target Altitude, the aircraft may not re-establish on the descent path in time to meet the vertical constraint.

- SYSTEM OVERVIEW
- FLIGHT INSTRUMENTS
- EIS
- AUDIO PANEL & CNS
- FLIGHT MANAGEMENT
- HAZARD AVOIDANCE
- AFCS
- ADDITIONAL FEATURES
- APPENDICES
- INDEX

### AUTOMATIC REVERSION TO PITCH HOLD MODE

Several situations can occur while Vertical Path Tracking Mode is active which cause the flight director to revert to Pitch Hold Mode:

- Vertical deviation exceeds 200 feet during an overspeed condition.
- Vertical deviation experiences a discontinuity that both exceeds 200 feet in magnitude and results in the vertical deviation exceeding 200 feet in magnitude. Such discontinuities are usually caused by flight plan changes that affect the vertical profile.
- Vertical deviation becomes invalid (the Vertical Deviation Indicator is removed from the PFD).
- A display enters Reversionary Mode (this does not apply to an active vertical direct-to).

Unless VNV is disabled, Vertical Path Tracking Mode and the appropriate altitude capture mode become armed following the reversion to Pitch Hold Mode to allow for possible profile recapture.

### NON-PATH DESCENTS

Pitch Hold, Vertical Speed, and Flight Level Change modes can also be used to fly non-path descents while VNV flight control is selected. If the **VS** or **FLC** Key is pressed while Vertical Path Tracking Mode is selected, Vertical Path Tracking Mode reverts to armed along with the appropriate altitude capture mode to allow profile re-capture.



Figure 7-13 Flight Level Change VNV Non-Path Descent

To prevent immediate profile re-capture, the following must be satisfied:

- At least 10 seconds have passed since the non-path transition was initiated
- Vertical deviation from the profile has exceeded 250 feet, but is now less than 200 feet

Pressing the **VNV** Key twice re-arms Vertical Path Tracking for immediate profile re-capture.

## VNV TARGET ALTITUDE CAPTURE MODE (ALTV)



**NOTE:** Armed VNV Target Altitude and Selected Altitude capture modes are mutually exclusive. However, Selected Altitude Capture Mode is armed implicitly (not annunciated) whenever VNV Target Altitude Capture Mode is armed.

VNV Target Altitude Capture is analogous to Selected Altitude Capture Mode and is armed automatically after the **VNV** Key is pressed and the next VNV Target Altitude is to be intercepted before the Selected Altitude. The annunciation ‘ALTV’ indicates that the VNV Target Altitude is to be captured. VNV Target Altitudes are shown in the active flight plan or vertical direct-to, and can be entered manually or loaded from a database (see the Flight Management Section for details). At the same time as “TOD within 1 minute” is annunciated in the Navigation Status Box, the active VNV Target Altitude is displayed above the Vertical Speed Indicator (see Figure 7-11).

As the aircraft nears the VNV Target Altitude, the flight director automatically transitions to VNV Target Altitude Capture Mode with Altitude Hold Mode armed. This automatic transition is indicated by the green ‘ALTV’ annunciation flashing for up to 10 seconds and the appearance of the white ‘ALT’ annunciation. The VNV Target Altitude is shown as the Altitude Reference beside the ‘ALTV’ annunciation and remains displayed above the Vertical Speed Indicator. The Required Vertical Speed Indication (RVSI) is removed once VNV Target Altitude Capture Mode becomes active.

At 50 feet from the VNV Target Altitude, the flight director automatically transitions from VNV Target Altitude Capture to Altitude Hold Mode and tracks the level leg. As Altitude Hold Mode becomes active, the white ‘ALT’ annunciation moves to the active vertical mode field and flashes green for 10 seconds to indicate the automatic transition. The flight director automatically arms Vertical Path Tracking, allowing upcoming descent legs to be captured and subsequently tracked.

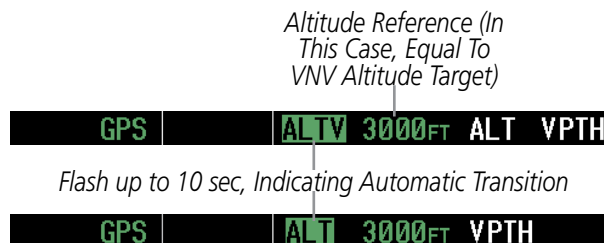

Figure 7-14 Automatic Mode Transitions During Altitude Capture

### CHANGING THE VNV TARGET ALTITUDE



**NOTE:** Pressing the **CWS** Button while in VNV Target Altitude Capture Mode does not cancel the mode.

Changing the current VNV Target Altitude while VNV Target Altitude Capture Mode is active causes the flight director to revert to Pitch Hold Mode. Vertical Path Tracking and the appropriate altitude capture mode are armed in preparation to capture the new VNV Target Altitude or the Selected Altitude, depending on which altitude is to be intercepted first.

VNV target altitudes can be changed while editing the active flight plan (see the Flight Management Section for details).

## GLIDEPATH MODE (GP) (SBAS ONLY)



**NOTE:** Refer to the Aircraft Flight Manual (AFM) to determine whether SBAS functionality is approved.



**NOTE:** Pressing the **CWS** Button while Glidepath Mode is active does not cancel the mode. The autopilot guides the aircraft back to the glidepath upon release of the **CWS** Button.

Glidepath Mode is available only in installations with GIA 63W IAUs when SBAS is available. Glidepath Mode is used to track the SBAS-based glidepath. When Glidepath Mode is armed, 'GP' is annunciated in white in the AFCS Status Box.

### Selecting Glidepath Mode:

- 1) Ensure a GPS approach with vertical guidance or vertical descent angle (LPV, LNAV/VNAV, LNAV+V) is loaded into the active flight plan. The active waypoint must be part of the flight plan (cannot be a direct-to a waypoint not in the flight plan).
- 2) Ensure that GPS is the selected navigation source (use the **CDI** Softkey to cycle through navigation sources).
- 3) Press the **APR** Key.



**NOTE:** Some RNAV (GPS) approaches provide a vertical descent angle as an aid in flying a stabilized approach. These approaches are NOT considered Approaches with Vertical Guidance (APV). Approaches that are annunciated on the HSI as LNAV or LNAV+V are considered Nonprecision Approaches (NPA) and are flown to an MDA even though vertical glidepath (GP) information may be provided.



**WARNING:** When flying an LNAV approach (with vertical descent angle) with the autopilot coupled, the aircraft will not level off at the MDA even if the MDA is set in the altitude preselect.

Upon reaching the glidepath, the flight director transitions to Glidepath Mode and begins to capture and track the glidepath.



Figure 7-15 Glidepath Mode Armed

Once the following conditions have been met, the glidepath can be captured:

- The active waypoint is at or after the final approach fix (FAF)
- Vertical deviation is valid
- The CDI is at less than full scale deviation
- Automatic sequencing of waypoints has not been suspended (no 'SUSP' annunciation on the HSI)

- SYSTEM OVERVIEW
- FLIGHT INSTRUMENTS
- EIS
- AUDIO PANEL & CNS
- FLIGHT MANAGEMENT
- HAZARD AVOIDANCE
- AFCS
- ADDITIONAL FEATURES
- APPENDICES
- INDEX

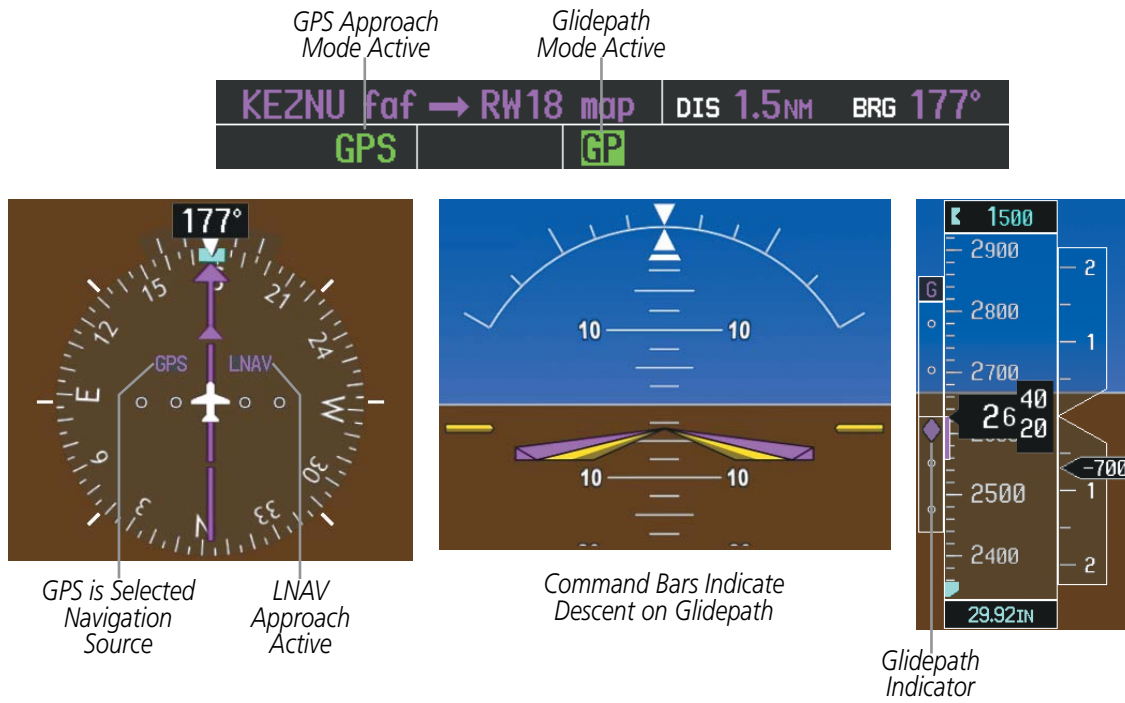

Figure 7-16 Glidepath Mode

## GLIDESLOPE MODE (GS)

**NOTE:** Pressing the **CWS** Button while Glideslope Mode is active does not cancel the mode. The autopilot guides the aircraft back to the glideslope upon release of the **CWS** Button.

Glideslope Mode is available for LOC/ILS approaches to capture and track the glideslope. When Glideslope Mode is armed (annunciated as 'GS' in white), LOC Approach Mode is armed as the lateral flight director mode.

### Selecting Glideslope Mode:

- 1) Ensure a valid localizer frequency is tuned.
- 2) Ensure that LOC is the selected navigation source (use the **CDI** Softkey to cycle through navigation sources).
- 3) Press the **APR** Key.

Or:

- 1) Ensure that GPS is the selected navigation source (use the **CDI** Softkey to cycle through navigation sources).
- 2) Ensure a LOC/ILS approach is loaded into the active flight plan.
- 3) Ensure the corresponding LOC frequency is tuned.
- 4) Press the **APR** Key.



Figure 7-17 Glideslope Mode Armed

Once LOC is the navigation source, the localizer and glideslope can be captured. Upon reaching the glideslope, the flight director transitions to Glideslope Mode and begins to capture and track the glideslope.

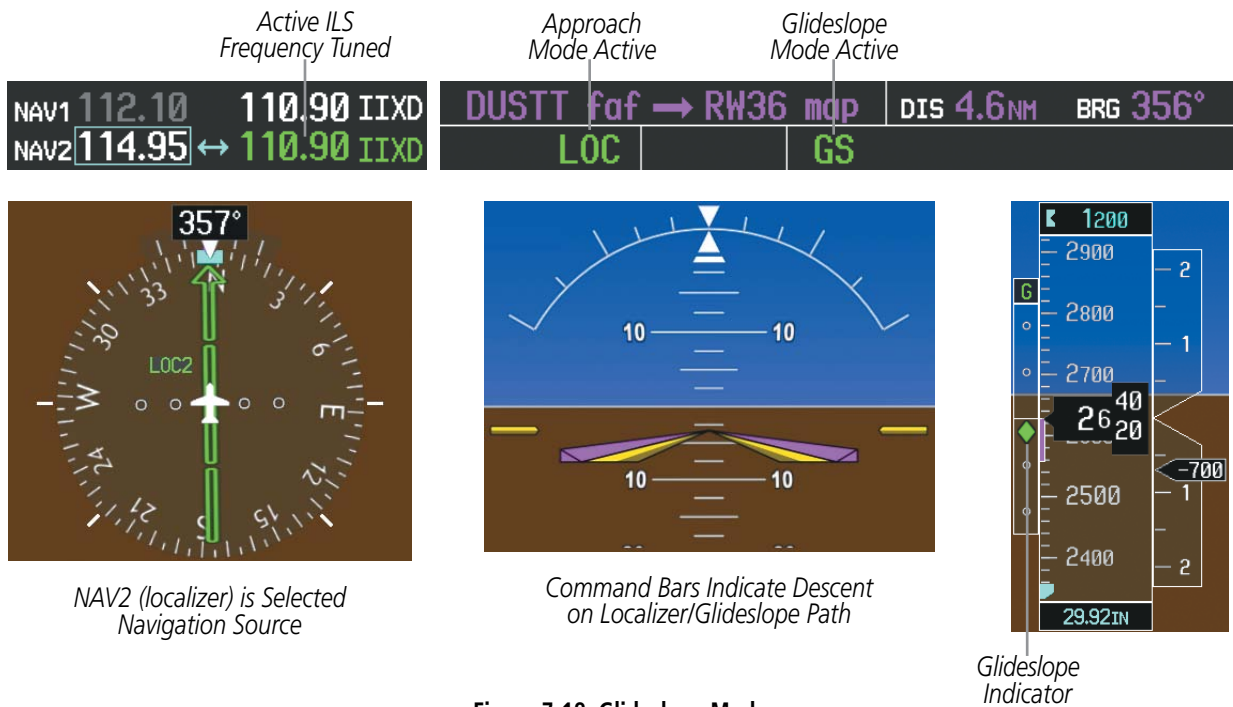

Figure 7-18 Glideslope Mode



SYSTEM OVERVIEW

FLIGHT INSTRUMENTS

EIS

AUDIO PANEL & CNS

FLIGHT MANAGEMENT

HAZARD AVOIDANCE

AFCS

ADDITIONAL FEATURES

APPENDICES

INDEX

## GO AROUND MODE (GA)

Pushing the **GA** Switch engages the flight director in a wings-level, pitch-up attitude, allowing the execution of a missed approach or a go around. This mode is a coupled pitch and roll mode and is annunciated as ‘GA’ in both the active pitch and roll mode fields. Go Around Mode disengages the autopilot and arms Selected Altitude Capture Mode automatically. Subsequent autopilot engagement is allowed. Attempts to modify the aircraft attitude (i.e., with the **CWS** Button or **NOSE UP/NOSE DN** Keys) result in reversion to Pitch and Roll Hold modes.

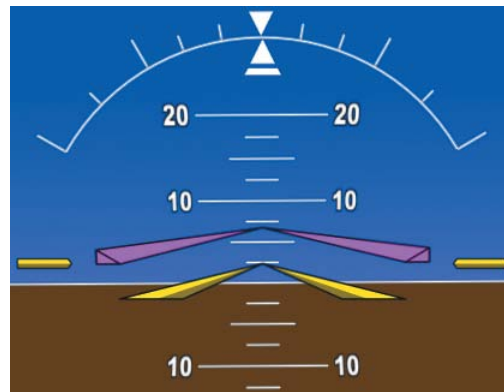
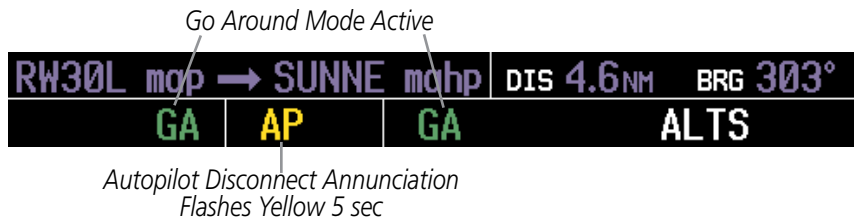

Command Bars Indicate Climb

Figure 7-19 Go Around Mode

## 7.4 LATERAL MODES

The GFC 700 offers the lateral modes listed in Table 7-3. Refer to the vertical modes section for information regarding Go Around Mode.

Lateral Mode	Description	Control	Annunciation	Maximum Roll Command Limit
Roll Hold	Holds the current aircraft roll attitude or rolls the wings level, depending on the commanded bank angle	(default)	ROL	22°
Heading Select	Captures and tracks the Selected Heading	<b>HDG</b> Key	HDG	22°
Navigation, GPS	Captures and tracks the selected navigation source (GPS, VOR, LOC)	<b>NAV</b> Key	GPS	22°
Navigation, VOR Enroute Capture/Track			VOR	22° Capture 10° Track
Navigation, LOC Capture/Track (No Glideslope)			LOC	22° Capture 10° Track
Navigation Backcourse Capture/Track			BC	22° Capture 10° Track
Approach, GPS	Captures and tracks the selected navigation source (GPS, VOR, LOC)	<b>APR</b> Key	GPS	22°
Approach, VOR Capture/Track			VAPP	22° Capture 10° Track
Approach, LOC Capture/Track (Glideslope Mode automatically armed)			LOC	22° Capture 10° Track
Go Around	Disengages the autopilot and commands a constant pitch angle and wings level	<b>GA</b> Switch	GA	Wings Level

*The GFC 700 limits turn rate to 3 degrees per second (standard rate turn).*

**Table 7-3 Flight Director Lateral Modes**

The **CWS** Button does not change lateral references for Heading Select, Navigation, Backcourse, or Approach modes. The autopilot guides the aircraft back to the Selected Heading/Course upon release of the **CWS** Button.

## ROLL HOLD MODE (ROL)



**NOTE:** If Roll Hold Mode is activated as a result of a mode reversion, the flight director rolls the wings level.

When the flight director is activated, Roll Hold Mode is selected by default. This mode is annunciated as 'ROL' in the AFCS Status Box. The current aircraft bank angle is held, subject to the bank angle conditions listed in Table 7-4.



Figure 7-20 Roll Hold Mode Annunciation

Bank Angle	Flight Director Response
< 6°	Rolls wings level
6 to 22°	Maintains current aircraft roll attitude
> 22°	Limits bank to 22°

Table 7-4 Roll Hold Mode Responses

## CHANGING THE ROLL REFERENCE

The roll reference can be changed by pressing the **CWS** Button, establishing the desired bank angle, then releasing the **CWS** Button.

## HEADING SELECT MODE (HDG)

Heading Select Mode is activated by pressing the **HDG** Key. Heading Select Mode acquires and maintains the Selected Heading. The Selected Heading is shown by a light blue bug on the HSI and in the box to the upper left of the HSI.

### CHANGING THE SELECTED HEADING

**NOTE:** Pressing the **HDG** Knob synchronizes the Selected Heading to the current heading.

The Selected Heading is adjusted using the **HDG** Knob. Pressing the **CWS** Button and hand-flying the aircraft does not change the Selected Heading. The autopilot guides the aircraft back to the Selected Heading upon release of the **CWS** Button.

Turns are commanded in the same direction as Selected Heading Bug movement, even if the bug is turned more than 180° from the present heading (e.g., a 270° turn to the right). However, Selected Heading changes of more than 340° at a time result in turn reversals.

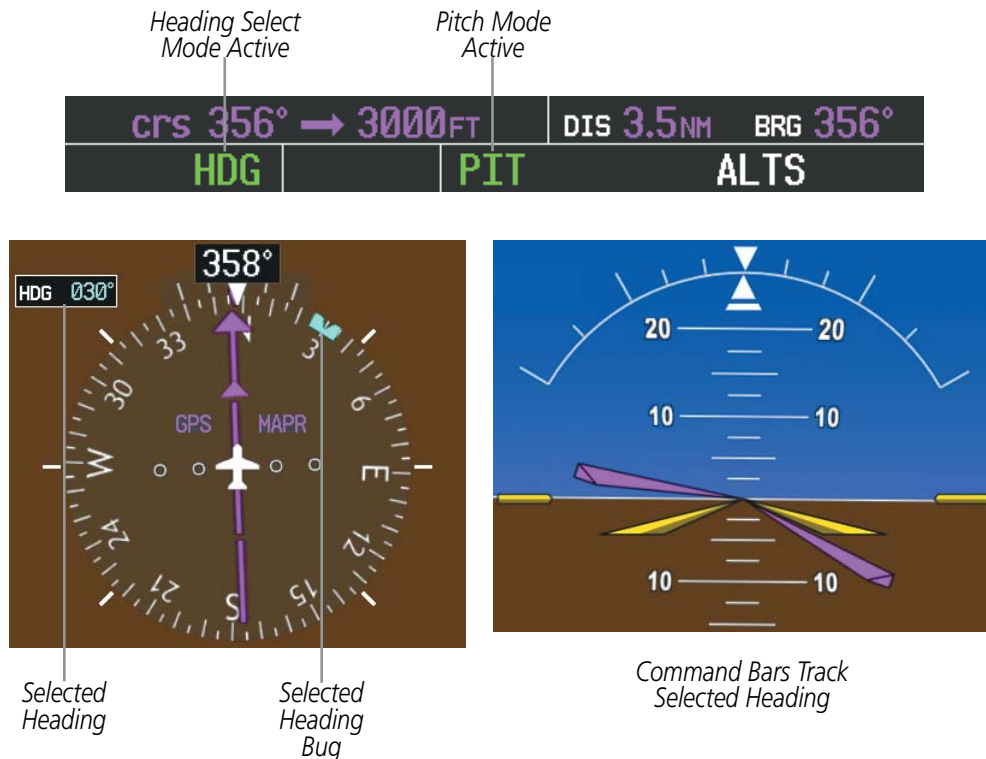

Figure 7-21 Heading Select Mode

## NAVIGATION MODES (GPS, VOR, LOC, BC)

**NOTE:** The selected navigation receiver must have a valid VOR or LOC signal or active GPS course for the flight director to enter Navigation Mode.

**NOTE:** When intercepting a flight plan leg, the flight director gives commands to capture the active leg at approximately a 45° angle to the track between the waypoints defining the active leg. The flight director does not give commands fly to the starting waypoint of the active leg.

**NOTE:** When making a backcourse approach, set the Selected Course to the localizer front course.

Pressing the **NAV** Key selects Navigation Mode. Navigation Mode acquires and tracks the selected navigation source (GPS, VOR, LOC). The flight director follows GPS roll steering commands when GPS is the selected navigation source. When the navigation source is VOR or LOC, the flight director creates roll steering commands from the Selected Course and deviation. Navigation Mode can also be used to fly non-precision GPS and LOC approaches where glideslope capture is not required.

Backcourse Navigation Mode is selected when the localizer front course is greater than 105° from the aircraft heading. Backcourse Navigation Mode captures and tracks a localizer signal in the backcourse direction. The annunciation 'BC' in the AFCS Status Box indicates Backcourse Navigation Mode.

If the Course Deviation Indicator (CDI) shows greater than one dot when the **NAV** Key is pressed, the selected mode is armed. If the CDI is less than one dot, Navigation Mode is automatically captured when the **NAV** Key is pressed. The armed annunciation appears in white to the left of the active roll mode.



**Figure 7-22 GPS Navigation Mode Armed**

When the CDI has automatically switched from GPS to LOC during a LOC/ILS approach, GPS Navigation Mode remains active, providing GPS steering guidance until the localizer signal is captured. LOC Navigation Mode is armed automatically when the navigation source switch takes place if the **APR** Key is not pressed prior to the automatic source switch.

If Navigation Mode is active and either of the following occur, the flight director reverts to Roll Hold Mode (wings rolled level):

- Different VOR tuned while in VOR Navigation Mode (VOR Navigation Mode reverts to armed)
- Navigation source manually switched (with the **CDI** Softkey)
- During a LOC/ILS approach the FAF is crossed while in GPS Navigation Mode after the automatic navigation source switch from GPS to LOC

CHANGING THE SELECTED COURSE

The Selected Course is controlled using the **CRS** Knob (while in VOR, LOC, or OBS Mode). Pressing the **CWS** Button and hand-flying the aircraft does not change the Selected Course while in Navigation Mode. The autopilot guides the aircraft back to the Selected Course (or GPS flight plan) when the **CWS** Button is released.

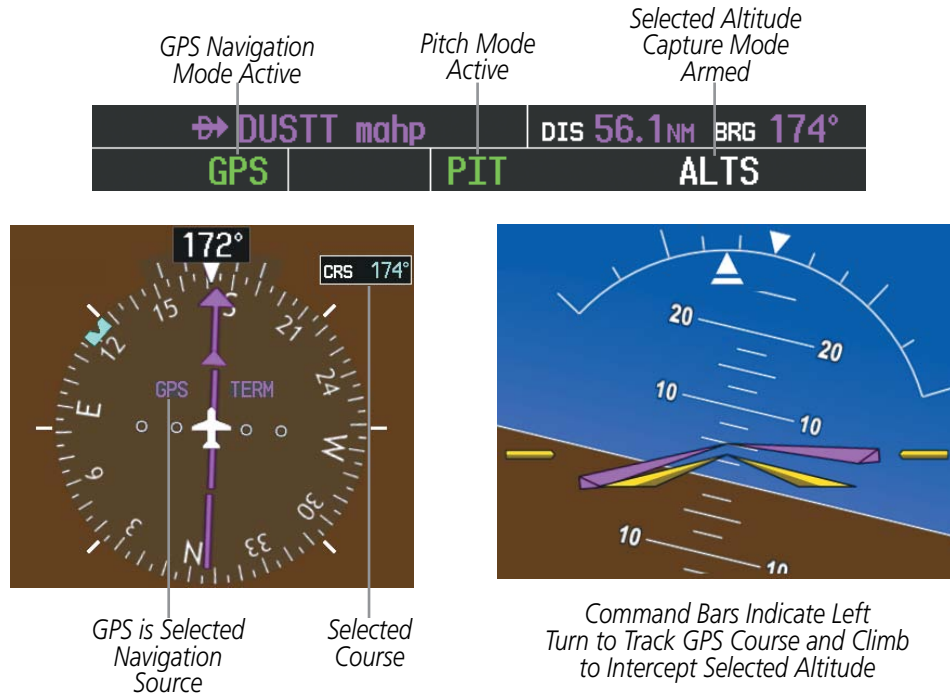

Figure 7-23 Navigation Mode

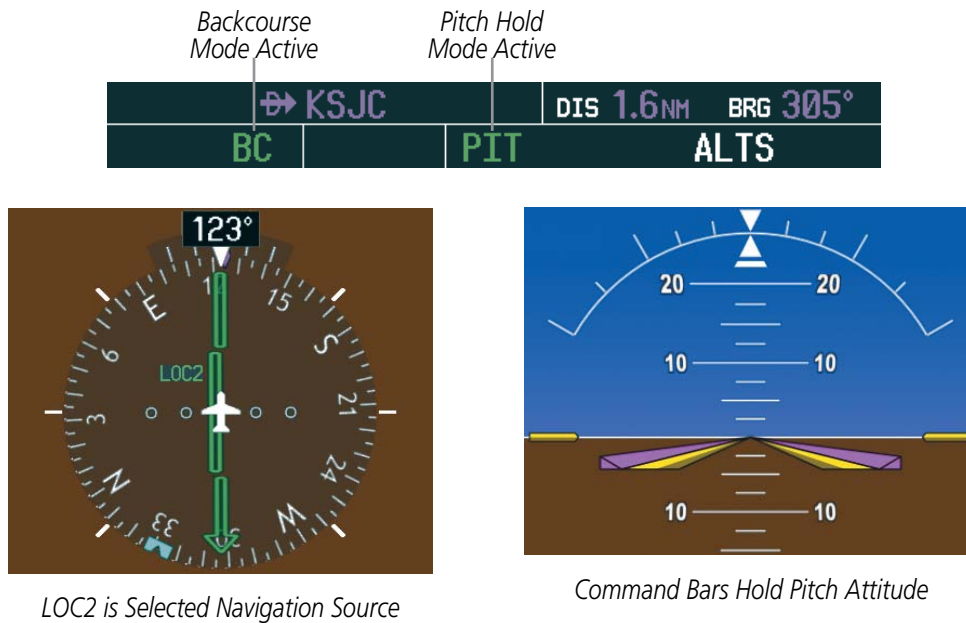

Figure 7-24 Backcourse Mode

## APPROACH MODES (GPS, VAPP, LOC)



**NOTE:** The selected navigation receiver must have a valid VOR or LOC signal or active GPS course for the flight director to enter Approach Mode.

Approach Mode is activated when the **APR** Key is pressed. Approach Mode acquires and tracks the selected navigation source (GPS, VOR, or LOC), depending on loaded approach. This mode uses the selected navigation receiver deviation and desired course inputs to fly the approach. Pressing the **APR** Key when the CDI is greater than one dot arms the selected approach mode (annunciated in white to the left of the active lateral mode). If the CDI is less than one dot, the LOC is automatically captured when the **APR** Key is pressed.

VOR Approach Mode (VAPP) provides greater sensitivity for signal tracking than VOR Navigation Mode.

### Selecting VOR Approach Mode:

- 1) Ensure a valid VOR frequency is tuned
- 2) Ensure that VOR is the selected navigation source (use the **CDI** Softkey to cycle through navigation sources if necessary).
- 3) Press the **APR** Key.

When GPS Approach Mode is armed, Glidepath Mode is also armed.

### Selecting GPS Approach Mode:

- 1) Ensure a GPS approach is loaded into the active flight plan. The active waypoint must be part of the flight plan (cannot be a direct-to a waypoint not in the flight plan).
- 2) Ensure that GPS is the selected navigation source (use the **CDI** Softkey to cycle through navigation sources if necessary).
- 3) Press the **APR** Key.

GPS	GPS	PIT	ALTS
-----	-----	-----	------

Figure 7-25 GPS Approach Mode Armed



LOC Approach Mode allows the autopilot to fly a LOC/ILS approach with a glideslope. When LOC Approach Mode is armed, Glideslope Mode is also armed automatically. LOC captures are inhibited if the difference between aircraft heading and localizer course exceeds 105°.

### Selecting LOC Approach Mode:

- 1) Ensure a valid localizer frequency is tuned.
- 2) Ensure that LOC is the selected navigation source (use the **CDI** Softkey to cycle through navigation sources if necessary).
- 3) Press the **APR** Key.

Or:

- 1) Ensure that GPS is the selected navigation source (use the **CDI** Softkey to cycle through navigation sources if necessary).
- 2) Ensure a LOC/ILS approach is loaded into the active flight plan.
- 3) Ensure the corresponding LOC frequency is tuned.
- 4) Press the **APR** Key.

If the following occurs, the flight director reverts to Roll Hold Mode (wings rolled level):

- Approach Mode is active and a Vectors-To-Final is activated
- Approach Mode is active and Navigation source is manually switched
- During a LOC/ILS approach, GPS Navigation Mode is active and the FAF is crossed after the automatic navigation source switch from GPS to LOC

## CHANGING THE SELECTED COURSE

The Selected Course is controlled using the **CRS** Knob (while in VOR, LOC, or OBS Mode). Pressing the **CWS** Button and hand-flying the aircraft does not change the Selected Course while in Approach Mode. The autopilot guides the aircraft back to the Selected Course (or GPS flight plan) when the **CWS** Button is released.

## INTERCEPTING AND FLYING A DME ARC

The AFCS will intercept and track a DME arc that is part of the active flight plan provided that GPS Navigation Mode is engaged, GPS is the active navigation source on the CDI, and the DME arc segment is the active flight plan leg. It is important to note that automatic navigation of DME arcs is based on GPS. Thus, even if the APR key is pressed and LOC or VOR Approach Mode is armed prior to reaching the Initial Approach Fix (IAF), Approach Mode will not activate until the arc segment is completed.

If the pilot decides to intercept the arc at a location other than the published IAF (i.e. ATC provides vectors to intercept the arc) and subsequently selects Heading Mode or Roll Mode, the AFCS will not automatically intercept or track the arc unless the pilot activates the arc leg of the flight plan and arms GPS Navigation Mode. The AFCS will not intercept and fly a DME arc before reaching an IAF that defines the beginning of the arc segment. Likewise, if at any point while established on the DME arc the pilot deselects GPS Navigation Mode, the AFCS will no longer track the arc.

## 7.5 AUTOPILOT OPERATION

**NOTE:** Refer to the AFM for specific instructions regarding emergency procedures.

The autopilot operates flight control surface servos to provide automatic flight control. Pitch and roll commands are provided to the servos, based on the active flight director modes. The autopilot uses pitch and roll rates to stabilize the aircraft attitude during upsets and flight director maneuvers. Flight director commands are rate- and attitude-limited, combined with pitch and roll damper control, and sent to the pitch and roll servo motors.

Pitch autotrim provides trim commands to the pitch trim servo to relieve any sustained effort required by the pitch servo. The pitch servo measures the output effort (torque) and provides this signal to the pitch trim servo. The pitch trim servo commands the motor to reduce the average pitch servo effort.

When the autopilot is not engaged, the pitch trim servo may be used to provide manual electric trim (MET). This allows the aircraft to be trimmed using a control wheel switch rather than the trim wheel. Manual trim commands are generated only when both halves of the **AP TRIM** Switch are operated simultaneously. Trim speeds are scheduled with airspeed to provide more consistent response.

Servo motor control limits the maximum servo speed and torque. The servo mounts are equipped with slip-clutches set to certain values. This allows the servos to be overridden in case of an emergency.

### ENGAGING THE AUTOPILOT

**NOTE:** Autopilot engagement/disengagement is not equivalent to servo engagement/disengagement. Use the **CWS** Button to disengage the pitch and roll servos while the autopilot remains active.

When the **AP** Key is pressed, the autopilot and flight director (if not already engaged) are activated. Engagement is indicated by a green ‘AP’ annunciation in the center of the AFCS Status Box. The flight director engages in Pitch and Roll Hold modes when initially activated.

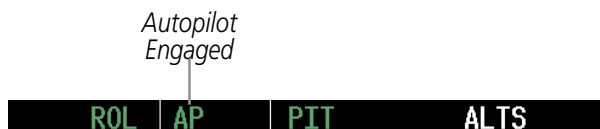

Figure 7-26 Autopilot and Yaw Damper Engaged

- SYSTEM OVERVIEW
- FLIGHT INSTRUMENTS
- EIS
- AUDIO PANEL & CNS
- FLIGHT MANAGEMENT
- HAZARD AVOIDANCE
- AFCS
- ADDITIONAL FEATURES
- APPENDICES
- INDEX

## CONTROL WHEEL STEERING

During autopilot operation, the aircraft may be hand-flown without disengaging the autopilot. Pressing and holding the **CWS** Button disengages the pitch and roll servos from the flight control surfaces and allows the aircraft to be hand-flown. At the same time, the flight director is synchronized to the aircraft attitude during the maneuver. The ‘AP’ annunciation is temporarily replaced by ‘CWS’ in white for the duration of CWS maneuvers.

In most scenarios, releasing the **CWS** Button reengages the autopilot with a new reference. Refer to the flight director modes section for specific CWS behavior in each mode.



Figure 7-27 CWS Annunciation

## DISENGAGING THE AUTOPILOT

The autopilot is manually disengaged by pushing the **AP DISC** Switch, **GA** Switch, **AP TRIM** ARM Switch, or the **AP** Key on the MFD. Manual disengagement is indicated by a five-second flashing yellow ‘AP’ annunciation and a two-second autopilot disconnect aural alert. After manual disengagement, the autopilot disconnect aural alert may be cancelled by pushing the **AP TRIM** ARM or **AP DISC** Switch (**AP DISC** Switch also cancels the flashing ‘AP’ annunciation).



Figure 7-28 Manual Autopilot Disengagement

Automatic autopilot disengagement is indicated by a flashing red ‘AP’ annunciation and by the autopilot disconnect aural alert, which continue until acknowledged by pushing the **AP DISC** or **AP TRIM** ARM Switch. Automatic disengagement occurs due to:

- System failure
- Invalid sensor data
- Inability to compute default flight director modes (FD also disengages automatically)



Figure 7-29 Automatic Autopilot Disengagement

## 7.6 EXAMPLE FLIGHT PLAN



**NOTE:** The following example flight plan and diagrams (not to be used for navigation) in this section are for instructional purposes only and should be considered not current. Numbered portions of accompanying diagrams correspond to numbered procedure steps.

This scenario-based set of procedures (based on the example flight plan found in the Flight Management Section) shows various GFC 700 AFCS modes used during a flight. In this scenario, the aircraft departs Charles B. Wheeler Downtown Airport (KMKC), enroute to Colorado Springs Airport (KCOS). After departure, the aircraft climbs to 12,000 ft and airway V4 is intercepted, following ATC vectors.

Airway V4 is flown to Salina VOR (SLN) using VOR navigation, then airway V244 is flown using GPS navigation. The ILS approach for runway 35L and LPV (WAAS) approach for runway 35R are shown and a missed approach is executed.

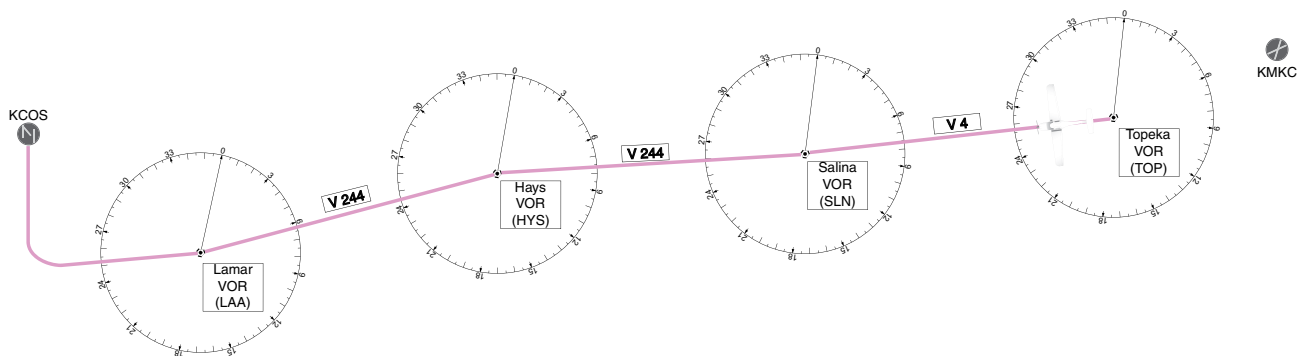

Figure 7-30 Flight Plan Overview

- SYSTEM OVERVIEW
- FLIGHT INSTRUMENTS
- EIS
- AUDIO PANEL & CNS
- FLIGHT MANAGEMENT
- HAZARD AVOIDANCE
- AFCS
- ADDITIONAL FEATURES
- APPENDICES
- INDEX

DEPARTURE

**Climbing to the Selected Altitude and flying an assigned heading:**

- 1) Before takeoff, set the Selected Altitude to 12,000 feet using the **ALT** Knob.
- 2) In this example, Vertical Speed Mode is used to capture the Selected Altitude (Pitch Hold, Vertical Speed, or Flight Level Change Mode may be used).
  - a) Press the **VS** Key to activate Vertical Speed Mode.

ROL | VS ↑ 500<sub>FPM</sub> ALTS

The Vertical Speed Reference may be adjusted after Vertical Speed Mode is selected using the **NOSE UP/NOSE DN** Keys or pushing the **CWS** Button while hand-flying the aircraft to establish a new Vertical Speed Reference.

- b) Press the **AP** Key to engage the autopilot in a climb using Vertical Speed Mode.

ROL | AP | VS ↑ 500<sub>FPM</sub> ALTS

- 3) Use the **HDG** Knob to set the Selected Heading, complying with ATC vectors to intercept Airway V4.  
Press the **HDG** Key to activate Heading Select Mode while the autopilot is engaged in the climb. The autopilot follows the Selected Heading Bug on the HSI and turns the aircraft to the desired heading.

HDG | AP | VS ↑ 500<sub>FPM</sub> ALTS

- 4) As the aircraft nears the Selected Altitude, the flight director transitions to Selected Altitude Capture Mode, indicated by the green 'ALTS' annunciation flashing for up to 10 seconds.

HDG | AP | ALTS 12000<sub>FT</sub> ALT

At 50 feet from the Selected Altitude, the green 'ALT' annunciation flashes for up to 10 seconds; the autopilot transitions to Altitude Hold Mode and levels the aircraft.

HDG | AP | ALT 12000<sub>FT</sub>

- SYSTEM OVERVIEW
- FLIGHT INSTRUMENTS
- EIS
- AUDIO PANEL & CNS
- FLIGHT MANAGEMENT
- HAZARD AVOIDANCE
- AFCS**
- ADDITIONAL FEATURES
- APPENDICES
- INDEX

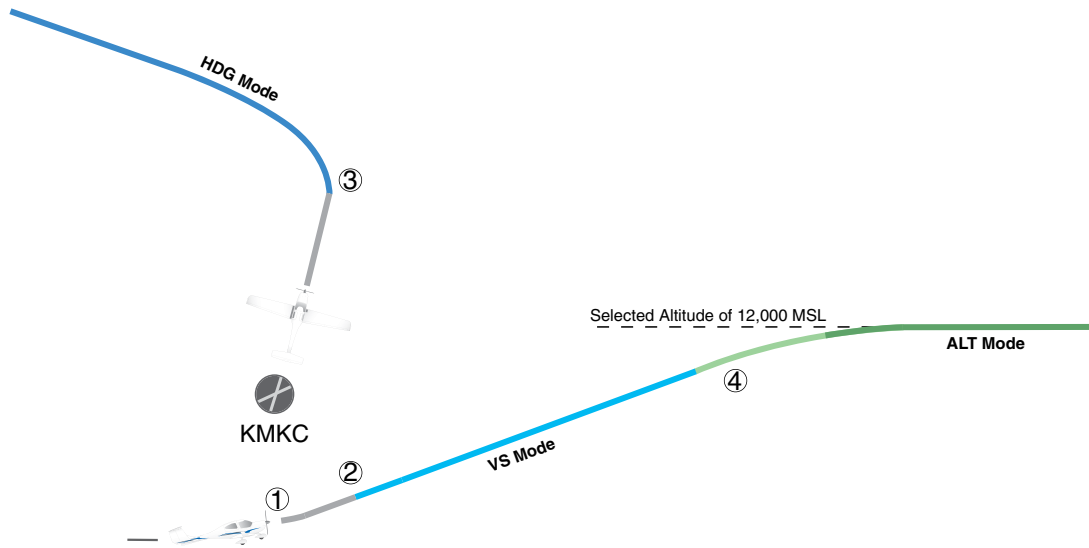

Figure 7-31 Departure

**INTERCEPTING A VOR RADIAL**

During climb-out, the autopilot continues to fly the aircraft in Heading Select Mode. Airway V4 to Salina VOR (SLN) should now be intercepted. Since the enroute flight plan waypoints correspond to VORs, flight director Navigation Mode using either VOR or GPS as the navigation source may be used. In this scenario, VOR Navigation Mode is used for navigation to the first VOR waypoint in the flight plan.

**Intercepting a VOR radial:**

- 1) Arm VOR Navigation Mode:
  - a) Tune the VOR frequency.
  - b) Press the **CDI** Softkey to set the navigation source to VOR.
  - c) Use the **CRS** Knob to set the Selected Course to 255°. Note that at this point, the flight director is still in Heading Select Mode and the autopilot continues to fly 290°.
  - d) Press the **NAV** Key. This arms VOR Navigation Mode and the white 'VOR' annunciation appears to the left of the active lateral mode.



- 2) As the aircraft nears the Selected Course, the flight director transitions from Heading Select to VOR Navigation Mode and the 'VOR' annunciation flashes green. The autopilot begins turning to intercept the Selected Course.



- 3) The autopilot continues the turn until the aircraft is established on the Selected Course.

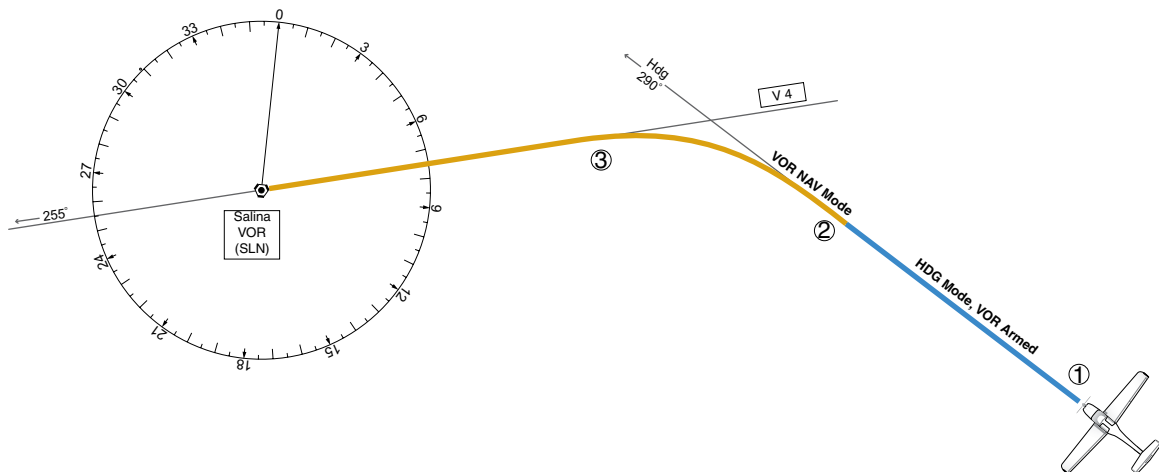

**Figure 7-32 Intercepting a VOR Radial**



## FLYING A FLIGHT PLAN/GPS COURSE

**NOTE:** Changing the navigation source cancels Navigation Mode and causes the flight director to revert back to Roll Hold Mode (wings rolled level).

As the aircraft closes on Salina VOR, GPS is used to navigate the next leg, airway V244. The aircraft is currently tracking inbound on Airway V4.

### Flying a GPS flight plan:

- 1) Transition from VOR to GPS Navigation Mode:
  - a) Press the **CDI** Softkey until GPS is the selected navigation source.
  - b) Press the **NAV** Key to activate GPS Navigation Mode. The autopilot guides the aircraft along the active flight plan leg.



- 2) Following the flight plan, the autopilot continues to steer the aircraft under GPS guidance. Note that in GPS Navigation Mode, course changes defined by the flight plan are automatically made without pilot action required.

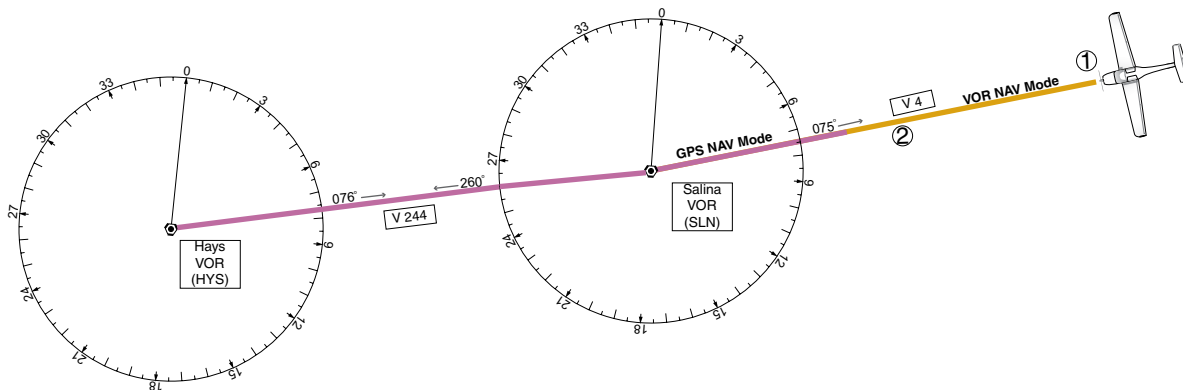

Figure 7-33 Transition to GPS Flight Plan

DESCENT

While flying the arrival procedure, the aircraft is cleared for descent in preparation for the approach to KCOS. Three methods are presented for the descent:

- Flight Level Change descent – Flight Level Change Mode can be used to descend to the Selected Altitude at a constant airspeed. This descent method does not account for flight plan waypoint altitude constraints.
- Vertical Path Tracking descent – Vertical Path Tracking Mode is used to follow the vertical descent path defined in the GPS flight plan. Altitude constraints correspond to waypoints in the flight plan. Before VNV flight control can provide vertical profile guidance, a VNV flight plan must be entered and enabled.
- Non-path descent in a VNV scenario – A VNV flight plan is entered and enabled, however Pitch Hold, Vertical Speed, or Flight Level Change Mode can be used to descend to the VNV Target Altitude prior to reaching the planned TOD. Flight Level Change Mode is used in the example.

Flight Level Change descent:

- 1) Select Flight Level Change Mode:
  - a) Using the **ALT** Knob, set the Selected Altitude to 10,000 feet.
  - b) Press the **FLC** Key to activate Flight Level Change Mode. The annunciation 'FLC' appears next to the Airspeed Reference, which defaults to the current aircraft airspeed. Selected Altitude Capture Mode is armed automatically.



- 2) Use the **NOSE UP/NOSE DN** Keys or push the **CWS** Button while hand-flying the aircraft to adjust the commanded airspeed while maintaining the same power, or reduce power to allow descent in Flight Level Change Mode while the autopilot maintains the current airspeed.
- 3) As the aircraft nears the Selected Altitude, the flight director transitions to Selected Altitude Capture Mode, indicated by the green 'ALTS' annunciation flashing for up to 10 seconds.



The green 'ALT' annunciation flashes for up to 10 seconds upon reaching 50 feet from the Selected Altitude; the autopilot transitions to Altitude Hold Mode and levels the aircraft.

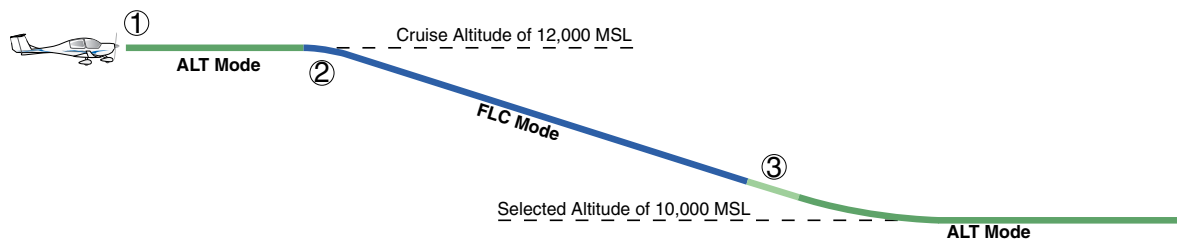

Figure 7-34 FLC Descent

**Vertical Path Tracking descent to VNV Target Altitude:**

1) Select VNV flight control:

a) Press the **VNV** Key to arm Vertical Path Tracking Mode. The white annunciation 'VPTH' appears.



b) Using the **ALT** Knob, set the Selected Altitude below the flight plan's VNV Target Altitude of 10,000 feet.

If the Selected Altitude is not at least 75 ft below the VNV Target Altitude, the flight director captures the Selected Altitude rather than the VNV Target Altitude once Vertical Path Tracking Mode becomes active (ALTS is armed rather than ALT).

c) If Vertical Path Tracking Mode is armed more than 5 minutes prior to descent path capture, acknowledgment is required for the flight director to transition from Altitude Hold to Vertical Path Tracking Mode. To proceed with descent path capture if the white 'VPTH' annunciation begins flashing, do one of the following

- Press the **VNV** Key
- Turn the **ALT** Knob to adjust the Selected Altitude

If the descent is not confirmed by the time of interception, Vertical Path Tracking Mode remains armed and the descent is not captured.

2) When the top of descent (TOD) is reached, the flight director transitions to Vertical Path Tracking Mode and begins the descent to the VNV Target Altitude. Intention to capture the VNV Target Altitude is indicated by the white 'ALT' annunciation.



3) As the aircraft nears the VNV Target Altitude, the flight director transitions to VNV Target Altitude Capture Mode, indicated by the green 'ALT' annunciation flashing for up to 10 seconds.



The green 'ALT' annunciation flashes for up to 10 seconds upon reaching 50 feet from the VNV Target Altitude; the autopilot transitions to Altitude Hold Mode and levels the aircraft at the vertical waypoint.

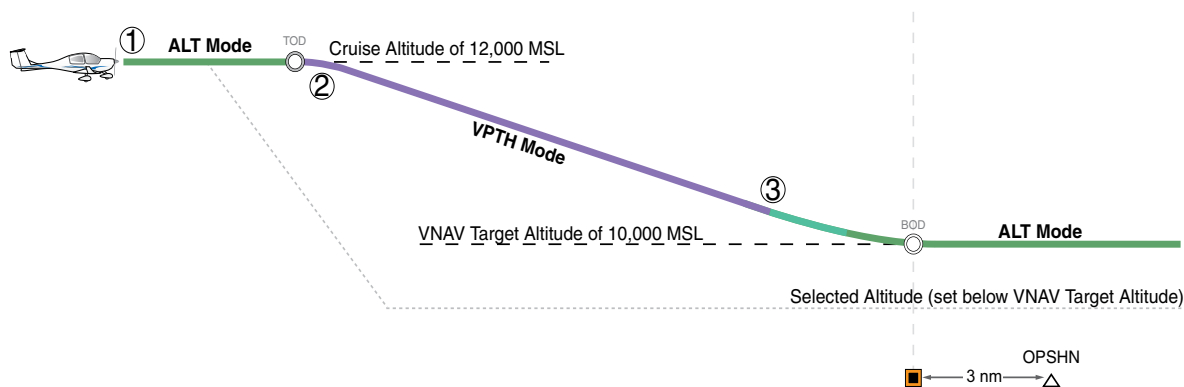

**Figure 7-35 VPTH Descent**

**Non-path descent using Flight Level Change Mode:**

- 1) Using Flight Level Change Mode, command a non-path descent to an intermediate altitude above the next VNV flight plan altitude:
  - a) Using the **ALT** Knob, set the Selected Altitude below the current aircraft altitude to an altitude (in this case 9,400 feet) at which to level off between VNV flight plan altitudes.
  - b) Press the **FLC** Key before the planned TOD during an altitude hold while VPTH is armed. The Airspeed Reference defaults to the current aircraft airspeed. Vertical Path Tracking and Selected Altitude Capture Mode are armed automatically.

GPS | AP | FLC | 130KT | **ALTS** | VPTH

- 2) Reduce power to allow descent in Flight Level Change Mode. The autopilot maintains the Airspeed Reference.
- 3) As the aircraft nears the Selected Altitude, the flight director transitions to Selected Altitude Capture Mode, indicated by the green 'ALTS' annunciation flashing for up to 10 seconds.

GPS | AP | **ALTS** | 9400FT | ALT | VPTH

The green 'ALT' annunciation flashes for up to 10 seconds upon reaching 50 feet from the Selected Altitude; the autopilot transitions to Altitude Hold Mode and levels the aircraft. After leveling off, reset Selected Altitude at or below 9,000 ft.

GPS | AP | **ALT** | 9400FT | VPTH

- 4) When the next TOD is reached, Vertical Path Tracking becomes active (may require acknowledgment to allow descent path capture).

GPS | AP | VPTH | **ALTV**

- 5) As the aircraft nears the VNV Target Altitude, the flight director transitions to VNV Target Altitude Capture Mode, indicated by the green 'ALTV' annunciation flashing for up to 10 seconds.

GPS | AP | **ALTV** | 9000FT | ALT

The green 'ALT' annunciation flashes for up to 10 seconds upon reaching 50 feet from the VNV Target Altitude; the autopilot transitions to Altitude Hold Mode and levels the aircraft at the vertical waypoint.

GPS | AP | **ALT** | 9000FT

- SYSTEM OVERVIEW
- FLIGHT INSTRUMENTS
- EIS
- AUDIO PANEL & CNS
- FLIGHT MANAGEMENT
- HAZARD AVOIDANCE
- AFCS
- ADDITIONAL FEATURES
- APPENDICES
- INDEX

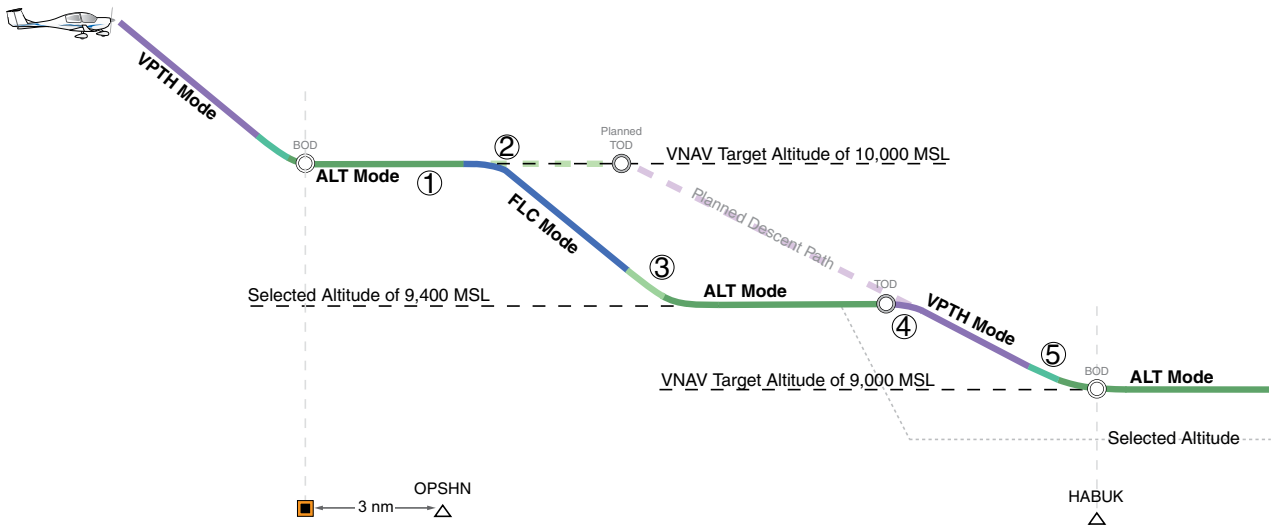

Figure 7-36 Non-path Descent

APPROACH

Flying an ILS approach:

- 1) Transition from GPS Navigation Mode to Heading Select Mode.
  - a) Select the Runway 35L ILS approach for KCOS and select 'VECTORS' for the transition. Load and activate the approach into the flight plan.
  - b) Use the **HDG** Knob to set the Selected Heading after getting vectors from ATC.
  - c) Press the **HDG** Key. The autopilot turns the aircraft to the desired heading.
  - d) Use Heading Select Mode to comply with ATC vectors as requested.



- 2) Arm LOC Approach and Glideslope modes.
  - a) Ensure the appropriate localizer frequency is tuned.
  - b) Press the **APR** Key when cleared for approach to arm Approach and Glideslope modes. 'LOC' and 'GS' appear in white as armed mode annunciations.



- c) The navigation source automatically switches to LOC. After this switch occurs, the localizer signal can be captured and the flight director determines when to begin the turn to intercept the final approach course. The flight director now provides guidance to the missed approach point.
- 3) There are two options available at this point, as the autopilot flies the ILS approach:
  - Push the **AP DISC** Switch at the decision height and land the aircraft.
  - Use the **GA** Switch to execute a missed approach.

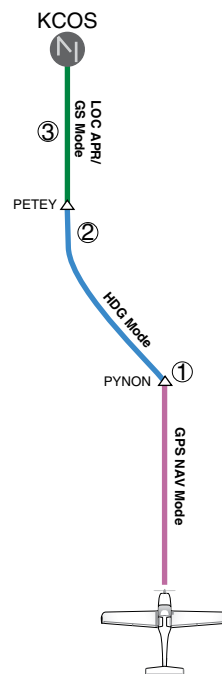

Figure 7-37 ILS Approach to KCOS



**NOTE:** Refer to the AFM to determine whether SBAS functionality is approved. Support for SBAS precision approaches is available only in installations with GIA 63Ws when SBAS is available.

### Flying a RNAV GPS approach with vertical guidance:

- 1) Arm flight director modes for a RNAV GPS approach with vertical guidance:
  - a) Make sure the navigation source is set to GPS (use **CDI** Softkey to change navigation source).
  - b) Select the Runway 35R LPV approach for KCOS. Load and activate the approach into the flight plan.
- 2) Press the **APR** Key once clearance for approach has been received. GPS Approach Mode is activated and Glidepath Mode is armed.



- 3) Once the glidepath is captured, Glidepath Mode becomes active. The flight director now provides guidance to the missed approach point.



- 4) There are two options available at this point, as the autopilot flies the approach:
  - Push the **AP DISC** Switch at the Decision height and land the aircraft.
  - Use the **GA** Switch to execute a missed approach.

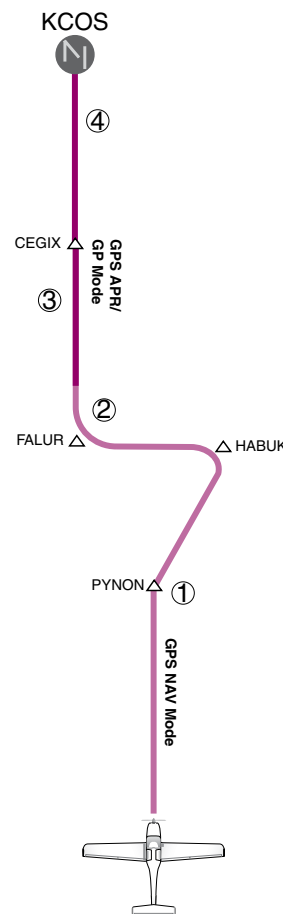

Figure 7-38 LPV Approach to KCOS



GO AROUND/MISSED APPROACH



**NOTE:** As a result of calculations performed by the system while flying the holding pattern, the display may re-size automatically and the aircraft may not precisely track the holding pattern as depicted on the PFD and MFD.

Flying a missed approach:

- 1) Push the **GA** Switch at the Decision Height and apply go around power to execute a missed approach. The flight director Command Bars establish a nose-up climb to follow. If flying an ILS or LOC approach the CDI also switches to GPS as the navigation source.

Note that when the **GA** Switch is pushed, the missed approach is activated and the autopilot disconnects, indicated by the 'AP' annunciation flashing yellow for 5 seconds.

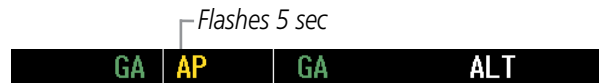

- 2) Start the climb to the prescribed altitude in the published Missed Approach Procedure (in this case, 10,000 ft).
  - a) Press the **AP** Key to re-engage the autopilot.
  - b) Press the **NAV** Key to have the autopilot fly to the hold.



- 3) Use the **ALT** Knob to set a Selected Altitude to hold.

To hold the current airspeed during the climb, press the **FLC** Key.



As the aircraft nears the Selected Altitude, the flight director transitions to Selected Altitude Capture Mode, indicated by the green 'ALTS' annunciation flashing for up to 10 seconds.



The green 'ALT' annunciation flashes for up to 10 seconds upon reaching 50 feet from the Selected Altitude; the autopilot transitions to Altitude Hold Mode and levels the aircraft.



- 4) The autopilot flies the holding pattern after the missed approach is activated. Annunciations are displayed in the Navigation Status Box, above the AFCS Status Box.



SYSTEM OVERVIEW

FLIGHT INSTRUMENTS

EIS

AUDIO PANEL & CNS

FLIGHT MANAGEMENT

HAZARD AVOIDANCE

AFCS

ADDITIONAL FEATURES

APPENDICES

INDEX

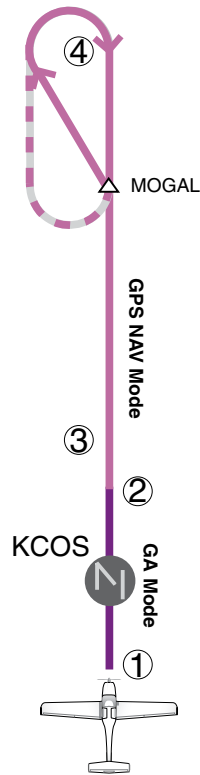

Figure 7-39 Go Around/Missed Approach

## 7.7 AFCS ANNUNCIATIONS AND ALERTS

### AFCS STATUS ALERTS

The annunciations in Table 7-5 (listed in order of increasing priority) can appear on the PFD above the Airspeed and Attitude indicators. Only one annunciation may occur at a time, and messages are prioritized by criticality.

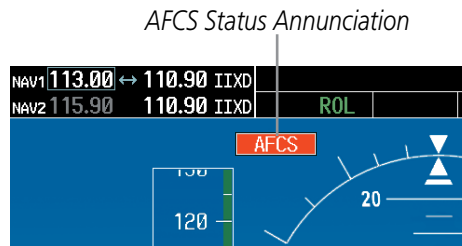

Figure 7-40 AFCS Status Annunciation

Alert Condition	Annunciation	Description
Aileron Mistrim Right	<b>AIL→</b>	Roll servo providing sustained force in the indicated direction
Aileron Mistrim Left	<b>←AIL</b>	
Elevator Mistrim Down	<b>↓ELE</b>	Pitch servo providing sustained force in the indicated direction
Elevator Mistrim Up	<b>↑ELE</b>	
Pitch Trim Failure (or stuck <b>AP TRIM</b> Switch)	<b>PTRM</b>	If AP engaged, take control of the aircraft and disengage AP If AP disengaged, move <b>AP TRIM</b> switches separately to unstick
Roll Failure	<b>ROLL</b>	Roll axis control failure; AP inoperative
Pitch Failure	<b>PTCH</b>	Pitch axis control failure; AP inoperative
System Failure	<b>AFCS</b>	AP and MET are unavailable; FD may still be available
Preflight Test	<b>PFT</b>	Performing preflight system test; aural alert sounds at completion Do not press the <b>AP DISC</b> Switch during servo power-up and preflight system tests as this may cause the preflight system test to fail or never to start (if servos fail their power-up tests). Power must be cycled to the servos to remedy the situation.
	<b>PFT</b>	Preflight system test failed; aural alert sounds at failure

Table 7-5 AFCS Status Field Alerts

## OVERSPEED PROTECTION

**NOTE:** Overspeed protection is not active in Altitude Hold, Glideslope or Glidepath Modes.

While Pitch Hold, Vertical Speed, Flight Level Change, Vertical Path Tracking, or an altitude capture mode is active, airspeed is monitored by the flight director and pitch commands are limited for overspeed protection. Overspeed protection is provided in situations where the flight director cannot acquire and maintain the mode reference for the selected vertical mode without exceeding the certified maximum autopilot airspeed.

When an autopilot overspeed condition occurs, the Airspeed Reference appears in a box above the Airspeed Indicator, flashing a yellow 'MAXSPD' annunciation. Engine power should be reduced and/or the pitch reference adjusted to slow the aircraft. The annunciation disappears when the overspeed condition is resolved.

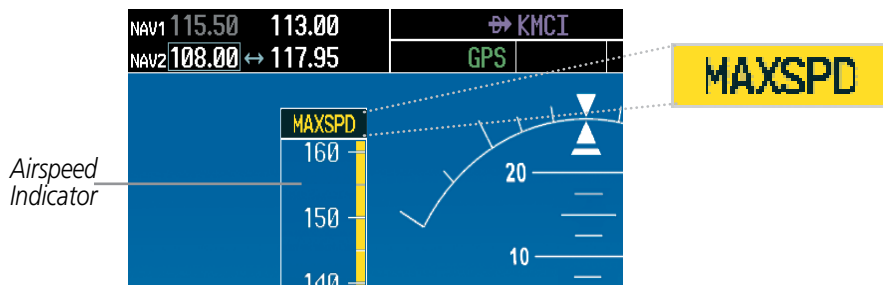

Figure 7-41 Overspeed Annunciation

## ANNUNCIATIONS FOR KAP 140 AUTOPILOT SYSTEM

**NOTE:** Refer to the autopilot manufacturer's Pilot's Guide for more information.

When GPS approach mode becomes active and the necessary approach criteria are met, a message appears in the AFCS Status Box alerting the pilot to a change in autopilot NAV source ("NAV Source Changed – Select Desired Autopilot Mode"). The annunciation shall blink for five seconds and remain in the AFCS Status Box for 30 seconds.



Figure 7-42 KAP 140 Annunciation (Informative)

**NOTE: KAP 140 equipped aircraft only:** Each time the CDI Softkey is pressed or the navigation source is changed (i.e. missed approach), the following message appears in the message window, "NAV Source Changed – Select Desired Autopilot Mode."

## SECTION 8 ADDITIONAL FEATURES



**NOTE:** *With the availability of SafeTaxi®, ChartView, or FliteCharts®, it may be necessary to carry another source of charts on-board the aircraft.*

Additional features of the system include the following:

- Synthetic Vision System (SVS) (optional)
- SafeTaxi® diagrams
- ChartView and FliteCharts® electronic charts
- AOPA's Airport Directory
- SiriusXM Satellite Radio entertainment (optional)
- Scheduler
- Electronic Checklists (optional)
- Flight Data Logging
- Auxiliary Video (optional)

The optional Synthetic Vision System (SVS) provides a three-dimensional forward view of terrain features on the PFD. SVS imagery shows the pilot's view of relevant features in relation to the aircraft attitude, as well as the flight path pertaining to the active flight plan.

SafeTaxi diagrams provide detailed taxiway, runway, and ramp information at more than 700 airports in the United States. By decreasing range on an airport that has a SafeTaxi diagram available, a close up view of the airport layout can be seen.

The optional ChartView and FliteCharts provide on-board electronic terminal procedures charts. Electronic charts offer the convenience of rapid access to essential information. Either ChartView or FliteCharts may be configured in the system, but not both.

AOPA's Airport Directory offers detailed information for a selected airport, such as available services, hours of operation, and lodging options.

The optional SiriusXM Satellite Radio entertainment audio feature of the GDL 69A Data Link Receiver handles more than 170 channels of music, news, and sports. SiriusXM Satellite Radio offers more entertainment choices and longer range coverage than commercial broadcast stations.

The Scheduler feature can be used to enter and display short term or long term reminder messages such as Switch fuel tanks, Change oil, or Altimeter-Transponder Check in the Alerts Window on the PFD.

Optional checklists help to quickly find the proper procedure on the ground or during flight.

The Flight Data Logging feature automatically stores critical flight and engine data on an SD data card. Approximately 1,000 flight hours can be recorded for each 1GB of available space on the card.

The G1000 system provides a control and display interface to an optional auxiliary video system.

## 8.1 SYNTHETIC VISION SYSTEM (SVS) (OPTIONAL)



**WARNING:** Use appropriate primary systems for navigation, and for terrain, obstacle, and traffic avoidance. SVS is intended as an aid to situational awareness only and may not provide either the accuracy or reliability upon which to solely base decisions and/or plan maneuvers to avoid terrain, obstacles, or traffic.

The optional Synthetic Vision System (SVS) is a visual enhancement to the G1000 Integrated Flight Deck. SVS depicts a forward-looking attitude display of the topography immediately in front of the aircraft. The field of view is 30 degrees to the left and 35 degrees to the right. SVS information is shown on the Primary Flight Display (PFD), or on the Multifunction Display (MFD) in Reversionary Mode (Figure 8-88). The depicted imagery is derived from the aircraft attitude, heading, GPS three-dimensional position, and a nine arc-second database of terrain, obstacles, and other relevant features. The terrain data resolution of nine arc-seconds, meaning that the terrain elevation contours are stored in squares measuring nine arc-seconds on each side, is required for the operation of SVS. Loss of any of the required data, including temporary loss of the GPS signal, will cause SVS to be disabled until the required data is restored.

The SVS terrain display shows land contours (colors are consistent with those of the topographical map display), large water features, towers, and other obstacles over 200' AGL that are included in the obstacle database. Cultural features on the ground such as roads, highways, railroad tracks, cities, and state boundaries are not displayed even if those features are found on the MFD map. The terrain display also includes a north–south east–west grid with lines oriented with true north and spaced at one arc-minute intervals to assist in orientation relative to the terrain.

Terrain-SVS is integrated within SVS to provide visual and auditory alerts to indicate the presence of terrain and obstacle threats relevant to the projected flight path. Terrain alerts are displayed in red and yellow shading on the PFD.

The terrain display is intended for situational awareness only. It may not provide the accuracy or fidelity on which to base decisions and plan maneuvers to avoid terrain or obstacles. Navigation must not be predicated solely upon the use of the Terrain–SVS terrain or obstacle data displayed by the SVS.

The following SVS enhancements appear on the PFD:

- Pathways
- Flight Path Marker
- Horizon Heading Marks
- Traffic Display
- Airport Signs
- Runway Display
- Terrain Alerting
- Obstacle Alerting



Figure 8-1 Synthetic Vision Imagery

## SVS OPERATION

SVS is activated from the PFD using the softkeys located along the bottom edge of the display. Pressing the softkeys turns the related function on or off. When SVS is enabled, the pitch scale increments are reduced to 10 degrees up and 7.5 degrees down.

SVS functions are displayed on three levels of softkeys. The **PFD** Softkey leads into the PFD function Softkeys, including synthetic vision. Pressing the **SYN VIS** Softkey displays the SVS feature softkeys. The softkeys are labeled **PATHWAY**, **SYN TERR**, **HRZN HDG**, and **APTSIGNS**. The **BACK** Softkey returns to the previous level of softkeys. Synthetic Terrain must be active before any other SVS feature may be activated.

**HRZN HDG**, **APTSIGNS**, and **PATHWAY** Softkeys are only available when the **SYN TERR** Softkey is activated (gray with black characters). After activating the **SYN TERR** Softkey, the **HRZN HDG**, **APTSIGNS**, and **PATHWAY** softkeys may be activated in any combination to display desired features. When system power is cycled, the last selected state (on or off) of the **SYN TERR**, **HRZN HDG**, **APTSIGNS**, and **PATHWAY** softkeys is remembered by the system.

- **PATHWAY** Softkey enables display of rectangular boxes that represent course guidance.
- **SYN TERR** Softkey enables synthetic terrain depiction.
- **HRZN HDG** Softkey enables horizon heading marks and digits.
- **APTSIGNS** Softkey enables airport signposts.



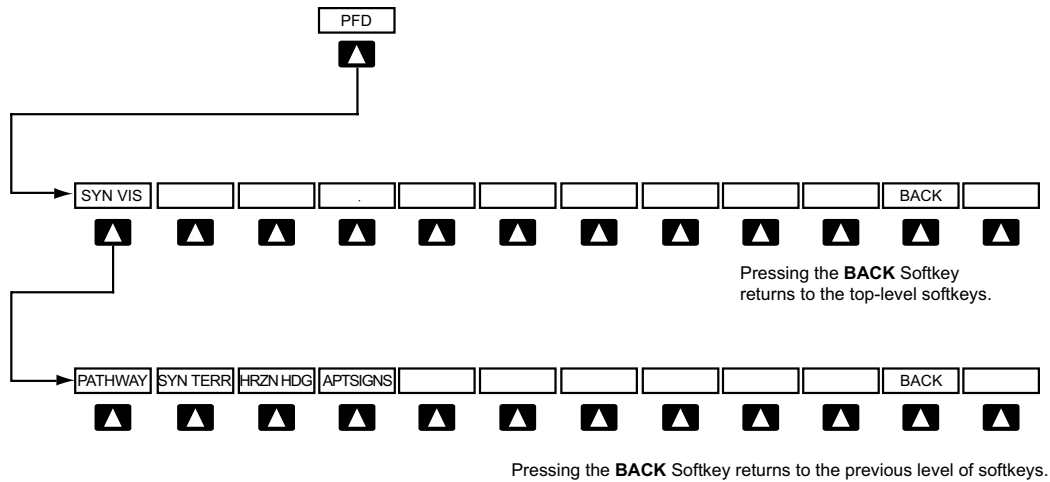

Figure 8-2 SVS Softkeys

**Activating and deactivating SVS:**

- 1) Press the **PFD** Softkey.
- 2) Press the **SYN VIS** Softkey.
- 3) Press the **SYN TERR** Softkey. The SVS display will cycle on or off with the **SYN TERR** Softkey.

**Activating and deactivating Pathways:**

- 1) Press the **PFD** Softkey.
- 2) Press the **SYN VIS** Softkey.
- 3) Press the **PATHWAY** Softkey. The Pathway feature will cycle on or off with the **PATHWAY** Softkey.

**Activating and deactivating Horizon Headings:**

- 1) Press the **PFD** Softkey.
- 2) Press the **SYN VIS** Softkey.
- 3) Press the **HRZN HDG** Softkey. The horizon heading display will cycle on or off with the **HRZN HDG** Softkey.

**Activating and deactivating Airport Signs:**

- 1) Press the **PFD** Softkey.
- 2) Press the **SYN VIS** Softkey.
- 3) Press the **APTSIGNS** Softkey. Display of airport signs will cycle on or off with the **APTSIGNS** Softkey.

SVS FEATURES



Figure 8-3 SVS on the Primary Flight Display



**NOTE:** Pathways and terrain features are not a substitute for standard course and altitude deviation information provided by the altimeter, CDI, and VDI.

PATHWAYS

Pathways provide a three-dimensional perspective view of the selected route of flight shown as colored rectangular boxes representing the horizontal and vertical flight path of the active flight plan. The box size represents 700 feet wide by 200 feet tall during enroute, oceanic, and terminal flight phases. During an approach, the box width is 700 feet or one half full scale deviation on the HSI, whichever is less. The height is 200 feet or one half full scale deviation on the VDI, whichever is less. The altitude at which the pathway boxes are displayed is determined by the higher of either the selected altitude or the VNAV altitude programmed for the active leg in the flight plan (Figure 8-4).

The color of the rectangular boxes may be magenta, green, or white depending on the route of flight and navigation source selected. The active GPS or GPS overlay flight plan leg is represented by magenta boxes that correspond to the Magenta CDI. A localizer course is represented by green boxes that correspond to a green CDI. An inactive leg of an active flight plan is represented by white boxes corresponding to a white line drawn on the Inset map or MFD map indicating an inactive leg.

- SYSTEM OVERVIEW
- FLIGHT INSTRUMENTS
- EIS
- AUDIO PANEL & CNS
- FLIGHT MANAGEMENT
- HAZARD AVOIDANCE
- AFCS
- ADDITIONAL FEATURES
- APPENDICES
- INDEX

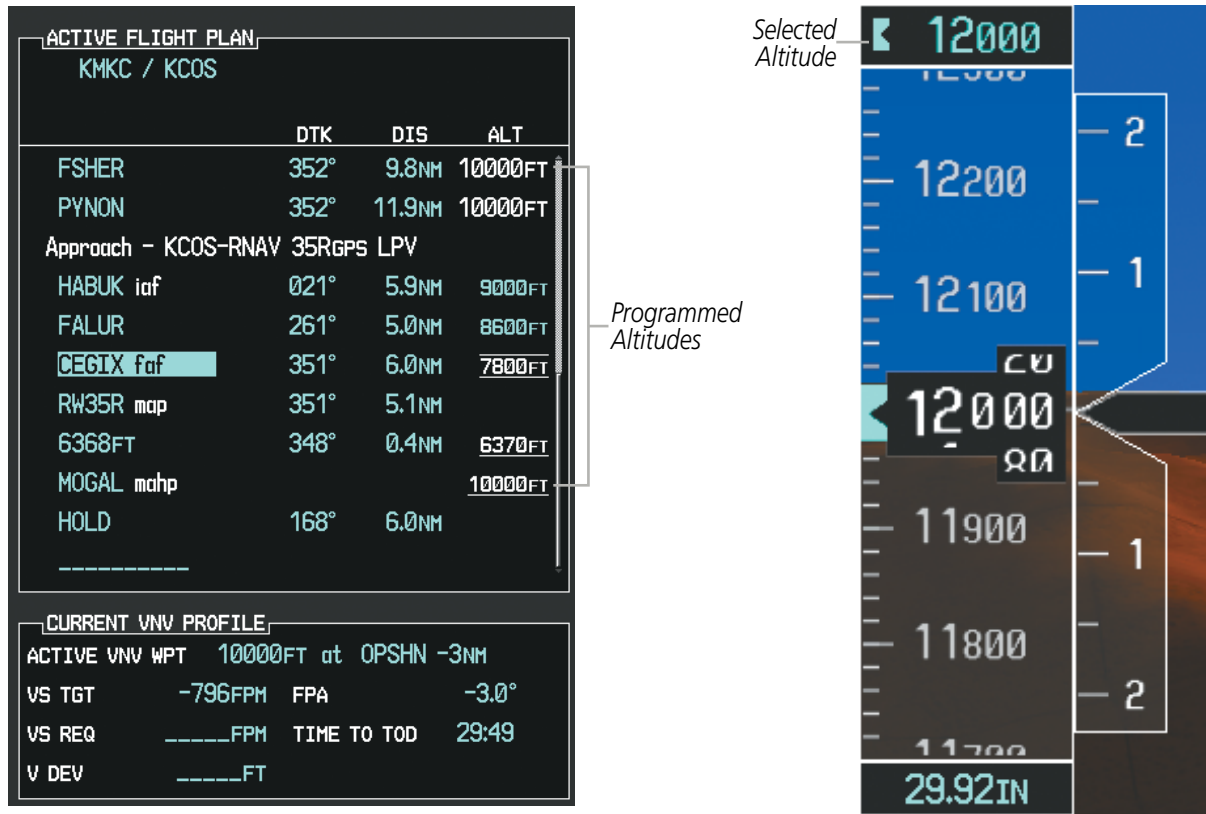

Figure 8-4 Programmed and Selected Altitude

Pathways provide supplemental glidepath information on an active ILS, LPV, LNAV/VNAV, and some LNAV approaches. Pathways are intended as an aid to situational awareness and should not be used independent of the CDI, VDI, glide path indicator, and glide slope indicator. They are removed from the display when the selected navigation information is not available. Pathways are not displayed beyond the active leg when leg sequencing is suspended and are not displayed on any portion of the flight plan leg that would lead to intercepting a leg in the wrong direction.

### DEPARTURE AND ENROUTE

Prior to intercepting an active flight plan leg, pathways are displayed as a series of boxes with pointers at each corner that point in the direction of the active waypoint. Pathways are not displayed for the first leg of the flight plan if that segment is a Heading-to-Altitude leg. The first segment displaying pathways is the first active GPS leg or active leg with a GPS overlay. If this leg of the flight plan route is outside the SVS field of view, pathways will not be visible until the aircraft has turned toward this leg. While approaching the center of the active leg and prescribed altitude, the number of pathway boxes decreases to a minimum of four.

Pathways are displayed along the flight plan route at the highest of either the selected altitude or the programmed altitude for the leg. Climb profiles cannot be displayed due to the variables associated with aircraft performance. Flight plan legs requiring a climb are indicated by pathways displayed at a level above the aircraft at the altitude selected or programmed.

**DESCENT AND APPROACH**

Pathways are shown descending only for a programmed descent (Figures 8-5, 8-6). When the flight plan includes programmed descent segments, pathways are displayed along the descent path provided that the selected altitude is lower than the programmed altitude.

During a Vectors-to-Final (VTF) approach transition, pathways are displayed along the final approach course inbound to the Missed Approach Point (MAP). Pathways are shown level at the selected altitude or at the next programmed crossing altitude, whichever is higher, up to the point along the final approach course where the altitude intercepts the extended vertical descent path, glidepath, or glideslope. From the vertical path descent, glidepath, or glideslope intercept point, the pathways are shown inbound to the Missed Approach Point (MAP) along the published lateral and vertical descent path.

During an ILS approach, the initial approach segment is displayed in magenta at the segment altitudes if GPS is selected as the navigation source on the CDI. When switching to localizer inbound with LOC selected as the navigation source on the CDI, pathways are displayed in green along the localizer and glide slope.

VOR, LOC BC, and ADF approach segments that are approved to be flown using GPS are displayed in magenta boxes. Segments that are flown using other than GPS or ILS, such as heading legs or VOR final approach courses are not displayed.

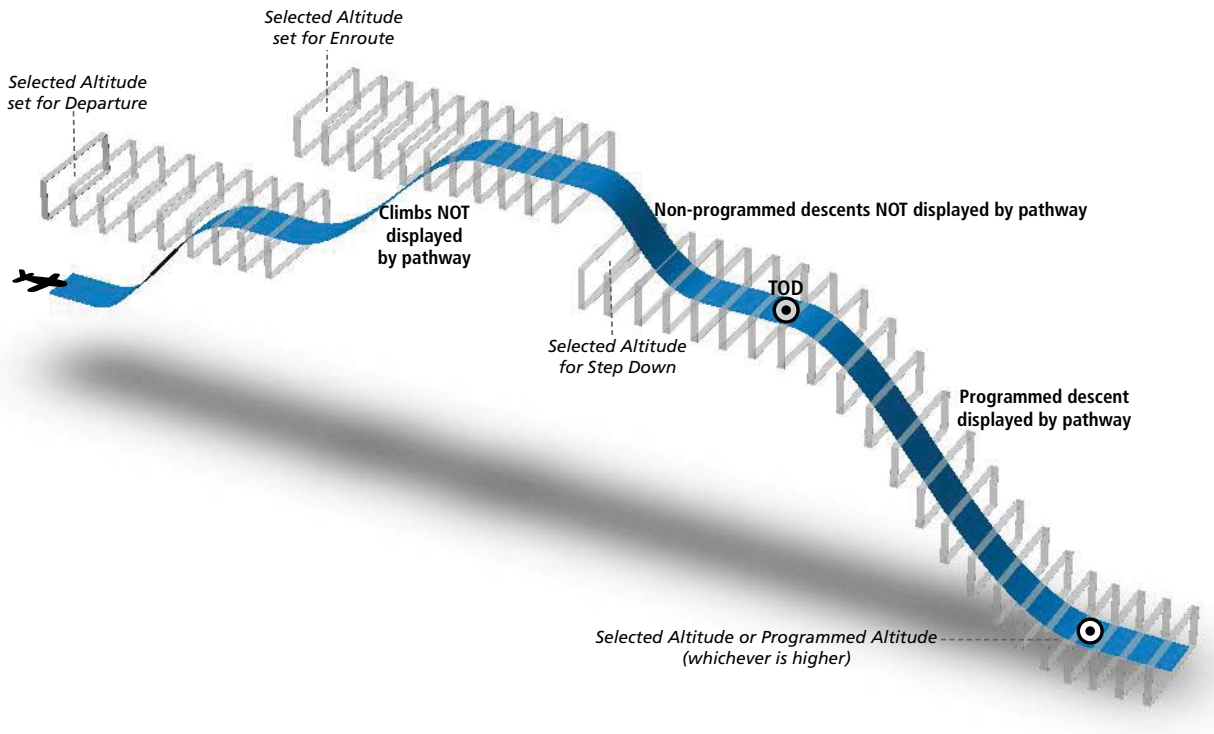

Figure 8-5 SVS Pathways, Enroute and Descent

- SYSTEM OVERVIEW
- FLIGHT INSTRUMENTS
- EIS
- AUDIO PANEL & CNS
- FLIGHT MANAGEMENT
- HAZARD AVOIDANCE
- AFCS
- ADDITIONAL FEATURES
- APPENDICES
- INDEX

**MISSED APPROACH**

Upon activating the missed approach, pathways lead to the Missed Approach Holding Point (MAHP) and are displayed as a level path at the published altitude for the MAHP, or the selected altitude, whichever is the highest. If the initial missed approach leg is a Course-to-Altitude (CA) leg, the pathways boxes will be displayed level at the altitude published for the MAHP. If the initial missed approach leg is defined by a course using other than GPS, pathways are not displayed for that segment. In this case, the pathways displayed for the next leg may be outside the field of view and will be visible when the aircraft has turned in the direction of that leg.

Pathways are displayed along each segment including the path required to track course reversals that are part of a procedure, such as holding patterns. Pathways boxes will not indicate a turn to a MAHP unless a defined geographical waypoint exists between the MAP and MAHP.

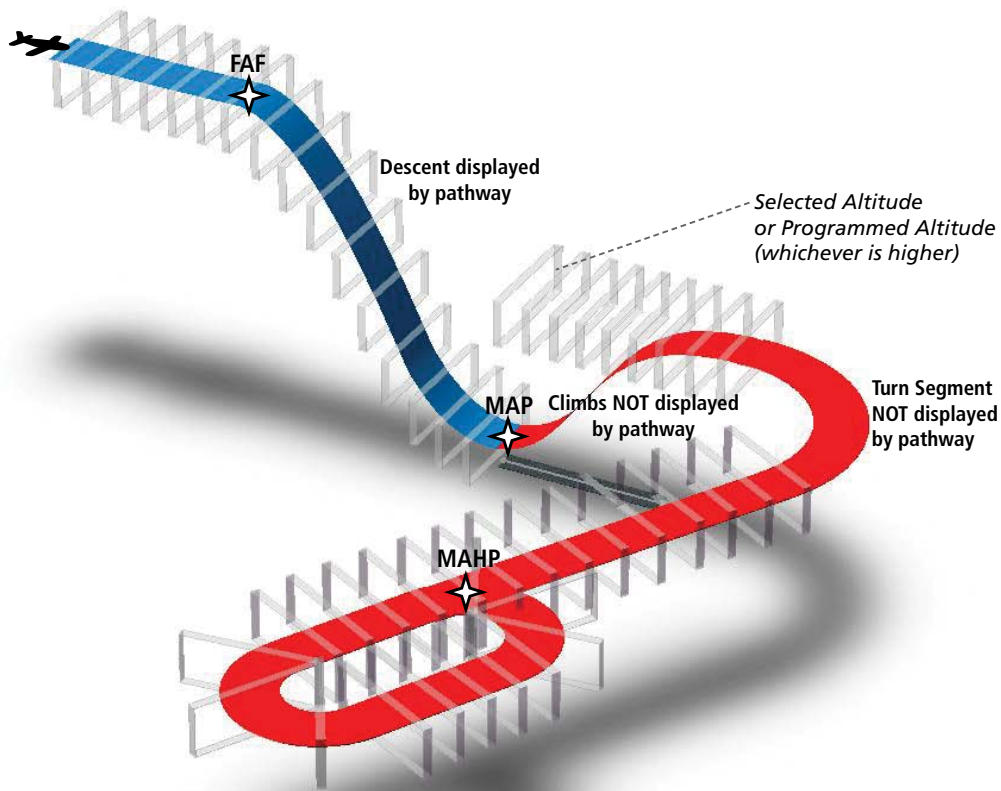

Figure 8-6 SVS Pathways, Approach, Missed Approach, and Holding

- SYSTEM OVERVIEW
- FLIGHT INSTRUMENTS
- EIS
- AUDIO PANEL & CNS
- FLIGHT MANAGEMENT
- HAZARD AVOIDANCE
- AFCS
- ADDITIONAL FEATURES
- APPENDICES
- INDEX



## FLIGHT PATH MARKER

The Flight Path Marker (FPM), also known as a Velocity Vector, is displayed on the PFD at groundspeeds above 30 knots. The FPM depicts the approximate projected path of the aircraft accounting for wind speed and direction relative to the three-dimensional terrain display.

The FPM is always available when the Synthetic Terrain feature is in operation. The FPM represents the direction of the flight path as it relates to the terrain and obstacles on the display, while the airplane symbol represents the aircraft heading.

The FPM works in conjunction with the Pathways feature to assist the pilot in maintaining desired altitudes and direction when navigating a flight plan. When on course and altitude the FPM is aligned inside the pathway boxes as shown (Figure 8-7).

The FPM may also be used to identify a possible conflict with the aircraft flight path and distant terrain or obstacles. Displayed terrain or obstacles in the aircraft's flight path extending above the FPM could indicate a potential conflict, even before an alert is issued by the Terrain-SVS system. However, decisions regarding terrain and/or obstacle avoidance should not be made using only the FPM.



Figure 8-7 Flight Path Marker and Pathways

## ZERO PITCH LINE

The Zero Pitch Line is drawn completely across the display and represents the aircraft attitude with respect to the horizon. It may not align with the terrain horizon, particularly when the terrain is mountainous or when the aircraft is flown at high altitudes.

## HORIZON HEADING

The Horizon Heading is synchronized with the HSI and shows approximately 60 degrees of compass heading in 30-degree increments on the Zero Pitch Line. Horizon Heading tick marks and digits appearing on the zero pitch line are not visible behind either the airspeed or altitude display. Horizon Heading is used for general heading awareness, and is activated and deactivated by pressing the **HRZN HDG** Softkey.

## TRAFFIC



**WARNING:** Intruder aircraft at or below 500 ft. AGL may not appear on the SVS display or may appear as a partial symbol.

Traffic symbols are displayed in their approximate locations as determined by the related traffic systems. Traffic symbols are displayed in three dimensions, appearing larger as they are getting closer, and smaller when they are further away. Traffic within 250 feet laterally of the aircraft will not be displayed on the SVS display. Traffic symbols and coloring are consistent with that used for traffic displayed in the Inset map or MFD traffic page. If the traffic altitude is unknown, the traffic will not be displayed on the SVS display. For more details refer to the traffic system discussion in the Hazard Avoidance section.

## AIRPORT SIGNS

Airport Signs provide a visual representation of airport location and identification on the synthetic terrain display. When activated, the signs appear on the display when the aircraft is approximately 15 nm from an airport and disappear at approximately 4.5 nm. Airport signs are shown without the identifier until the aircraft is approximately eight nautical miles from the airport. Airport signs are not shown behind the airspeed or altitude display. Airport signs are activated and deactivated by pressing the **APTSIGNS** Softkey.



Figure 8-8 Airport Signs



RUNWAYS

**WARNING:** Do not use SVS runway depiction as the sole means for determining the proximity of the aircraft to the runway or for maintaining the proper approach path angle during landing.

**NOTE:** Not all airports have runways with endpoint data in the database, therefore, these runways are not displayed.

Runway data provides improved awareness of runway location with respect to the surrounding terrain. All runway thresholds are depicted at their respective elevations as defined in the database. In some situations, where threshold elevations differ significantly, crossing runways may appear to be layered. As runways are displayed, those within 45 degrees of the aircraft heading are displayed in white. Other runways will be gray in color. When an approach for a specific runway is active, that runway will appear brighter and be outlined with a white box, regardless of the runway orientation as related to aircraft heading. As the aircraft gets closer to the runway, more detail such as runway numbers and centerlines will be displayed.



Figure 8-9 Airport Runways

### TERRAIN-SVS ALERTING

Terrain alerting on the synthetic terrain display is triggered by Forward-looking Terrain Avoidance (FLTA) alerts, and corresponds to the red and yellow X symbols on the Inset Map and MFD map displays. For more detailed information regarding Terrain-SVS, refer to the Hazard Avoidance Section.

In some instances, a terrain or obstacle alert may be issued with no conflict shading displayed on the synthetic terrain. In these cases, the conflict is outside the SVS field of view to the left or right of the aircraft.

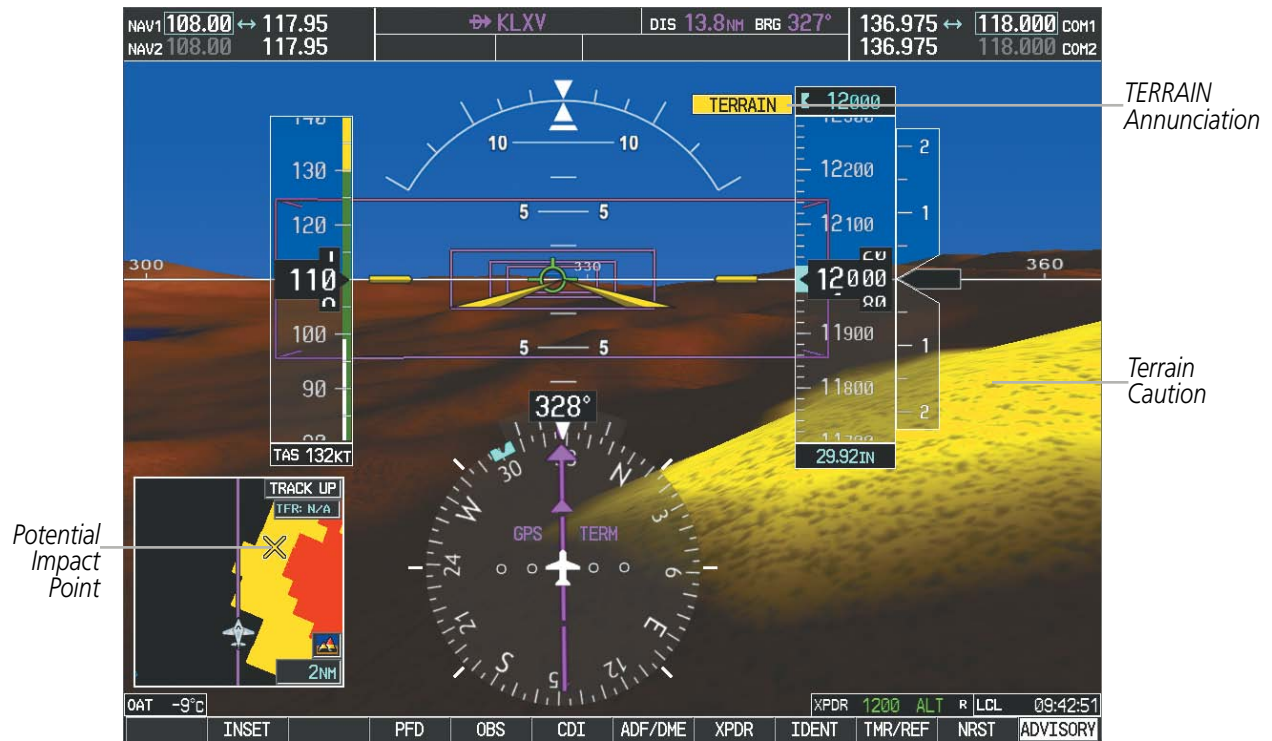

Figure 8-10 Terrain Alert

Obstacles are represented on the synthetic terrain display by standard two-dimensional tower symbols found on the Inset map and MFD maps and charts. Obstacle symbols appear in the perspective view with relative height above terrain and distance from the aircraft. Unlike the Inset map and MFD moving map display, obstacles on the synthetic terrain display do not change colors to warn of potential conflict with the aircraft's flight path until the obstacle is associated with an actual FLTA alert. Obstacles greater than 1000 feet below the aircraft altitude are not shown. Obstacles are shown behind the airspeed and altitude displays.



Figure 8-11 Obstacle

## FIELD OF VIEW

The PFD field of view can be represented on the MFD Navigation Map Page. Two dashed lines forming a V-shape in front of the aircraft symbol on the map, represent the forward viewing area shown on the PFD.

### Configuring field of view:

- 1) While viewing the Navigation Map Page, press the **MENU** Key to display the PAGE MENU.
- 2) Turn the large **FMS** Knob to highlight Map Setup and press the **ENT** Key.



Navigation Map Page OPTIONS Menu      Map Setup Menu, Map Group, Field of View Option

Figure 8-12 Option Menus

- 3) Turn the **FMS** Knob to select the Map Group and press the **ENT** Key.
- 4) Turn the large **FMS** Knob to scroll through the Map Group options to FIELD OF VIEW.
- 5) Turn the small **FMS** Knob to select On or Off.
- 6) Press the **FMS** Knob to return to the Navigation Map Page.

The following figure compares the PFD forward looking depiction with the MFD plan view and FIELD OF VIEW turned on.



SVS View on the PFD

Field of View on the MFD

Figure 8-13 PFD and MFD Field of View Comparison

## 8.2 SAFETAXI

SafeTaxi is an enhanced feature that gives greater map detail when viewing airports at close range. The maximum map ranges for enhanced detail are pilot configurable. When viewing at ranges close enough to show the airport detail, the map reveals taxiways with identifying letters/numbers, airport Hot Spots, and airport landmarks including ramps, buildings, control towers, and other prominent features. Resolution is greater at lower map ranges. When the MFD display is within the SafeTaxi ranges, the airplane symbol on the airport provides enhanced position awareness.

Designated Hot Spots are recognized at airports with many intersecting taxiways and runways, and/or complex ramp areas. Airport Hot Spots are outlined to caution pilots of areas on an airport surface where positional awareness confusion or runway incursions happen most often. Hot Spots are defined with a magenta circle or outline around the region of possible confusion.

Any map page that displays the navigation view can also show the SafeTaxi airport layout within the maximum configured range. The following is a list of pages where the SafeTaxi feature can be seen:

- Navigation Map Page
- Inset Map (PFD)
- Weather Data Link Page
- Airport Information Page
- Intersection Information Page
- NDB Information Page
- VOR Information Page
- User Waypoint Information Page
- Trip Planning Page
- Nearest Pages
- Active and Stored Flight Plan Pages

During ground operations the aircraft's position is displayed in reference to taxiways, runways, and airport features. In the example shown, the aircraft is on taxiway Bravo inside the High Alert Intersection boundary on KSFO airport. Airport Hot Spots are outlined in magenta. When panning over the airport, features such as runway holding lines and taxiways are shown at the cursor.



- SYSTEM OVERVIEW
- FLIGHT INSTRUMENTS
- EIS
- AUDIO PANEL & CNS
- FLIGHT MANAGEMENT
- HAZARD AVOIDANCE
- AFCS
- ADDITIONAL FEATURES
- APPENDICES
- INDEX



Figure 8-14 SafeTaxi Depiction on the Navigation Map Page

The **DCLTR** Softkey (declutter) label advances to DCLTR-1, DCLTR -2, and DCLTR-3 each time the softkey is pressed for easy recognition of decluttering level. Pressing the **DCLTR** Softkey removes the taxiway markings and airport feature labels. Pressing the **DCLTR-1** Softkey removes VOR and station ID, the VOR symbol, and intersection names if within the airport plan view. Pressing the **DCLTR-2** Softkey removes the airport runway layout, unless the airport in view is part of an active route structure. Pressing the **DCLTR-3** Softkey cycles back to the original map detail. Refer to Map Declutter Levels in the Flight Management Section.

**Configuring SafeTaxi range:**

- 1) While viewing the Navigation Map Page, press the **MENU** Key to display the PAGE MENU.
- 2) Turn the large **FMS** Knob to highlight the Map Setup Menu Option and press the **ENT** Key.



**Figure 8-15 Navigation Map PAGE MENU, Map Setup Option**

- 3) Turn the **FMS** Knob to select the Aviation Group and press the **ENT** Key.
- 4) Turn the large **FMS** Knob to scroll through the Aviation Group options to SAFETAXI.
- 5) Turn the small **FMS** Knob to display the range of distances.
- 6) Turn either **FMS** Knob to select the desired distance for maximum SafeTaxi display range.
- 7) Press the **ENT** Key to complete the selection.
- 8) Press the **FMS** Knob to return to the Navigation Map Page.

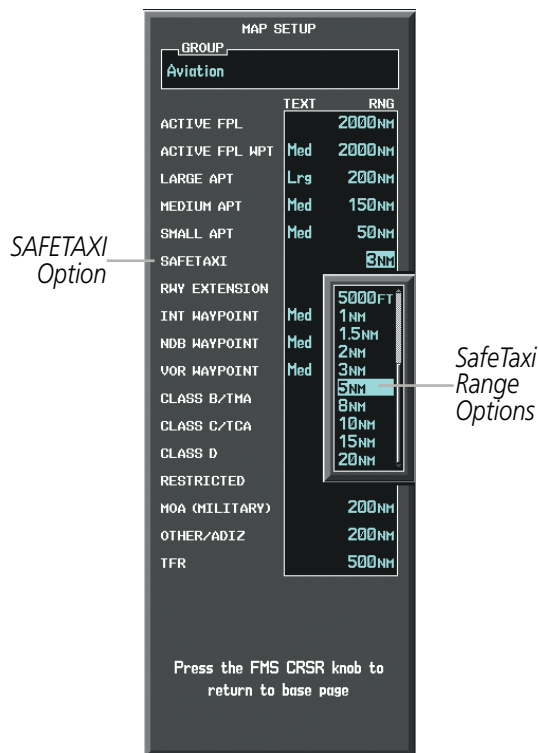

**Figure 8-16 MAP SETUP Menu, Aviation Group, SAFETAXI Range Options**



SafeTaxi database is revised every 56 days. SafeTaxi is always available for use after the expiration date. When turning on the system, the Power-up Page indicates whether the databases are current, out of date, or not available.



Figure 8-17 Power-up Page, SafeTaxi Database

Power-up Page Display	Definition
<b>A</b> → SafeTaxi Expires 10-MAR-2011	Normal operation. SafeTaxi database is valid and within current cycle.
<b>A</b> → SafeTaxi Expires 10-MAR-2011	SafeTaxi database has expired.
<b>A</b> → SafeTaxi: N/A	Database card contains no SafeTaxi data.

Table 8-1 SafeTaxi Annunciation Definitions

The SafeTaxi Region, Version, Cycle, Effective date and Expires date of the database cycle can also be found on the AUX - System Status page, as seen in Figure 8-18.

Press the **MFD1 DB** Softkey to place the cursor in the DATABASE window. Scroll through the listed information by turning the **FMS** Knob or pressing the **ENT** Key until the SafeTaxi database information is shown.

The SafeTaxi database cycle number shown in the figure, 11S1, is deciphered as follows:

- 11 – Indicates the year 2011
- S – Indicates the data is for SafeTaxi
- 1 – Indicates the first issue of the SafeTaxi database for the year

The SafeTaxi EFFECTIVE date 13-JAN-11 is the beginning date for the current database cycle. SafeTaxi EXPIRES date 10-MAR-11 is the revision date for the next database cycle.

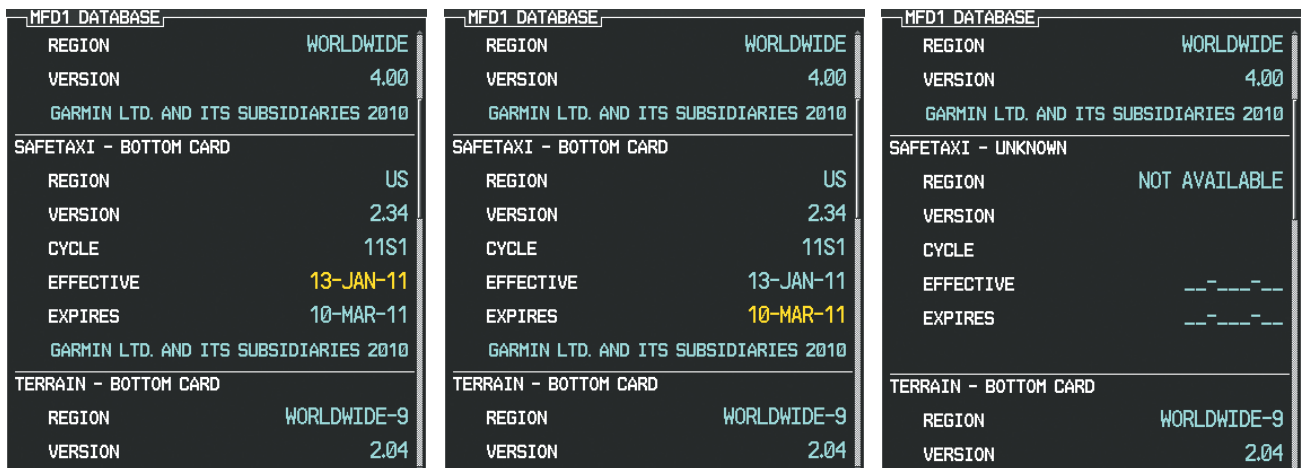

Figure 8-18 AUX – System Status Page, SafeTaxi Current Information

SafeTaxi information appears in blue and yellow text. The EFFECTIVE date appears in blue when data is current and in yellow when the current date is before the effective date. The EXPIRES date appears in blue when data is current and in yellow when expired (Figures 8-18 and 8-19). NOT AVAILABLE appears in blue in the REGION field if SafeTaxi data is not available on the database card (Figure 8-19). An expired SafeTaxi database is not disabled and will continue to function indefinitely.

Press the **MFD1 DB** Softkey a second time. The softkey label will change to **PFD1 DB**. The DATABASE window will now be displaying database information for PFD1. As before, scroll through the listed information by turning the **FMS** Knob or pressing the **ENT** Key until the SafeTaxi database information is shown.

Refer to Updating Garmin Databases in Appendix B for instructions on revising the SafeTaxi database.



Current Date is before Effective Date

SafeTaxi Database has Expired

SafeTaxi Database Not Installed

Figure 8-19 AUX – System Status Page, SafeTaxi Database Status

## 8.3 CHARTVIEW

ChartView resembles the paper version of Jeppesen terminal procedures charts. The charts are displayed in full color with high-resolution. The MFD depiction shows the aircraft position on the moving map in the plan view of approach charts and on airport diagrams. Airport Hot Spots are outlined in magenta.

The ChartView database subscription is available from Jeppesen, Inc. Available data includes:

- Arrivals (STAR)
- Departure Procedures (DP)
- Approaches
- Airport Diagrams
- NOTAMs

### CHARTVIEW SOFTKEYS

ChartView functions are displayed on three levels of softkeys. While on the Navigation Map Page, Nearest Airports Page, or Flight Plan Page, pressing the **SHW CHRT** Softkey displays the available terminal chart and advances to the chart selection level of softkeys: **CHRT OPT**, **CHRT**, **INFO-1/INFO-2**, **DP**, **STAR**, **APR**, **WX**, **NOTAM**, and **GO BACK**. The chart selection softkeys shown below appear on the Airport Information Page.

Pressing the **GO BACK** Softkey reverts to the top level softkeys and previous page.

Pressing the **CHRT OPT** Softkey advances to the next level of softkeys: **ALL**, **HEADER**, **PLAN**, **PROFILE**, **MINIMUMS**, **FIT WDTN**, **FULL SCN**, and **BACK**.

While viewing the **CHRT OPT** Softkeys, after 45 seconds of softkey inactivity, the system reverts to the chart selection softkeys.

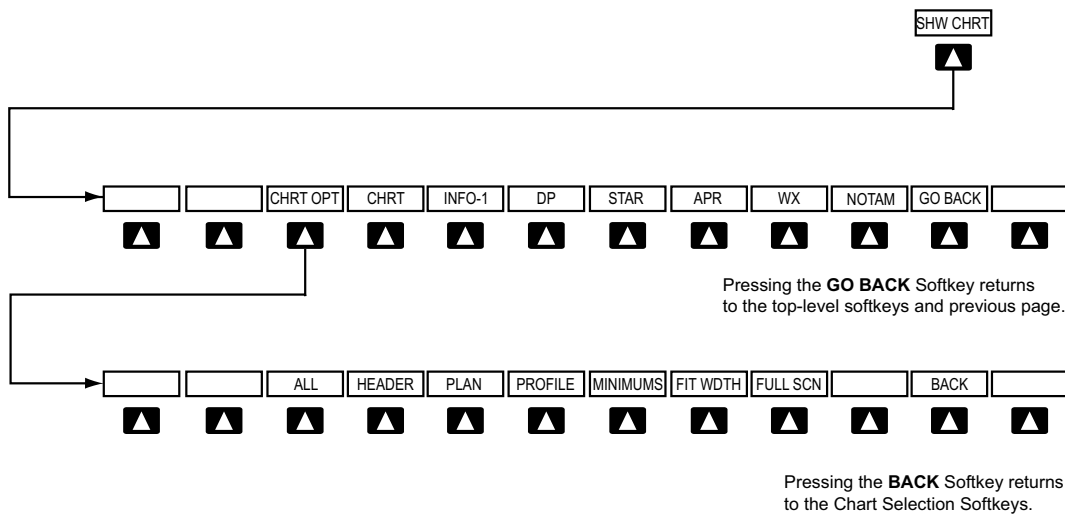

Figure 8-20 ChartView SHW CHRT, Chart Selection, and Chart Option Softkeys

## TERMINAL PROCEDURES CHARTS

### Selecting Terminal Procedures Charts:

While viewing the Navigation Map Page, Nearest Airport Page, or Flight Plan Page, press the **SHW CHRT** Softkey.

Or:

- 1) Press the **MENU** Key to display the PAGE MENU.
- 2) Turn the large **FMS** Knob to scroll through the OPTIONS Menu to Show Chart.
- 3) Press the **ENT** Key to display the chart.

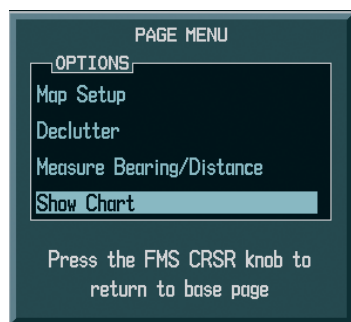

Navigation Map Page OPTIONS Menu



Waypoint Airport Information Page OPTIONS Menu

Figure 8-21 Option Menus

When no terminal procedure chart is available for the nearest airport or the selected airport, the banner **CHART NOT AVAILABLE** appears on the screen. The **CHART NOT AVAILABLE** banner does not refer to the Jeppesen subscription, but rather the availability of a particular airport chart selection or procedure for a selected airport.



Figure 8-22 Chart Not Available Banner

If there is a problem in rendering the data (such as a data error or a failure of an individual chart), the banner **UNABLE TO DISPLAY CHART** is then displayed.



Figure 8-23 Unable To Display Chart Banner

SYSTEM OVERVIEW

FLIGHT INSTRUMENTS

EIS

AUDIO PANEL & CNS

FLIGHT MANAGEMENT

HAZARD AVOIDANCE

AFCS

ADDITIONAL FEATURES

APPENDICES

INDEX

When a chart is not available by pressing the **SHW CHRT** Softkey or selecting a Page Menu Option, charts may be obtained for other airports from the WPT Pages or Flight Plan Pages.

If a chart is available for the destination airport, or the airport selected in the active flight plan, the chart appears on the screen. When no flight plan is active, or when not flying to a direct-to destination, pressing the **SHW CHRT** Softkey displays the chart for the nearest airport, if available.

The chart shown is one associated with the WPT – Airport Information page. Usually this is the airport runway diagram. Where no runway diagram exists, but Take Off Minimums or Alternate Minimums are available, that page appears. If Airport Information pages are unavailable, the Approach Chart for the airport is shown.

**Selecting a chart:**

- 1) While viewing the Navigation Map Page, Flight Plan Page, or Nearest Airports Page, press the **SHW CHRT** Softkey. The airport diagram or approach chart is displayed on the Airport Information Page.
- 2) Press the **FMS** Knob to activate the cursor.
- 3) Turn the large **FMS** Knob to select either the Airport Identifier Box or the Approach Box. (Press the **APR** Softkey if the Approach Box is not currently shown).
- 4) Turn the small and large **FMS** Knob to enter the desired airport identifier.
- 5) Press the **ENT** Key to complete the airport selection.
- 6) Turn the large **FMS** Knob to select the Approach Box.
- 7) Turn the small **FMS** Knob to show the approach chart selection choices.
- 8) Turn either **FMS** Knob to scroll through the available charts.
- 9) Press the **ENT** Key to complete the chart selection.

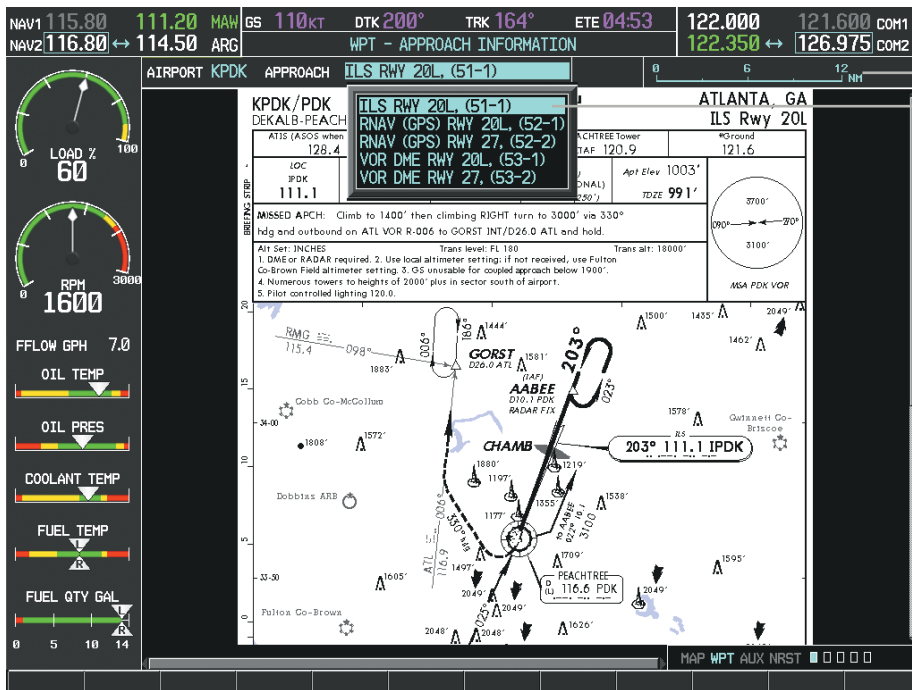

Chart Scale  
Select Desired  
Approach Chart  
From Menu

Scroll Through  
Chart With  
the Joystick

Figure 8-24 Approach Information Page, Chart Selection

While the APPROACH Box is selected using the **FMS** Knob, the G1000 softkeys are blank. Once the desired chart is selected, the chart scale can be changed and the chart page can be scrolled using the **Joystick**. Pressing the **Joystick** centers the chart on the screen.

The aircraft symbol is shown on the chart only if the chart is to scale and the aircraft position is within the boundaries of the chart. The aircraft symbol is not displayed when the Aircraft Not Shown Icon appears (Figure 8-28). If the Chart Scale Box displays a banner NOT TO SCALE, the aircraft symbol is not shown. The Aircraft Not Shown Icon may appear at certain times, even if the chart is displayed to scale.

Pressing the **CHRT** Softkey switches between the ChartView diagram and the associated map in the WPT page group. In the example shown, the **CHRT** Softkey switches between the Colorado Springs, CO (KCOS) Airport Diagram and the navigation map on the WPT – Airport Information page.

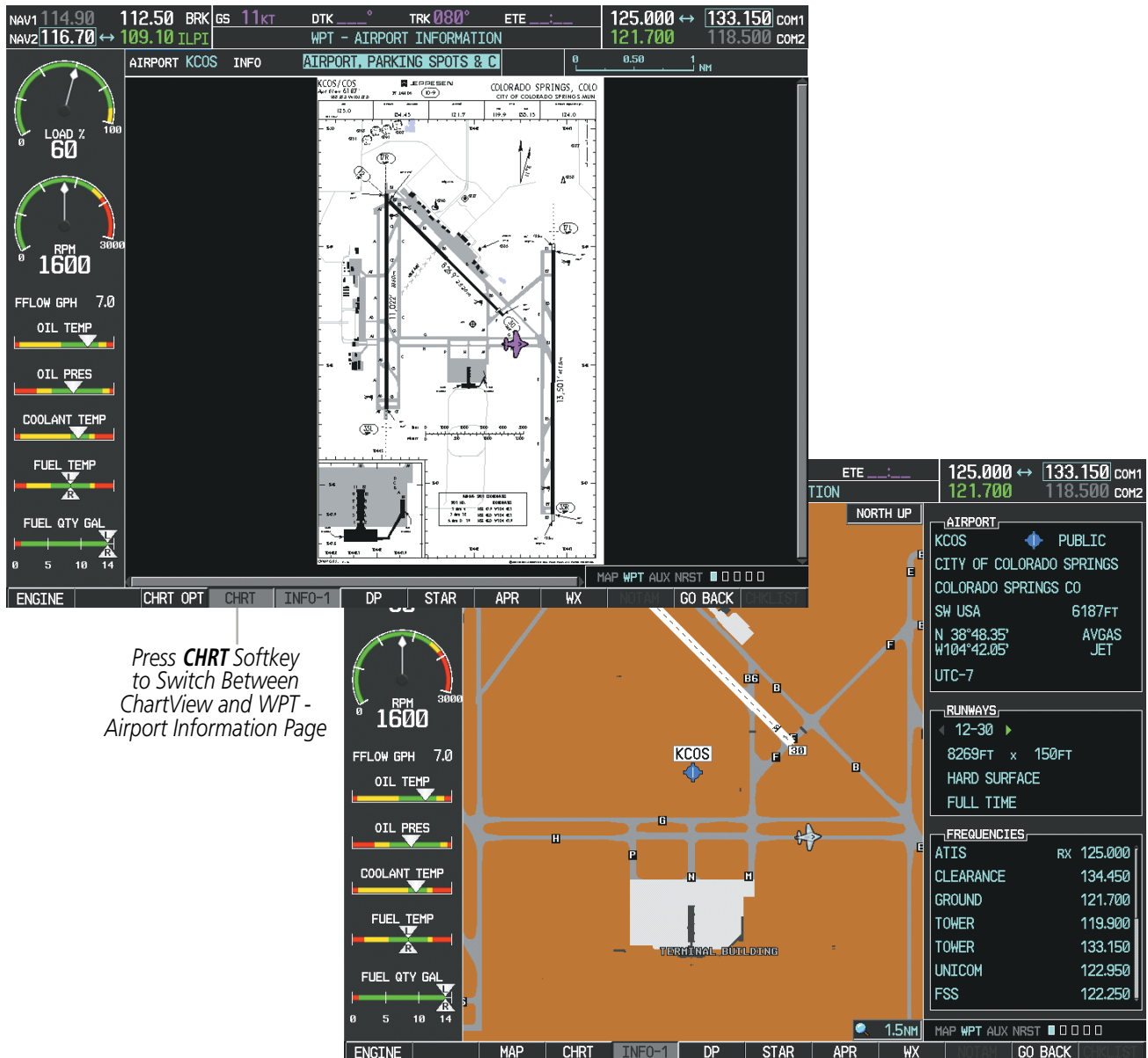

Figure 8-25 CHRT Softkey, Airport Information Page

SYSTEM OVERVIEW

FLIGHT INSTRUMENTS

EIS

AUDIO PANEL & CNS

FLIGHT MANAGEMENT

HAZARD AVOIDANCE

AFCS

ADDITIONAL FEATURES

APPENDICES

INDEX



Pressing the **INFO-1** or **INFO-2** Softkey returns to the airport diagram when the view is on a different chart. If the displayed chart is the airport diagram, the **INFO-1** or **INFO-2** Softkey has no effect.

The aircraft position is shown in magenta on the ChartView diagrams when the location of the aircraft is within the chart boundaries. In the example shown, the aircraft is turning onto Taxiway Romeo on the Charlotte, NC (KCLT) airport.

Another source for additional airport information is from the INFO Box above the chart for certain airports. This information source is not related to the **INFO-1** or **INFO-2** Softkey. When the INFO Box is selected using the **FMS** Knob, the G1000 softkeys are blank. The Charlotte, NC airport has five additional charts offering information; the Airport Diagram, Take-off Minimums, Class B Airspace, Airline Parking Gate Coordinates, and Airline Parking Gate Location. (The numbers in parentheses after the chart name are Jeppesen designators.)



Figure 8-26 Airport Information Page, INFO View, Full Screen Width



In the example shown in Figure 8-26, the Class B Chart is selected. Pressing the **ENT** Key displays the Charlotte Class B Airspace Chart (Figure 8-27).

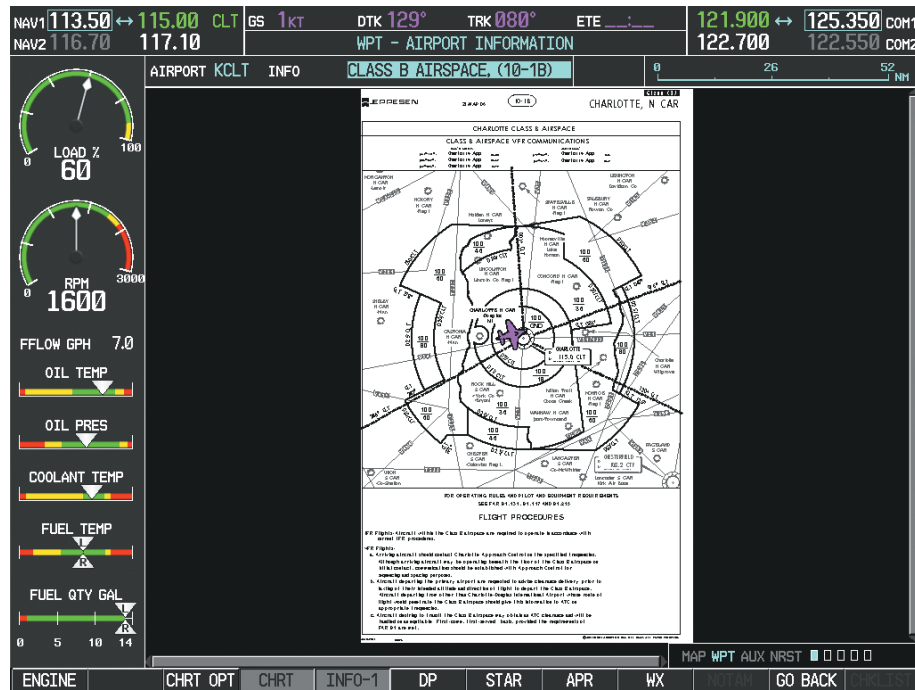

Figure 8-27 Airport Information Page, Class B Chart Selected from INFO View

Pressing the **DP** Softkey displays the Departure Procedure Chart if available.

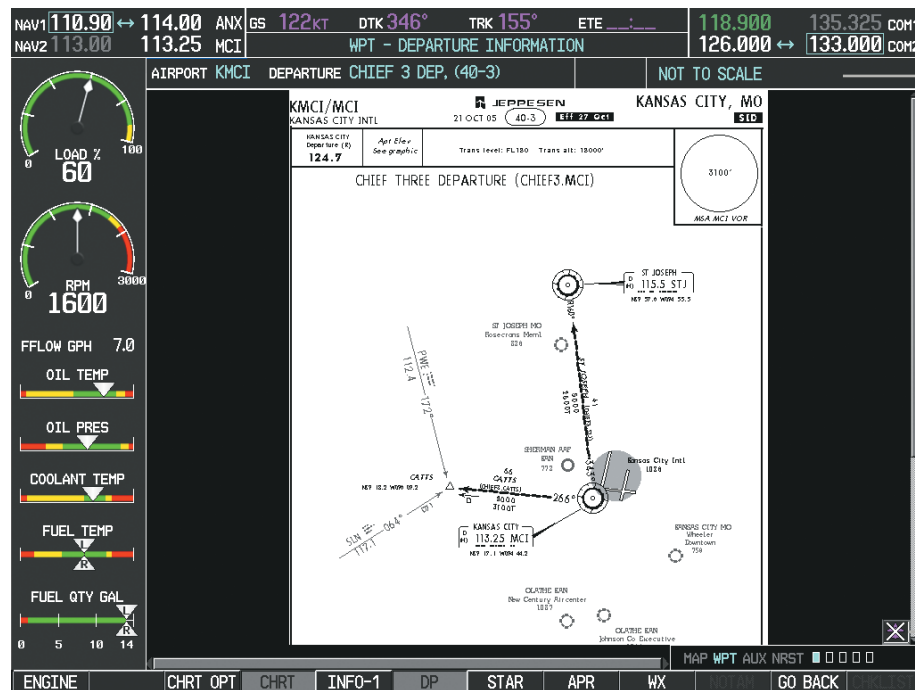

Figure 8-28 Departure Information Page

Pressing the **STAR** Softkey displays the Standard Terminal Arrival Chart if available.

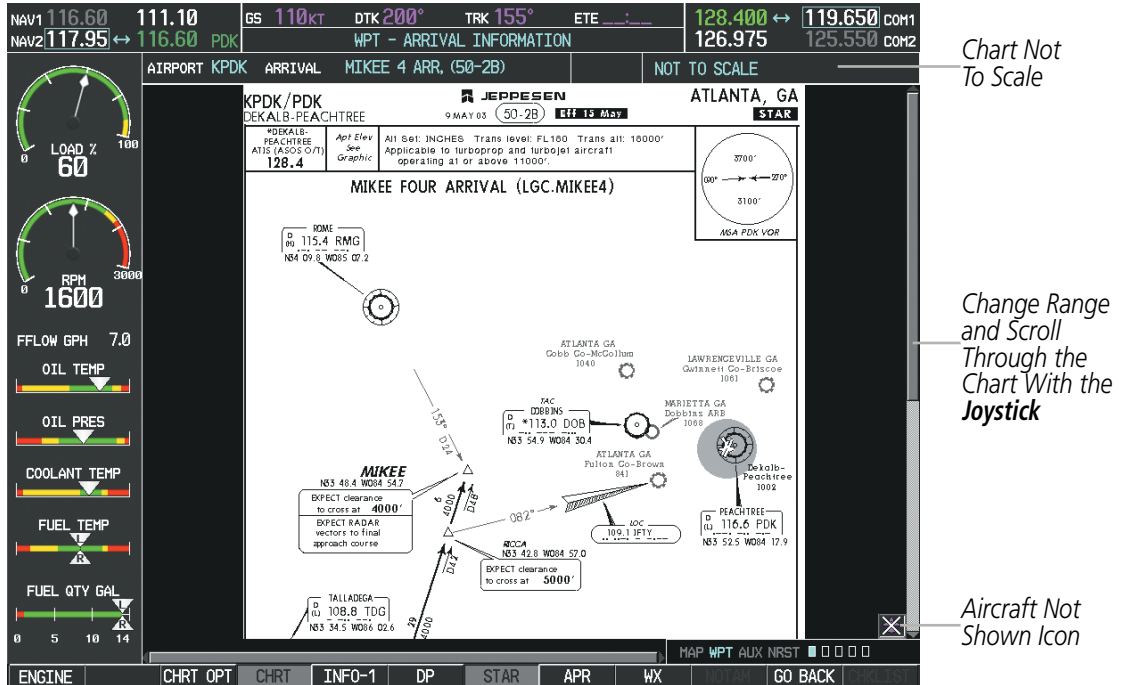

Figure 8-29 Arrival Information Page

Pressing the **APR** Softkey displays the approach chart for the airport if available.

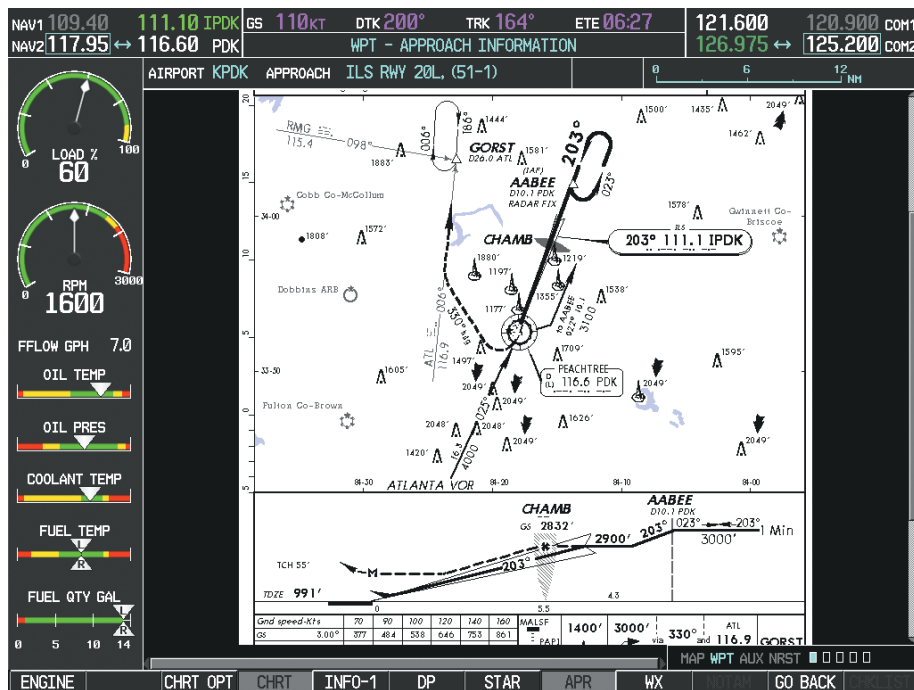

Figure 8-30 Approach Information Page

Pressing the **WX** Softkey shows the airport weather frequency information, and includes weather data such as METAR and TAF from the XM Data Link Receiver, when available. Weather information is available only when an XM Data Link Receiver is installed and the XM WX Satellite Weather subscription is current.

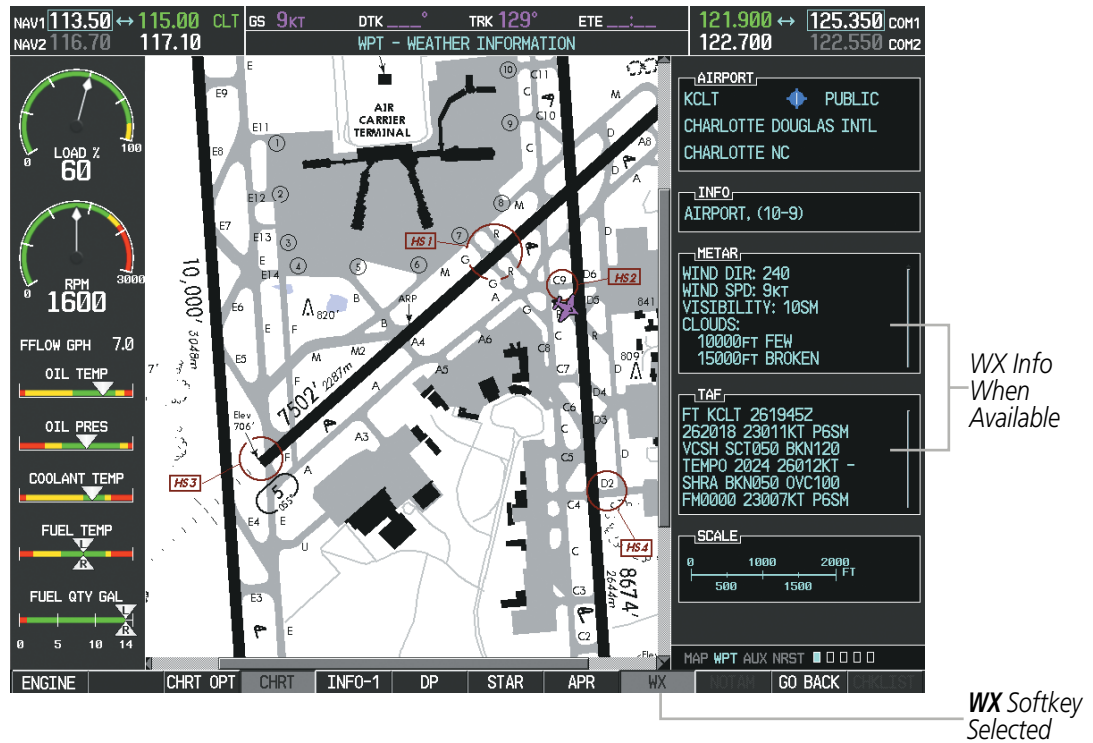
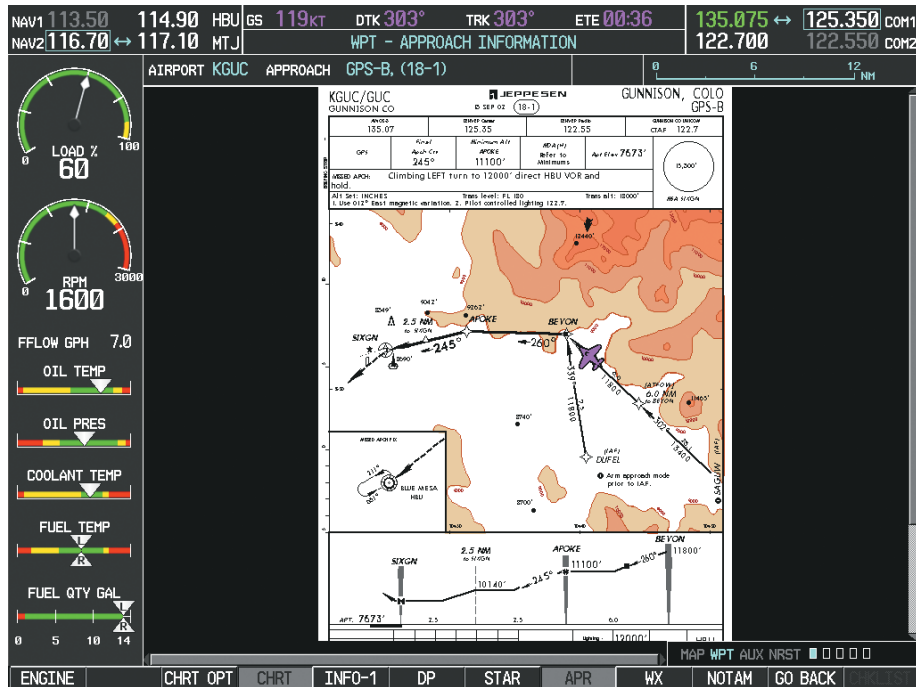

Figure 8-31 Weather Information Page

**NOTE:** A subdued softkey label indicates the function is disabled.

Recent NOTAMS applicable to the current ChartView cycle are included in the ChartView database. Pressing the **NOTAM** Softkey shows the local NOTAM information for selected airports, when available. When NOTAMS are not available, the **NOTAM** Softkey label appears subdued and is disabled as shown in Figure 8-31. The **NOTAM** Softkey may appear on the Airport Information Page and all of the chart page selections.

- SYSTEM OVERVIEW
- FLIGHT INSTRUMENTS
- EIS
- AUDIO PANEL & CNS
- FLIGHT MANAGEMENT
- HAZARD AVOIDANCE
- AFCS
- ADDITIONAL FEATURES
- APPENDICES
- INDEX



NOTAM Softkey Appears for Selected Airports

Figure 8-32 NOTAM Softkey Highlighted

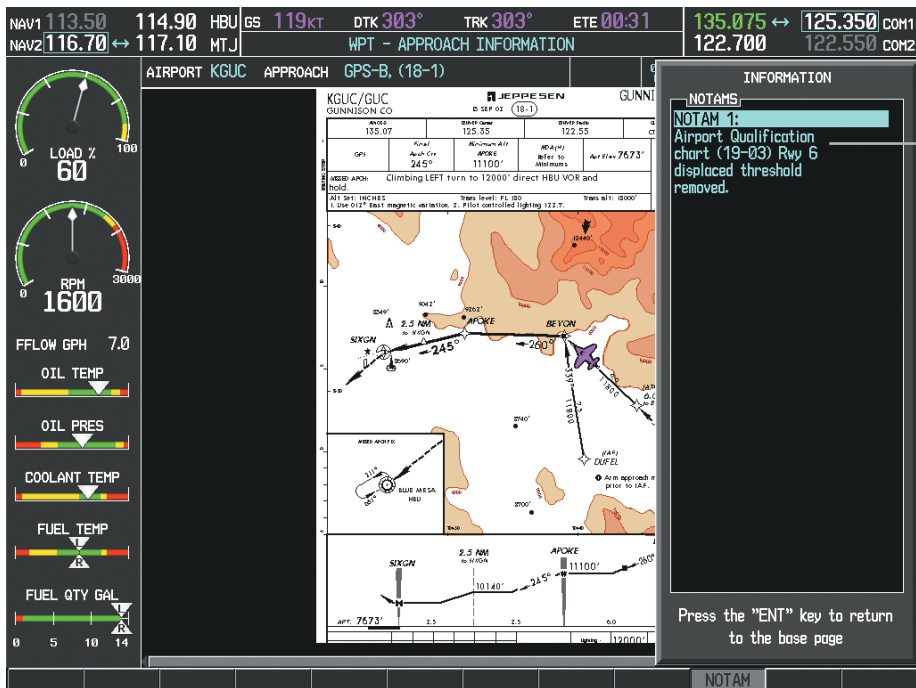

Local NOTAM on This Airport

NOTAM Softkey Selected

Figure 8-33 Airport Information Page, Local NOTAMs

Pressing the **NOTAM** Softkey again removes the NOTAMS information.

Pressing the **GO BACK** Softkey reverts to the previous page (Navigation Map Page, Nearest Pages, or Flight Plan Page).

**CHART OPTIONS**

Pressing the **CHRT OPT** Softkey displays the next level of softkeys, the chart options level (Figure 8-20).

Pressing the **ALL** Softkey shows the complete approach chart on the screen.

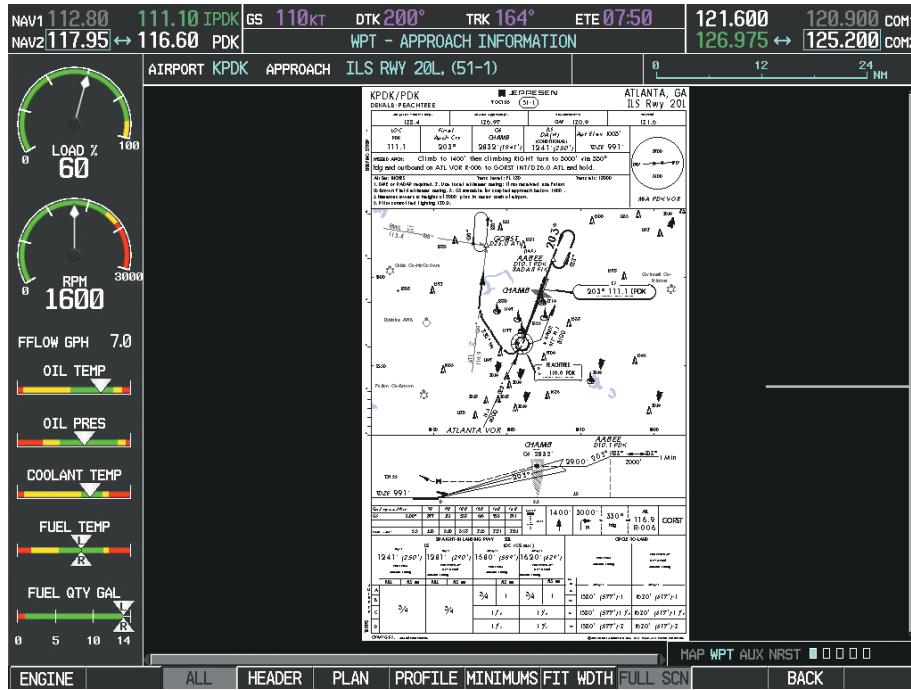

Figure 8-34 Approach Information Page, ALL View

SYSTEM OVERVIEW

FLIGHT INSTRUMENTS

EIS

AUDIO PANEL & CNS

FLIGHT MANAGEMENT

HAZARD AVOIDANCE

AFCS

ADDITIONAL FEATURES

APPENDICES

INDEX

Pressing the **HEADER** Softkey shows the header view (approach chart briefing strip) on the screen.

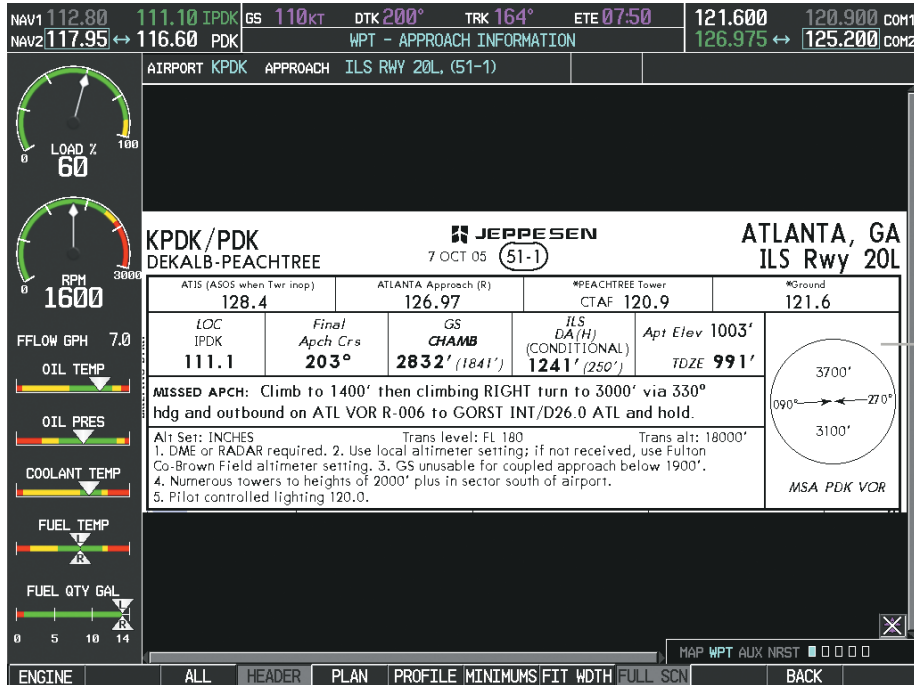

Approach Chart Briefing Strip

Figure 8-35 Approach Information Page, Header View

Pressing the **PLAN** Softkey shows the approach chart two dimensional plan view.

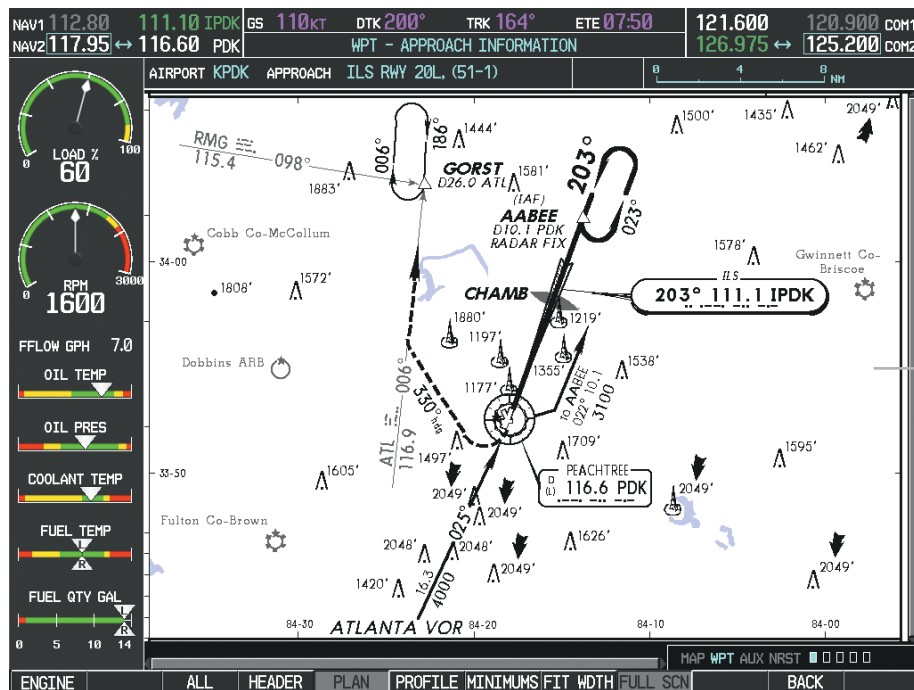

Approach Chart Plan View

Figure 8-36 Approach Information Page, Plan View



Pressing the **PROFILE** Softkey displays the approach chart descent profile strip.

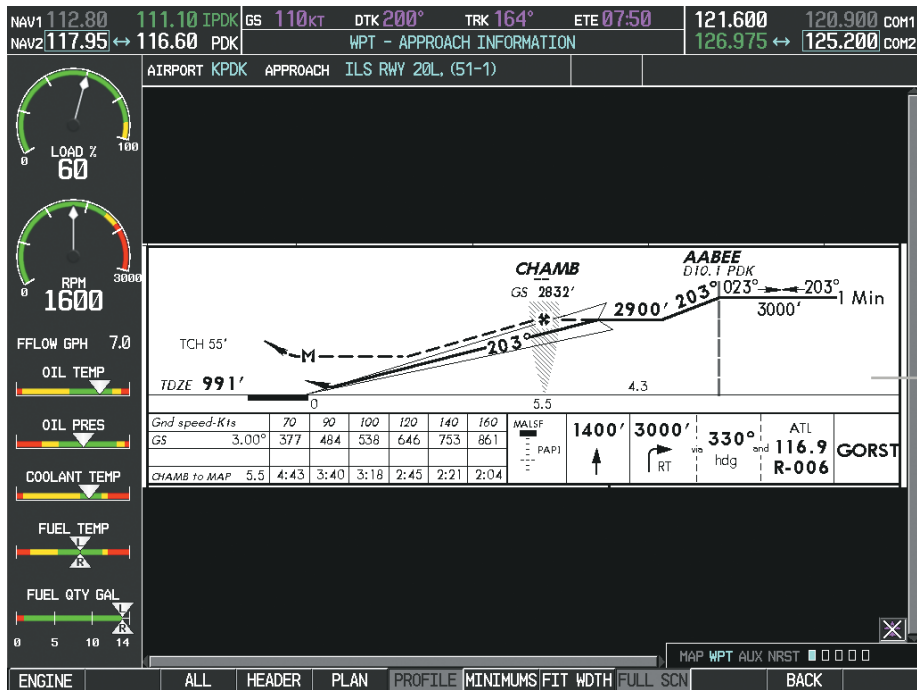

Figure 8-37 Approach Information Page, Profile View, Full Screen Width

Pressing the **MINIMUMS** Softkey displays the minimum descent altitude/visibility strip at the bottom of the approach chart.

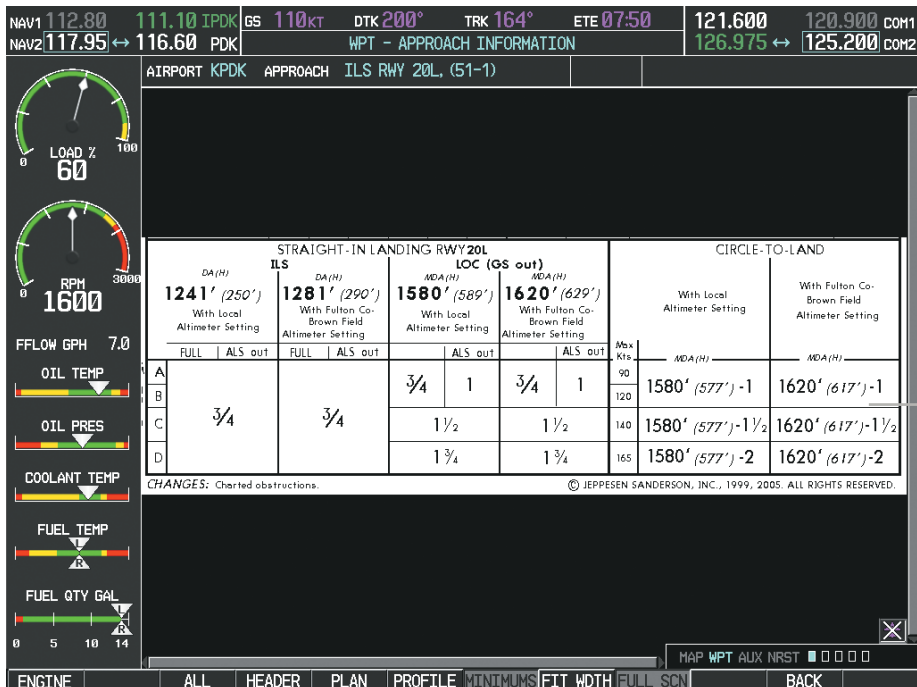

Figure 8-38 Approach Information Page, Minimums View, Full Screen Width



If the chart scale has been adjusted to view a small area of the chart, pressing the **FIT WIDTH** Softkey changes the chart size to fit the available screen width.



Press **FIT WIDTH** Softkey to Show Full Chart Width

Figure 8-39 Airport Information Page, FIT WIDTH Softkey Pressed

Pressing the **FULL SCN** Softkey alternates between removing and replacing the data window to the right.

**Selecting Additional Information:**

- 1) While viewing the Airport Taxi Diagram, press the **FULL SCN** Softkey to display the information windows (AIRPORT, INFO).
- 2) Press the **FMS** Knob to activate the cursor.
- 3) Turn the large **FMS** Knob to highlight the AIRPORT, INFO, RUNWAYS, or FREQUENCIES Box (INFO Box shown).
- 4) Turn the small **FMS** Knob to select the INFO Box choices. If multiple choices are available, scroll to the desired choice with the large **FMS** Knob and press the **ENT** Key to complete the selection.
- 5) Press the **FMS** Knob again to deactivate the cursor.

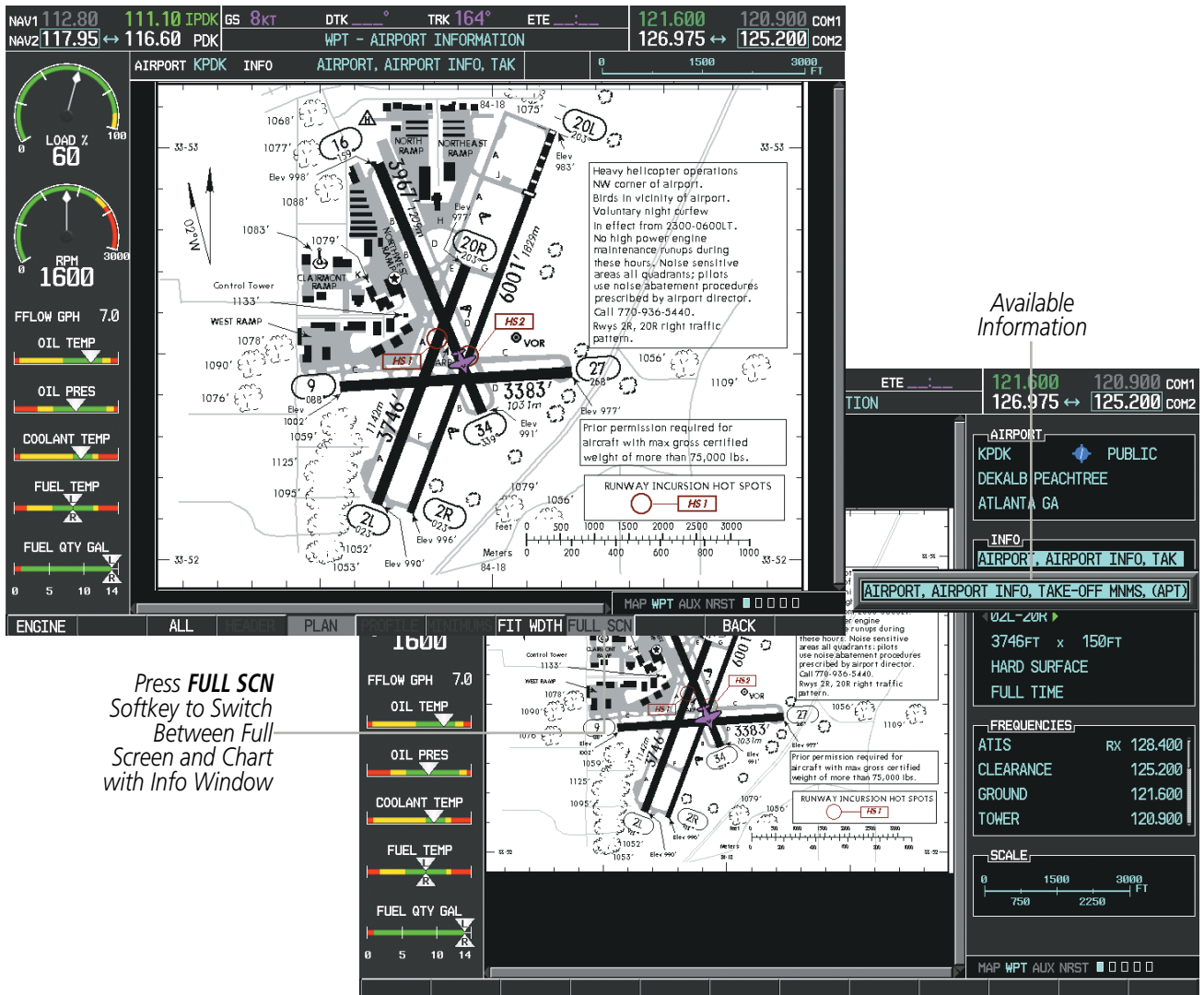

Figure 8-40 Airport Information Page, Full Screen and Info Window

Pressing the **BACK** Softkey, or waiting for 45 seconds reverts to the chart selection softkeys.

The full screen view can also be selected by using the page menu option.

**Selecting full screen On or Off:**

- 1) While viewing a terminal chart press the **MENU** Key to display the Page Menu OPTIONS.
- 2) Turn the large **FMS** Knob to highlight the Chart Setup Menu Option and press the **ENT** Key.
- 3) Turn the large **FMS** Knob to move between the FULL SCREEN and COLOR SCHEME Options.
- 4) Turn the small **FMS** Knob to choose between the On and Off Full Screen Options.

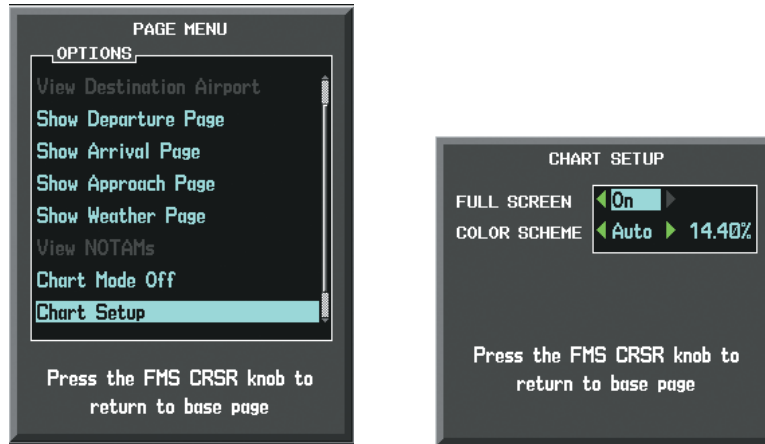

*Chart Setup Option*

*Full Screen On/Off Selection*

**Figure 8-41 Page Menus**

## DAY/NIGHT VIEW

ChartView can be displayed on a white or black background for day or night viewing. The Day View offers a better presentation in a bright environment. The Night View gives a better presentation for viewing in a dark environment. When the CHART SETUP Box is selected the G1000 softkeys are blank.

### Selecting Day, Night, or Automatic View:

- 1) While viewing a terminal chart press the **MENU** Key to display the Page Menu OPTIONS.
- 2) Turn the large **FMS** Knob to highlight the Chart Setup Menu Option and press the **ENT** Key.

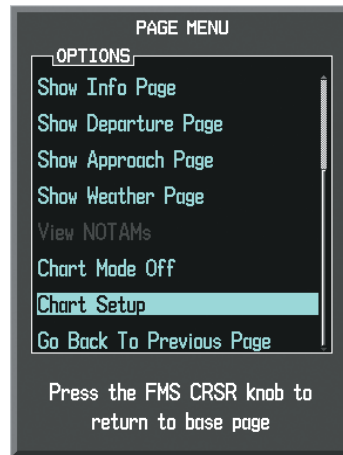

Figure 8-42 Waypoint Information Page, OPTIONS Menu

- 3) Turn the large **FMS** Knob to move to the COLOR SCHEME Option (Figure 8-43).
- 4) Turn the small **FMS** Knob to choose between Day, Auto, and Night Options.
- 5) If Auto Mode is selected, turn the large **FMS** Knob to select the percentage field. Use the small **FMS** Knob to change the percentage value. The percentage value is the day/night crossover point based on the percentage of backlighting intensity. For example, if the value is set to 15%, the day/night display changes when the display backlight reaches 15% of full brightness.

The display must be changed in order for the new setting to become active. This may be accomplished by selecting another page or changing the display range.

- 6) Press the **FMS** Knob when finished to remove the Chart Setup Menu.

- SYSTEM OVERVIEW
- FLIGHT INSTRUMENTS
- EIS
- AUDIO PANEL & CNS
- FLIGHT MANAGEMENT
- HAZARD AVOIDANCE
- AFCS
- ADDITIONAL FEATURES
- APPENDICES
- INDEX

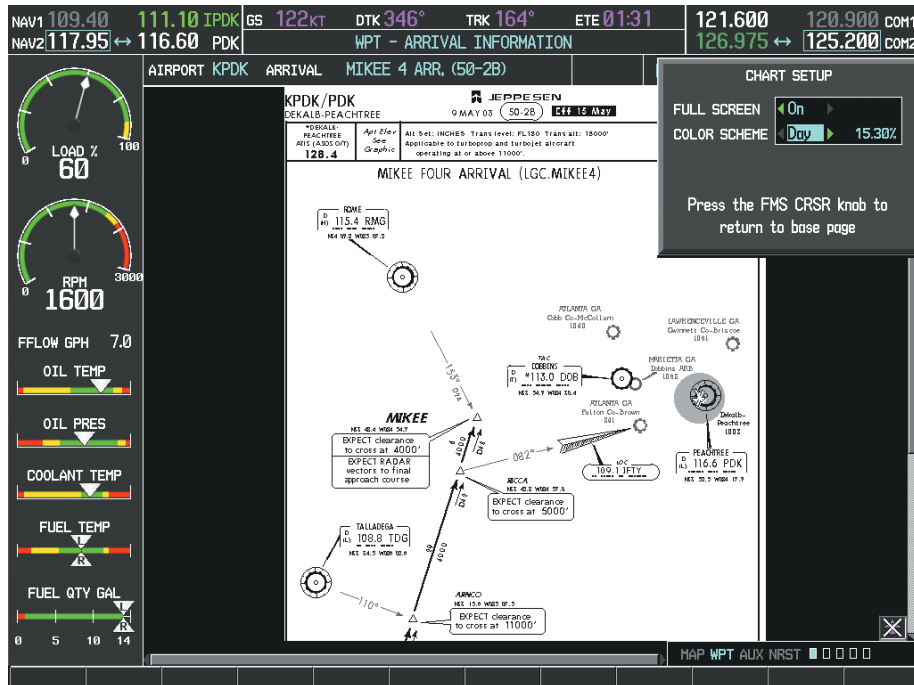

Figure 8-43 Arrival Information Page, Day View

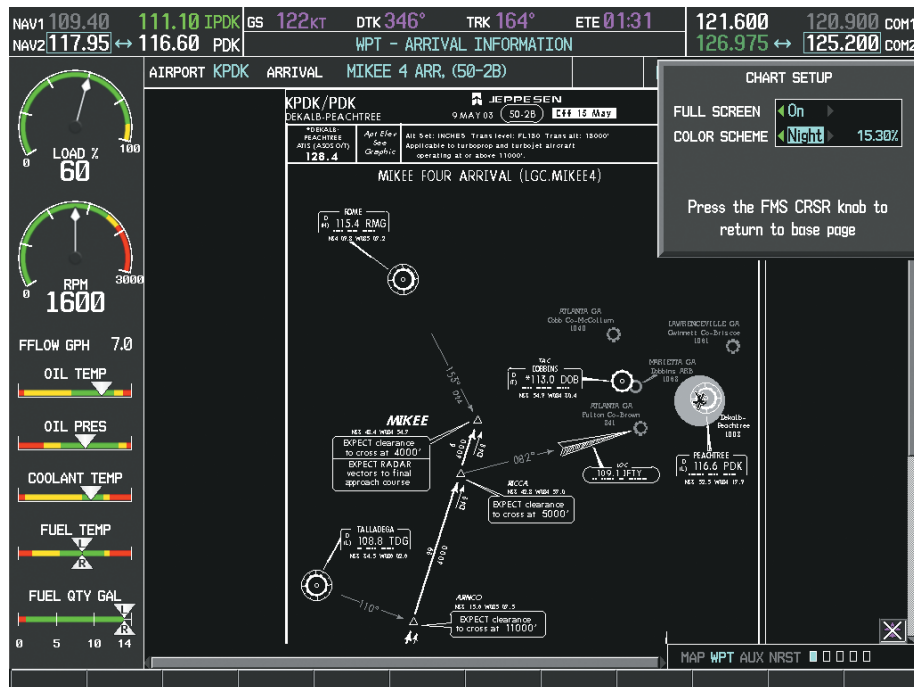

Figure 8-44 Arrival Information Page, Night View

**CHARTVIEW CYCLE NUMBER AND EXPIRATION DATE**

ChartView database is revised every 14 days. Charts are still viewable during a period that extends from the cycle expiration date to the disables date. ChartView is disabled 70 days after the expiration date and is no longer available for viewing. When turning on the system, the Power-up Page displays the current status of the ChartView database. See the table below for the various ChartView Power-up Page displays and the definition of each.

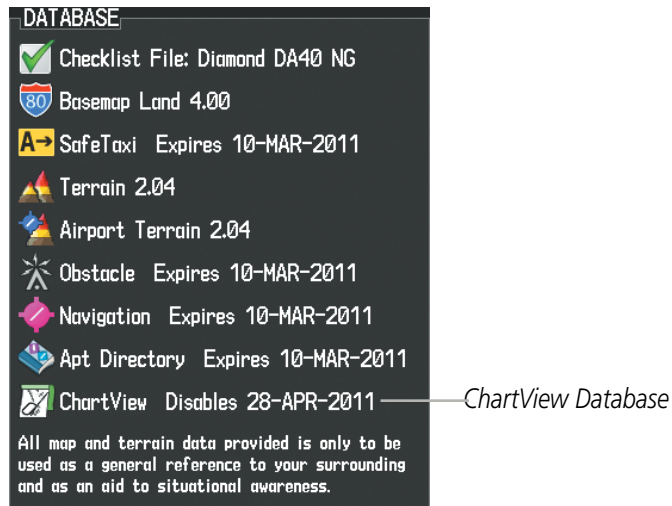

Figure 8-45 Power-up Page, ChartView Database

Power-up Page Display	Definition
	Blank Line. system is not configured for ChartView. Contact a Garmin-authorized service center for configuration.
	System is configured for ChartView but no chart database is installed. Contact Jeppesen for a ChartView database.
	Normal operation. ChartView database is valid and within current cycle.
	ChartView database is within 1 week after expiration date. A new cycle is available for update.
	ChartView database is beyond 1 week after expiration date, but still within the 70 day viewing period.
	ChartView database has timed out. Database is beyond 70 days after expiration date. ChartView database is no longer available for viewing.
	System time is not available. GPS satellite data is unknown or the system has not yet locked onto satellites. Check database cycle number for effectivity.
	System is verifying chart database when new cycle is installed for the first time.
	After verifying, chart database is found to be corrupt. ChartView is not available.

Table 8-2 ChartView Power-up Page Annunciations and Definitions



The ChartView time critical information can also be found on the AUX - System Status page. The database CYCLE number, EXPIRES, and DISABLES dates of the ChartView subscription appear in either blue or yellow text. When the ChartView EXPIRES date is reached, ChartView becomes inoperative 70 days later. This is shown as the DISABLES date. When the DISABLES date is reached, charts are no longer available for viewing. The **SHW CHRT** Softkey label then appears subdued and is disabled until a revised issue of ChartView is installed.

**NOTE:** A subdued softkey label indicates the function is disabled.

Press the **MFD1 DB** Softkey to place the cursor in the DATABASE window. Scroll through the listed information by turning the **FMS** Knob or pressing the **ENT** Key until the ChartView database information is shown.

The ChartView database cycle number shown in the figure, 1103, is deciphered as follows:

11 – Indicates the year 2011

03 – Indicates the third issue of the ChartView database for the year

The EXPIRES date 17-FEB-11 is the date that this database should be replaced with the next issue.

The DISABLES date 28-APR-11 is the date that this database becomes inoperative.

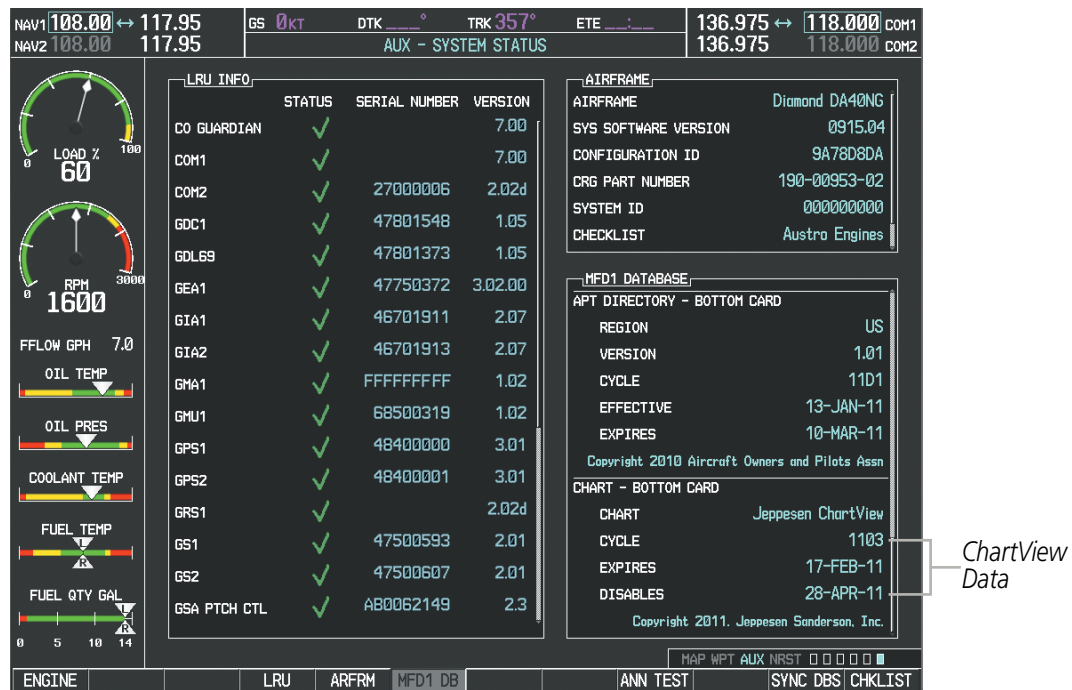

Figure 8-46 AUX – System Status Page, ChartView Current and Available

The ChartView database is provided directly from Jeppesen. Refer to Updating Jeppesen Databases in Appendix B for instructions on revising the ChartView database.



Other possible AUX - System Status page conditions are shown in Figure 8-47. The EXPIRES date, in yellow, is the revision date for the next database cycle. The DISABLES date, in yellow, is the date that this database cycle is no longer viewable. NOT AVAILABLE in blue, indicates no ChartView data is available on the database card or no database card is inserted.

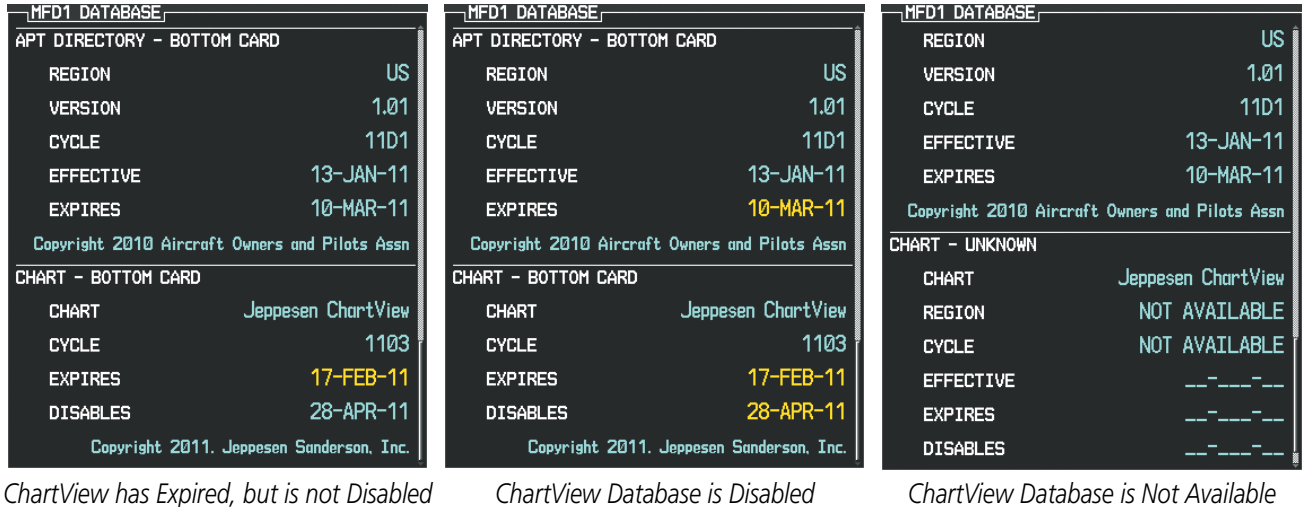

Figure 8-47 AUX – System Status Page, ChartView Database Status

- SYSTEM OVERVIEW
- FLIGHT INSTRUMENTS
- EIS
- AUDIO PANEL & CNS
- FLIGHT MANAGEMENT
- HAZARD AVOIDANCE
- AFCS
- ADDITIONAL FEATURES
- APPENDICES
- INDEX

## 8.4 FLITECHARTS

FliteCharts resemble the paper version of AeroNav Services terminal procedures charts. The charts are displayed with high-resolution and in color for applicable charts. FliteCharts database subscription is available from Garmin. Available data includes:

- Arrivals (STAR)
- Approaches
- Departure Procedures (DP)
- Airport Diagrams

### FLITECHARTS SOFTKEYS

FliteCharts functions are displayed on three levels of softkeys. While on the Navigation Map Page, Nearest Airports Page, or Flight Plan Page, pressing the **SHW CHRT** Softkey displays the available terminal chart and advances to the chart selection level of softkeys: **CHRT OPT**, **CHRT**, **INFO-1/INFO-2**, **DP**, **STAR**, **APR**, **WX**, and **GO BACK**. The chart selection softkeys appear on the Airport Information Page.

Pressing the **GO BACK** Softkey reverts to the top level softkeys and previous page.

Pressing the **CHRT OPT** Softkey displays the available terminal chart and advances to the next level of softkeys: **ALL**, **FIT WDTH**, **FULL SCN**, and **BACK**.

While viewing the **CHRT OPT** Softkeys, after 45 seconds of softkey inactivity, the system reverts to the chart selection softkeys.

NOTAMs are not available with FliteCharts. The NOTAM Softkey label appears subdued and is disabled.

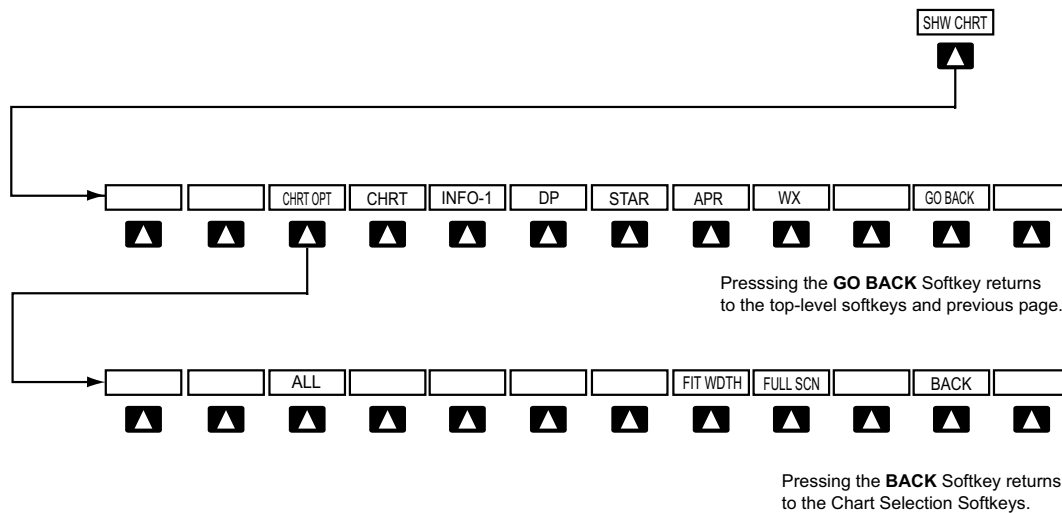

Figure 8-48 FliteCharts SHW CHRT, Chart Selection, and Chart Option Softkeys

## TERMINAL PROCEDURES CHARTS

### Selecting Terminal Procedures Charts:

While viewing the Navigation Map Page, Nearest Airport Page, or Flight Plan Page, press the **SHW CHRT** Softkey.

Or:

- 1) Press the **MENU** Key to display the PAGE MENU.
- 2) Turn the large **FMS** Knob to scroll through the OPTIONS Menu to Show Chart.
- 3) Press the **ENT** Key to display the chart.

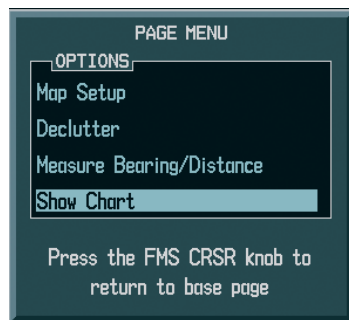

Navigation Map Page OPTIONS Menu



Waypoint Airport Information Page OPTIONS Menu

Figure 8-49 Option Menus

When no terminal procedure chart is available, the banner **CHART NOT AVAILABLE** appears on the screen. The **CHART NOT AVAILABLE** banner does not refer to the FliteCharts subscription, but rather the availability of a particular airport chart selection or procedure for a selected airport.



Figure 8-50 Chart Not Available Banner

If there is a problem in rendering the data (such as a data error or a failure of an individual chart), the banner **UNABLE TO DISPLAY CHART** is then displayed.



Figure 8-51 Unable To Display Chart Banner

SYSTEM OVERVIEW

FLIGHT INSTRUMENTS

EIS

AUDIO PANEL & CNS

FLIGHT MANAGEMENT

HAZARD AVOIDANCE

AFCS

ADDITIONAL FEATURES

APPENDICES

INDEX

When a chart is not available by pressing the **SHW CHRT** Softkey or selecting a Page Menu Option, charts may be obtained for other airports from the WPT Pages or Flight Plan Pages.

If a chart is available for the destination airport, or the airport selected in the active flight plan, the chart appears on the screen. When no flight plan is active, or when not flying to a direct-to destination, pressing the **SHW CHRT** Softkey displays the chart for the nearest airport, if available.

The chart shown is one associated with the WPT – Airport Information page. Usually this is the airport runway diagram. Where no runway diagram exists, but Take Off Minimums or Alternate Minimums are available, that page appears. If Airport Information pages are unavailable, the Approach Chart for the airport is shown.

**Selecting a chart:**

- 1) While viewing the Navigation Map Page, Flight Plan Page, or Nearest Airports Page, press the **SHW CHRT** Softkey. The airport diagram or approach chart is displayed on the Airport Information Page.
- 2) Press the **FMS** Knob to activate the cursor.
- 3) Turn the large **FMS** Knob to select either the Airport Identifier Box or the Approach Box. (Press the **APR** Softkey if the Approach Box is not currently shown).
- 4) Turn the small and large **FMS** Knob to enter the desired airport identifier.
- 5) Press the **ENT** Key to complete the airport selection.
- 6) Turn the large **FMS** Knob to select the Approach Box.
- 7) Turn the small **FMS** Knob to show the approach chart selection choices.
- 8) Turn either **FMS** Knob to scroll through the available charts.
- 9) Press the **ENT** Key to complete the chart selection.

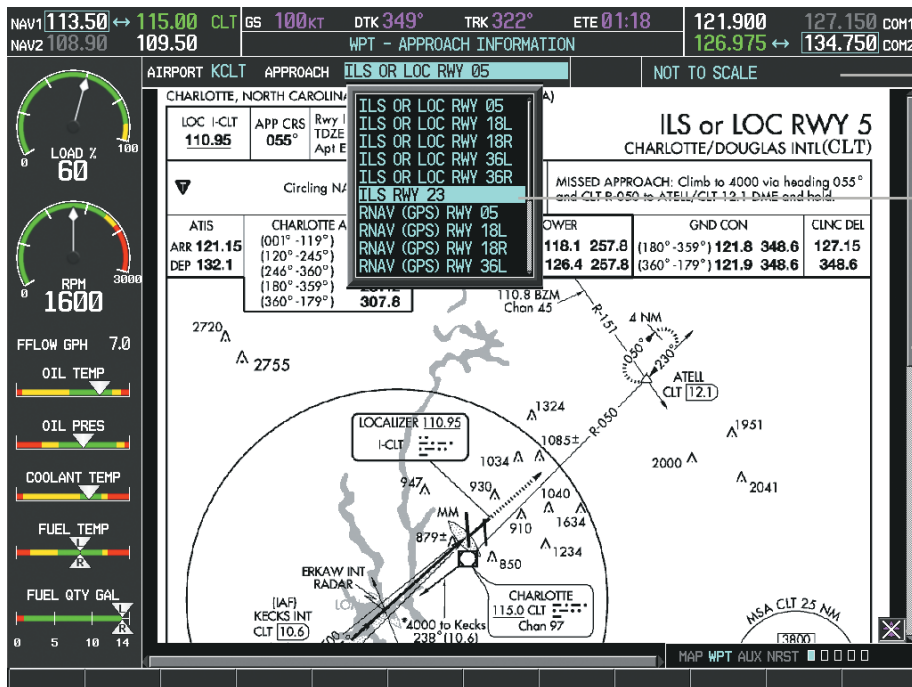

Figure 8-52 Approach Information Page, Chart Selection

While the APPROACH Box is selected using the **FMS** Knob, the G1000 softkeys are blank. Once the desired chart is selected, the chart scale can be changed and the chart can be panned using the **Joystick**. Pressing the **Joystick** centers the chart on the screen.

The aircraft symbol is not shown on FliteCharts. The Chart Scale Box displays a banner NOT TO SCALE, and the Aircraft Not Shown Icon is displayed in the lower right corner of the screen.

Pressing the **CHRT** Softkey alternates between the FliteCharts diagram and the associated map in the WPT page group. In the example shown, the **CHRT** Softkey switches between the Charlotte, NC (KCLT) Airport Diagram and the navigation map on the WPT – Airport Information page.

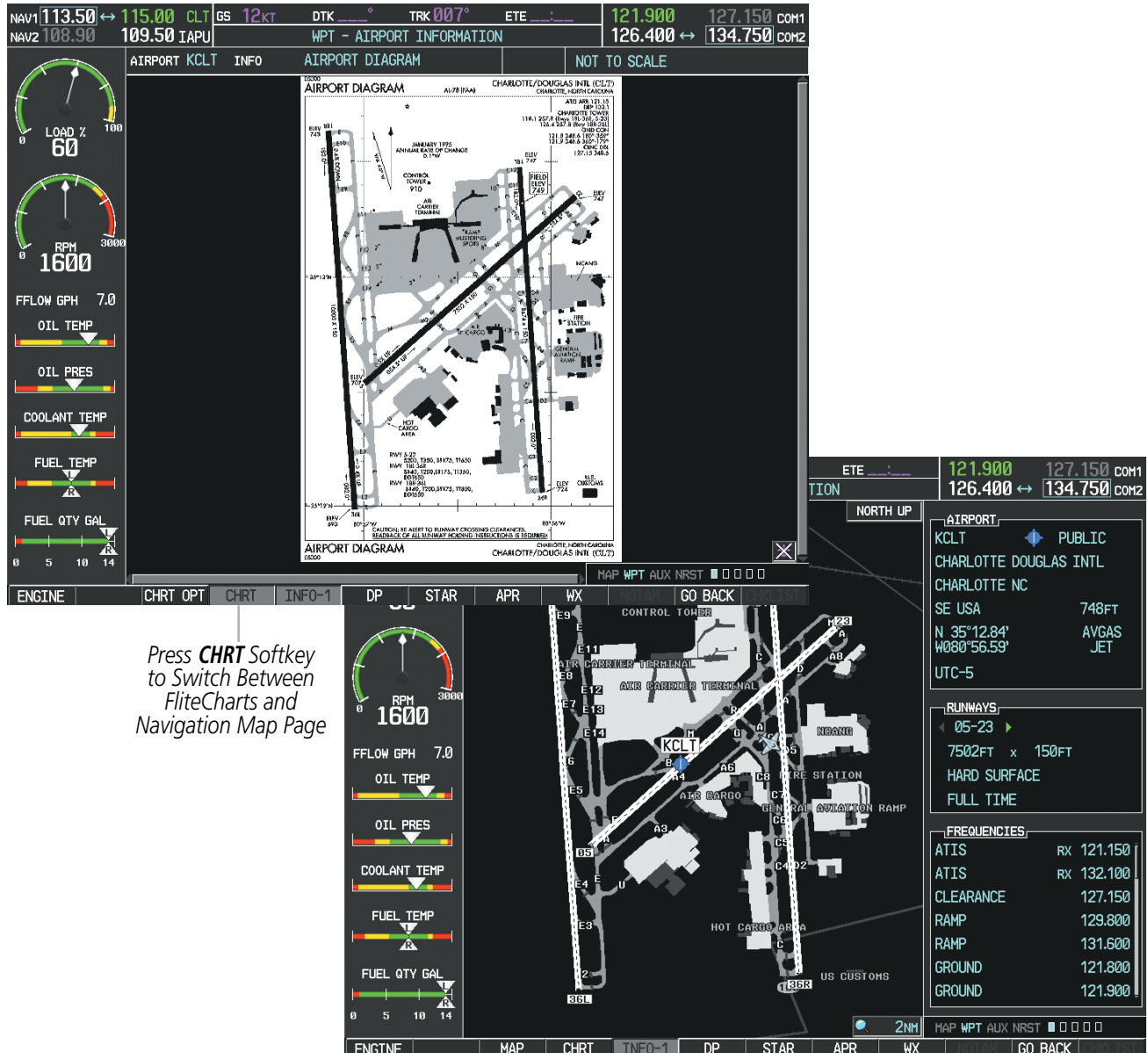

Figure 8-53 CHRT Softkey, Airport Information Page

SYSTEM OVERVIEW

FLIGHT INSTRUMENTS

EIS

AUDIO PANEL & CNS

FLIGHT MANAGEMENT

HAZARD AVOIDANCE

AFCS

ADDITIONAL FEATURES

APPENDICES

INDEX

Pressing the **INFO-1** or **INFO-2** Softkey returns to the airport diagram when the view is on a different chart. If the displayed chart is the airport diagram, the **INFO-1** or **INFO-2** Softkey has no effect.

Another source for additional airport information is from the INFO Box above the chart (Figure 8-53) or to the right of the chart (Figure 8-54) for certain airports. This information source is not related to the **INFO-1** or **INFO-2** Softkey. When the INFO Box is selected using the **FMS** Knob, the G1000 softkeys are blank. The Charlotte, NC airport has three additional charts offering information; the Airport Diagram, Alternate Minimums, and Take-off Minimums.

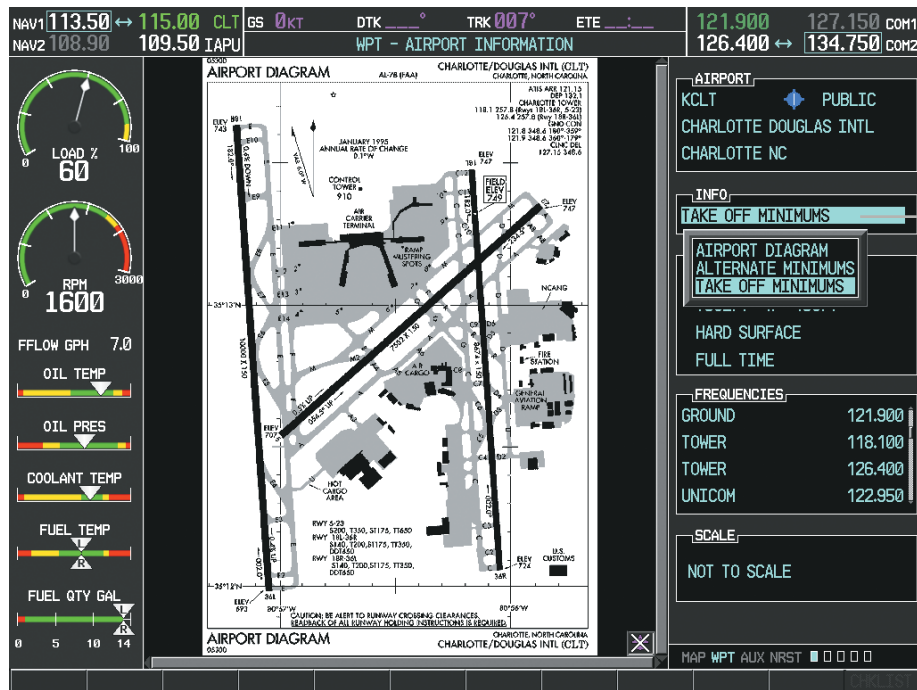

Figure 8-54 Airport Information Page, INFO View with Airport Information



In the example shown in Figure 8-54, TAKE OFF MINIMUMS is selected. Pressing the ENT Key displays the Take-off Minimums and Departure Procedures Chart (Figure 8-55).

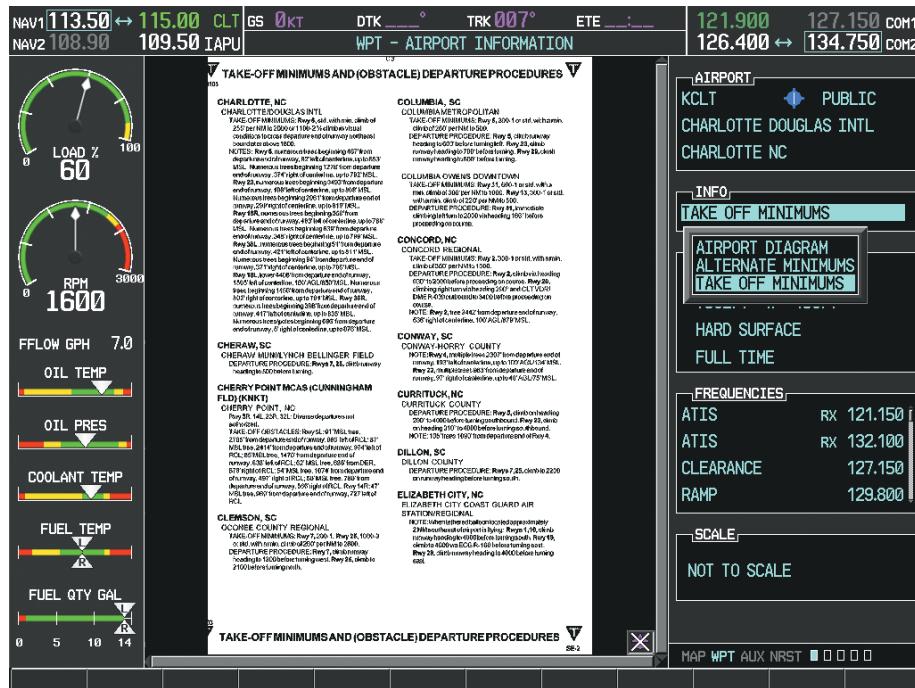

Figure 8-55 Airport Information Page, TAKE OFF MINIMUMS Selected from INFO View

Pressing the DP Softkey displays the Departure Procedure Chart if available.

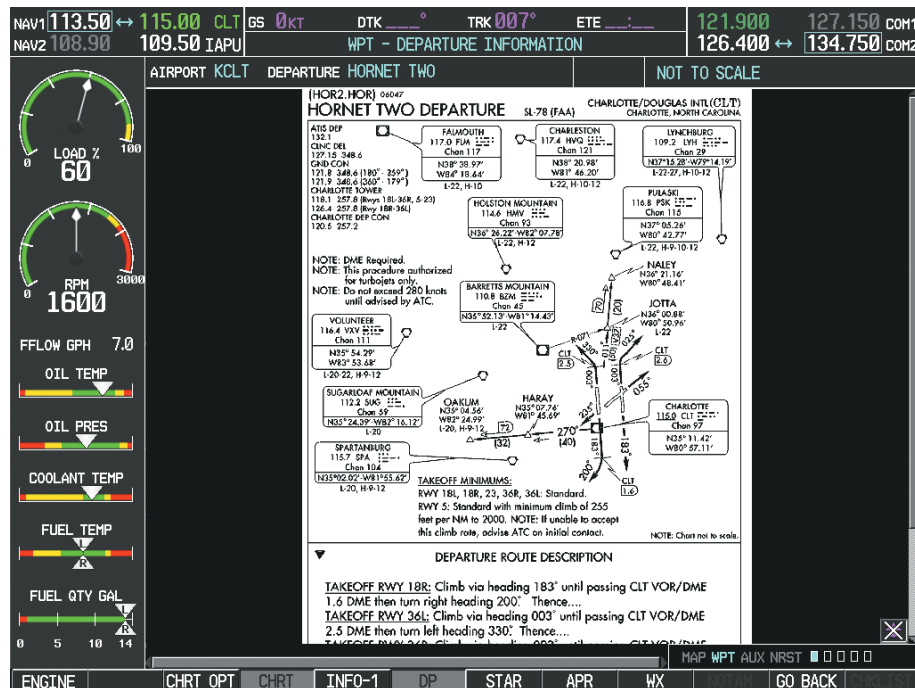

Figure 8-56 Departure Information Page



Pressing the **STAR** Softkey displays the Standard Terminal Arrival Chart if available.

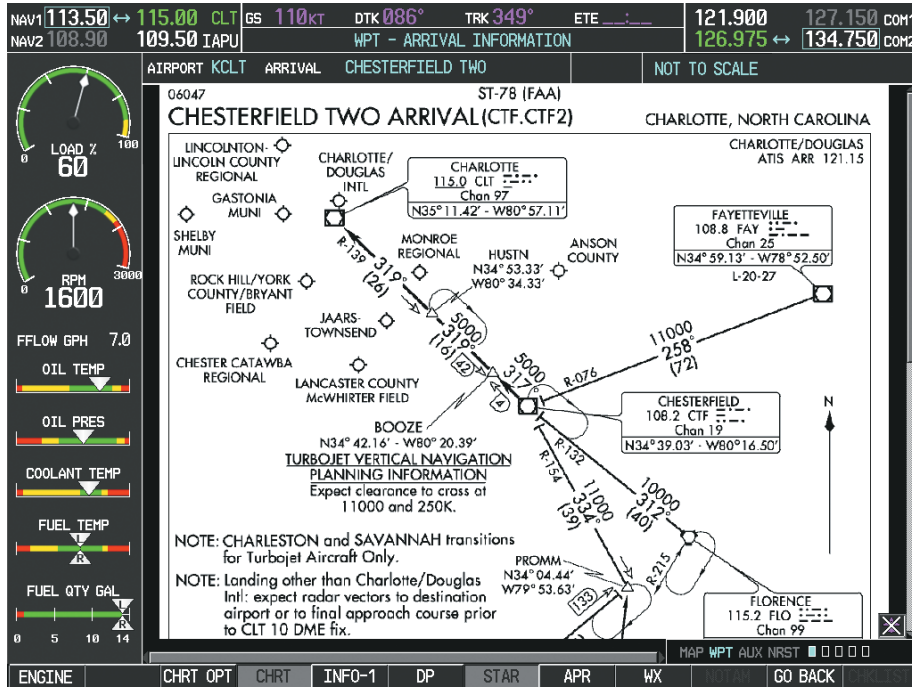

Figure 8-57 Arrival Information Page

Pressing the **APR** Softkey displays the approach chart for the airport if available.

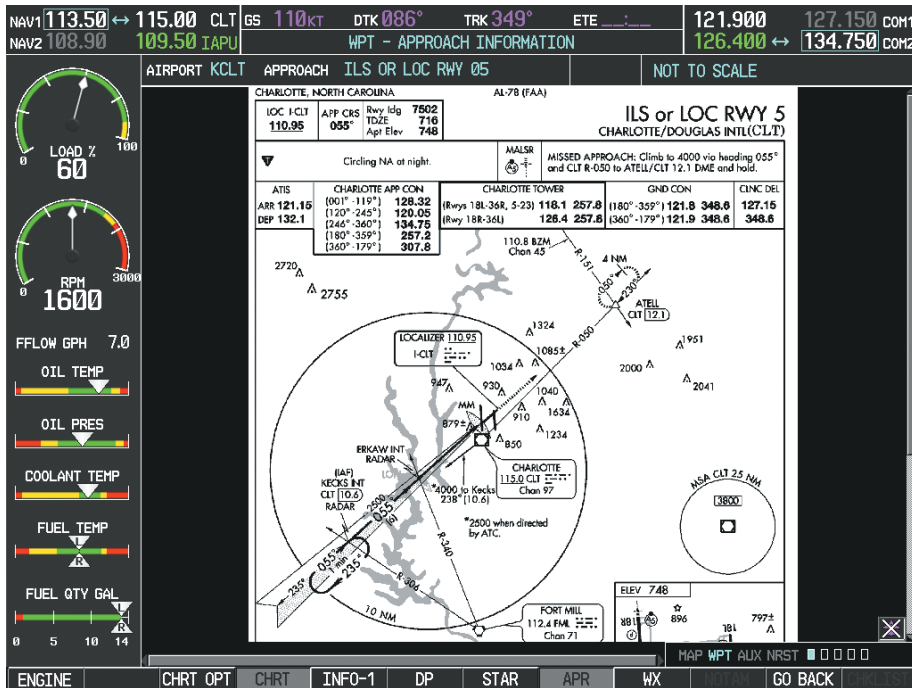

Figure 8-58 Approach Information Page

Pressing the **WX** Softkey shows the airport weather frequency information, when available, and includes weather data such as METAR and TAF from the XM Data Link Receiver. Weather information is available only when an XM Data Link Receiver is installed and the XM WX Satellite Weather subscription is current.

**Selecting Additional Information:**

- 1) While viewing the Airport Taxi Diagram, press the **WX** Softkey to display the information windows (AIRPORT, INFO).
- 2) Press the **FMS** Knob to activate the cursor.
- 3) Turn the large **FMS** Knob to highlight the INFO Box.
- 4) Turn the small **FMS** Knob to select the INFO Box choices. When the INFO Box is selected the G1000 softkeys are blank. If multiple choices are available, scroll to the desired choice with the large **FMS** Knob and press the **ENT** Key to complete the selection.
- 5) Press the **FMS** Knob again to deactivate the cursor.



Figure 8-59 Weather Information Page, WX Softkey Selected

Pressing the **GO BACK** Softkey reverts to the previous page (Navigation Map Page or Flight Plan Page).

## CHART OPTIONS

Pressing the **CHRT OPT** Softkey displays the next level of softkeys, the chart options level (Figure 8-48). Pressing the **ALL** Softkey shows the complete chart on the screen.

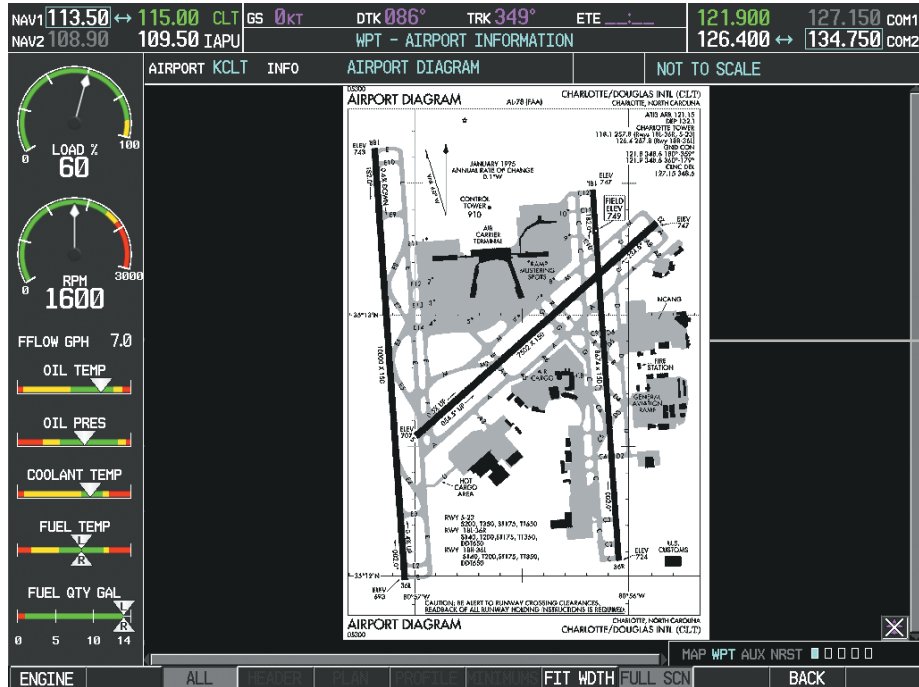
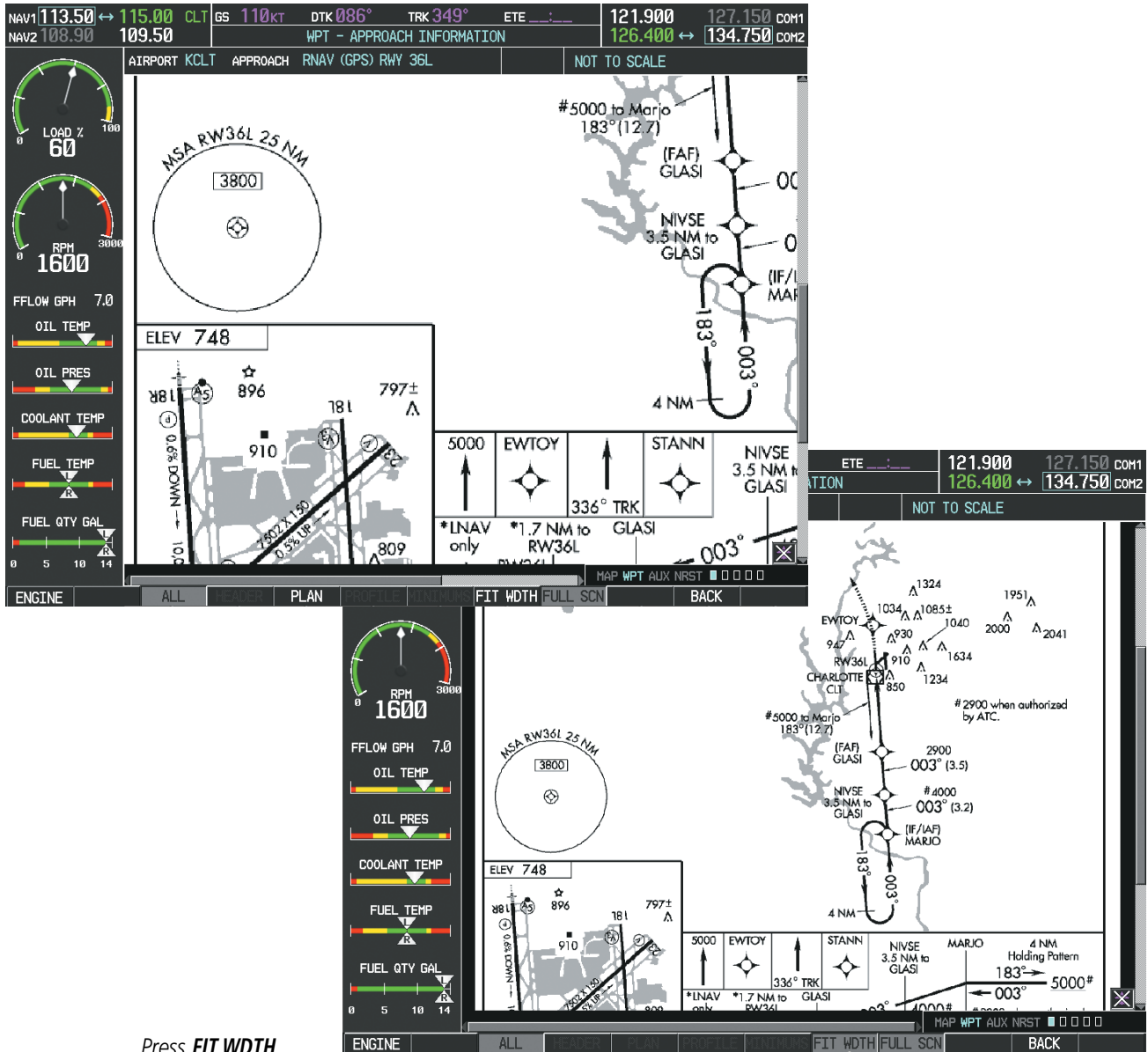

Figure 8-60 Airport Information Page, ALL View Selected

Pressing the **FIT WIDTH** Softkey fits the width of the chart in the display viewing area. In the example shown, the chart at close range is replaced with the full width chart.



Press **FIT WIDTH** Softkey to Show Full Chart Width

Figure 8-61 Approach Information Page, FIT WIDTH Softkey Selected

Pressing the **FULL SCN** Softkey alternates between removing and replacing the data window to the right.

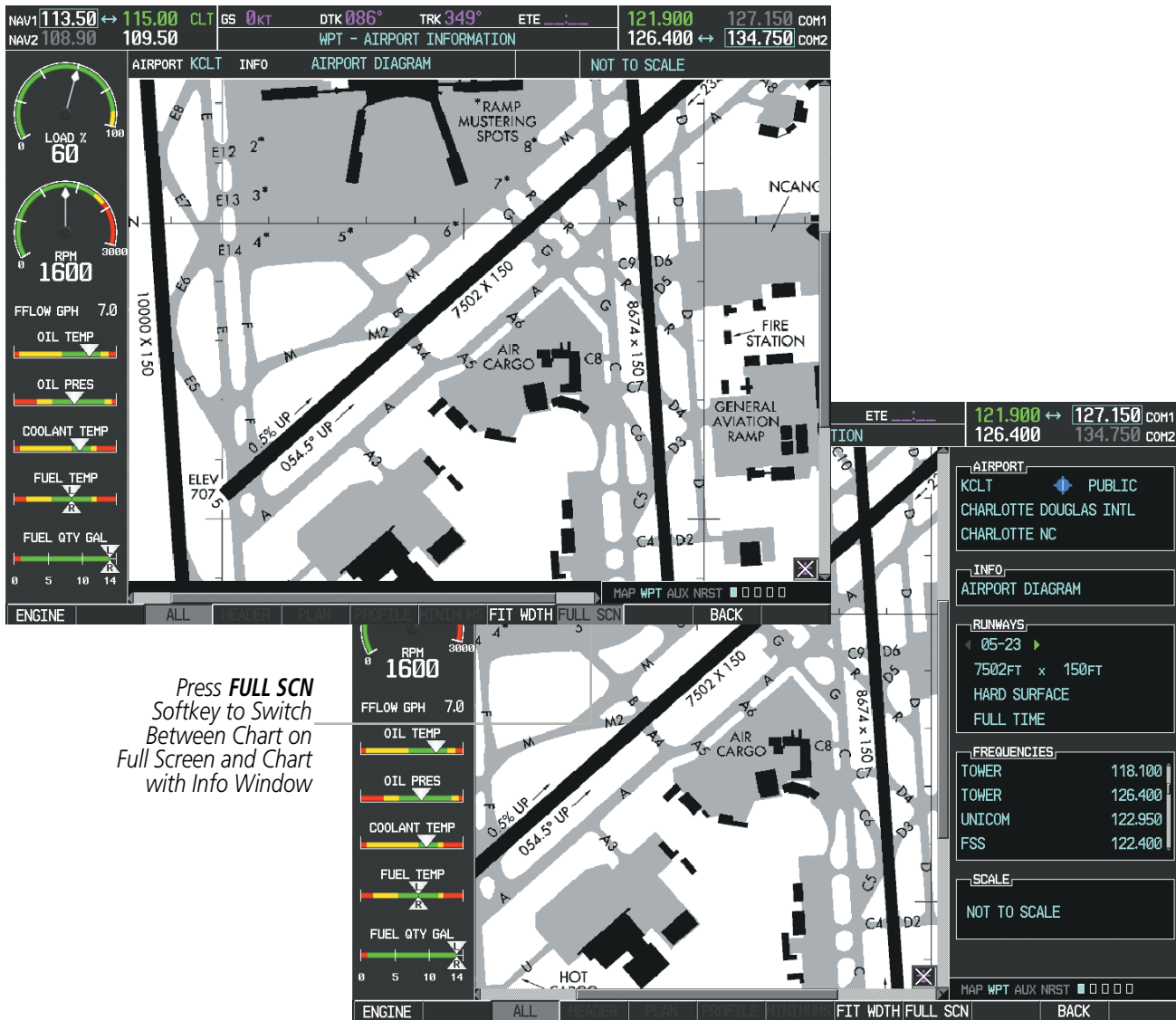

Figure 8-62 Airport Information Page, Full Screen and Info Window

Pressing the **BACK** Softkey, or waiting for 45 seconds reverts to the chart selection softkeys.

The full screen view can also be selected by using the page menu option.

**Selecting full screen On or Off:**

- 1) While viewing a terminal chart press the **MENU** Key to display the Page Menu OPTIONS.
- 2) Turn the large **FMS** Knob to highlight the Chart Setup Menu Option and press the **ENT** Key.
- 3) Turn the large **FMS** Knob to move between the FULL SCREEN and COLOR SCHEME Options.
- 4) Turn the small **FMS** Knob to choose between the On and Off Full Screen Options.

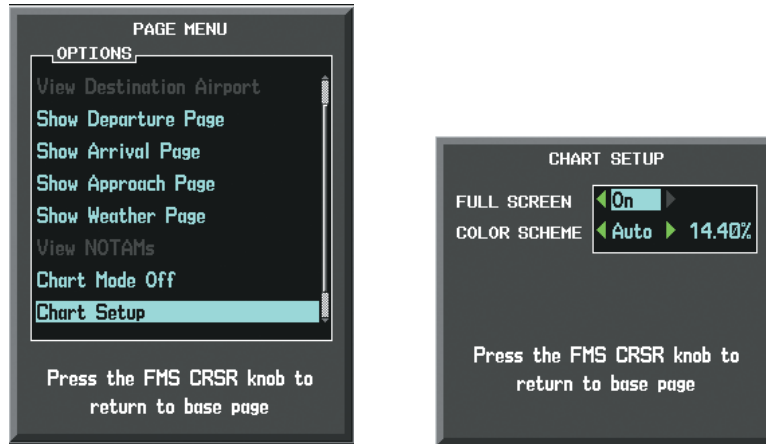

*Chart Setup Option*

*Full Screen On/Off Selection*

**Figure 8-63 Page Menus**



## DAY/NIGHT VIEW

FliteCharts can be displayed on a white or black background for day or night viewing. The Day View offers a better presentation in a bright environment. The Night View gives a better presentation for viewing in a dark environment. When the CHART SETUP Box is selected the G1000 softkeys are blank.

### Selecting Day, Night, or Automatic View:

- 1) While viewing a terminal chart press the **MENU** Key to display the Page Menu OPTIONS.
- 2) Turn the large **FMS** Knob to highlight the Chart Setup Menu Option and press the **ENT** Key.

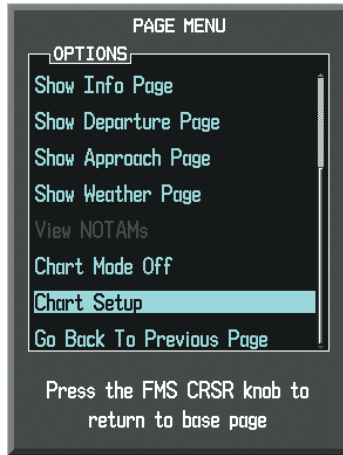

Figure 8-64 Waypoint Information Page, OPTIONS Menu

- 3) Turn the large **FMS** Knob to move to the COLOR SCHEME Option (Figure 8-65).
- 4) Turn the small **FMS** Knob to choose between Day, Auto, and Night Options.
- 5) If Auto Mode is selected, turn the large **FMS** Knob to select the percentage field. Use the small **FMS** Knob to change the percentage value. The percentage value is the day/night crossover point based on the percentage of backlighting intensity. For example, if the value is set to 15%, the day/night display changes when the display backlight reaches 15% of full brightness.

The display must be changed in order for the new setting to become active. This may be accomplished by selecting another page or changing the display range.

- 6) Press the **FMS** Knob when finished to remove the Chart Setup Menu.



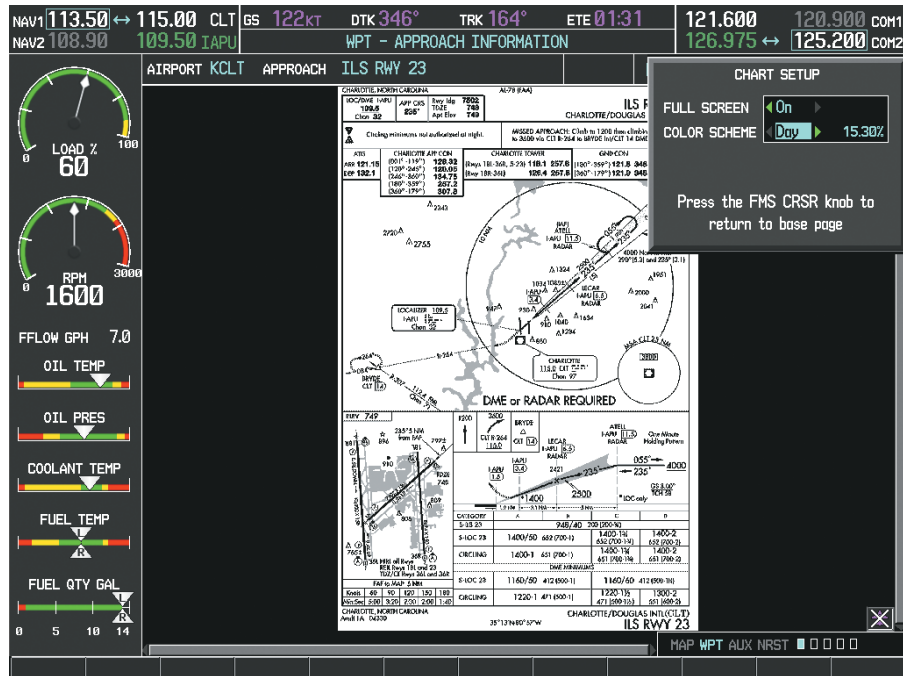

Figure 8-65 Approach Information Page, Day View

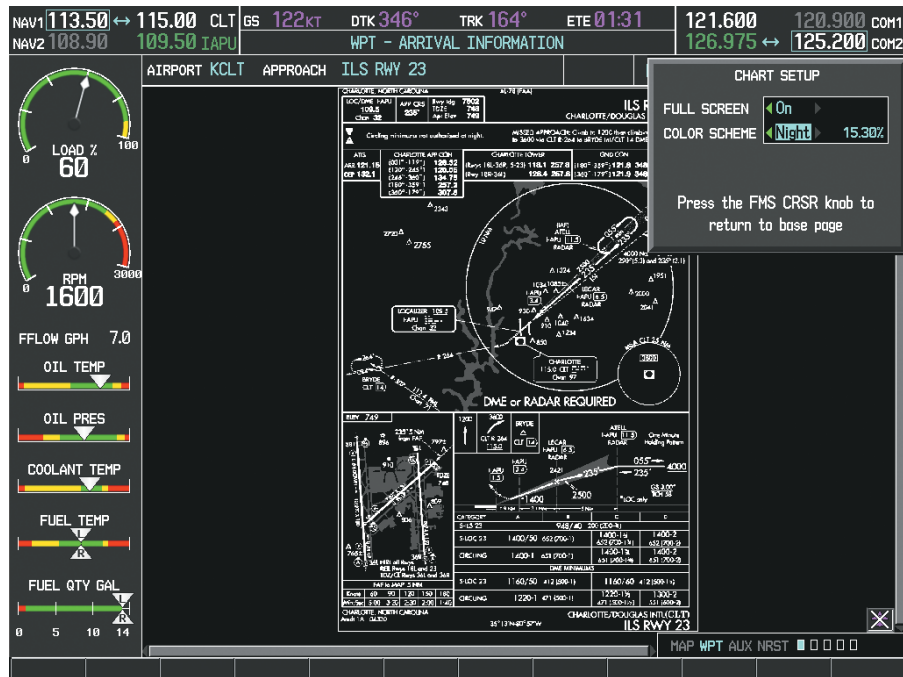

Figure 8-66 Approach Information Page, Night View

SYSTEM OVERVIEW

FLIGHT INSTRUMENTS

EIS

AUDIO PANEL & CNS

FLIGHT MANAGEMENT

HAZARD AVOIDANCE

AFCS

ADDITIONAL FEATURES

APPENDICES

INDEX

## FLITECHARTS CYCLE NUMBER AND EXPIRATION DATE

FliteCharts data is revised every 28 days. Charts are still viewable during a period that extends from the cycle expiration date to the disables date. FliteCharts is disabled 180 days after the expiration date and are no longer available for viewing upon reaching the disables date. When turning on the system, the Power-up Page displays the current status of the FliteCharts database. See the table below for the various FliteCharts Power-up Page displays and the definition of each.

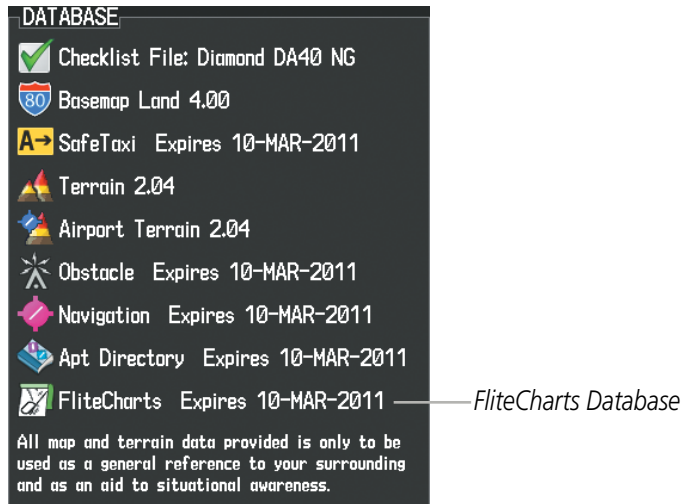

Figure 8-67 Power-up Page, FliteCharts Database

Power-up Page Display	Definition
Blank Line	system is not configured for FliteCharts. Contact a Garmin-authorized service center for configuration.
Chart Data: N/A	System is configured for FliteCharts but no chart database is installed. Refer to Updating Garmin Databases in Appendix B for the FliteCharts database
FliteCharts Expires 10-MAR-2011	Normal operation. FliteCharts database is valid and within current cycle.
Chart data is out of date!	FliteCharts database is beyond the expiration date, but still within the 180 day viewing period.
Chart data is disabled.	FliteCharts database has timed out. Database is beyond 180 days after expiration date. FliteCharts database is no longer available for viewing.

Table 8-3 FliteCharts Power-up Page Annunciations and Definitions

Other possible AUX - System Status page conditions are shown in Figure 8-68. ‘FliteCharts Expires’ plus a date in white, indicates the chart database is current. ‘Chart data is out of date!’ in yellow, indicates charts are still viewable, but approaching the disable date.

When the 180 day grace period has expired, 'Chart data is disabled.' in yellow indicates that the FliteCharts database has expired and is no longer viewable. 'Chart Data: N/A' appears in white if no FliteCharts data is available on the database card or no database card is inserted.

FliteCharts time critical information can also be found on the AUX - System Status page. The FliteCharts database REGION, CYCLE number, EFFECTIVE, EXPIRES, and DISABLES dates of the subscription appear in either blue or yellow text. Dates shown in blue are current data. Dates shown in yellow indicate the data is not within the current subscription period.

FliteCharts becomes inoperative 180 days after the FliteCharts EXPIRES date is reached, and is no longer available for viewing. This date is shown as the DISABLES date. After the disable date the **SHW CHRT** Softkey label appears subdued and is unavailable until a revised issue of FliteCharts is installed.

**NOTE:** A subdued softkey label indicates the function is disabled.

Press the **MFD1 DB** Softkey to place the cursor in the DATABASE window. Scroll through the listed information by turning the **FMS** Knob or pressing the **ENT** Key until the FliteCharts database information is shown.

The FliteCharts database cycle number shown in the figure, 1102, is deciphered as follows:

11 – Indicates the year 2011

02 – Indicates the second issue of the FliteCharts database for the year

The FliteCharts EFFECTIVE date 10-FEB-11 is the first date that this database is current.

The FliteCharts EXPIRES date 10-MAR-11 is the last date that this database is current.

The DISABLES date 06-SEP-11 is the date that this database becomes inoperative.

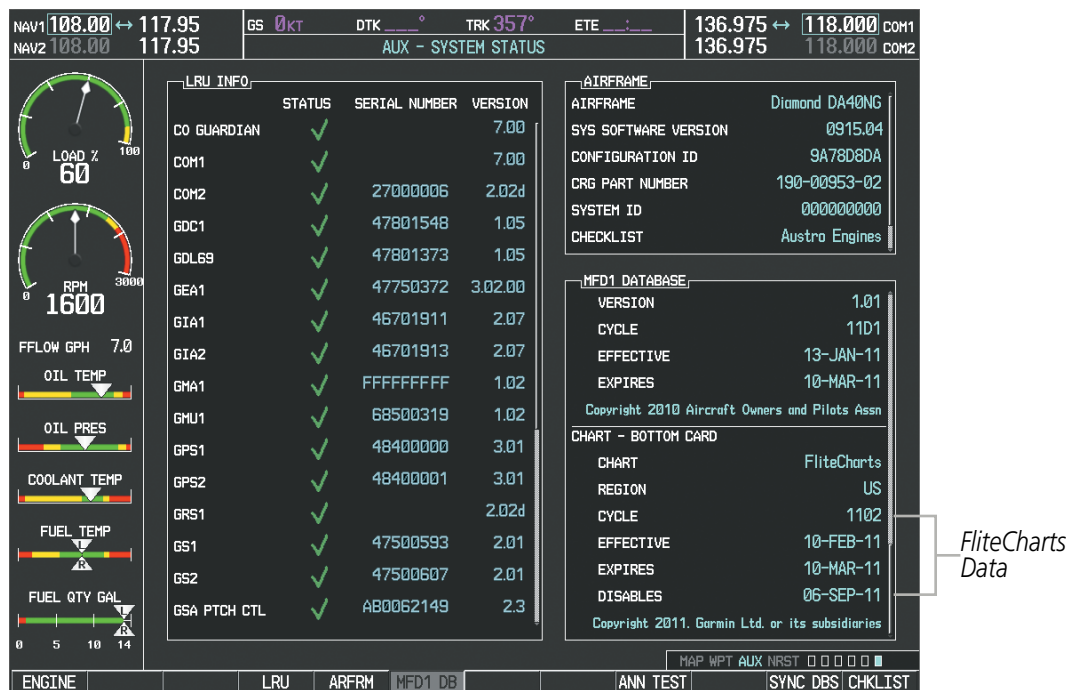

Figure 8-68 AUX – System Status Page, FliteCharts Current and Available

The FliteCharts database is provided from Garmin. Refer to Updating Garmin Databases in Appendix B for instructions on revising the FliteCharts database.

The other four possible AUX - System Status page conditions are shown here. The EFFECTIVE date, in yellow, indicates the current date precedes the date the FliteCharts database becomes effective. The EXPIRES date, in yellow, is the revision date for the next database cycle. The DISABLES date, in yellow, is the date that this database cycle is no longer viewable. NOT AVAILABLE in blue, indicate the FliteCharts database is not available on the database card or no database card is inserted.

MFD1 DATABASE	MFD1 DATABASE	MFD1 DATABASE
VERSION 1.01	VERSION 1.01	VERSION 1.01
CYCLE 11D1	CYCLE 11D1	CYCLE 11D1
EFFECTIVE 13-JAN-11	EFFECTIVE 13-JAN-11	EFFECTIVE 13-JAN-11
EXPIRES 10-MAR-11	EXPIRES 10-MAR-11	EXPIRES 10-MAR-11
Copyright 2010 Aircraft Owners and Pilots Assn	Copyright 2010 Aircraft Owners and Pilots Assn	Copyright 2010 Aircraft Owners and Pilots Assn
CHART - BOTTOM CARD	CHART - BOTTOM CARD	CHART - BOTTOM CARD
CHART FliteCharts	CHART FliteCharts	CHART FliteCharts
REGION US	REGION US	REGION US
CYCLE 1102	CYCLE 1102	CYCLE 1102
EFFECTIVE 10-FEB-11	EFFECTIVE 10-FEB-11	EFFECTIVE 10-FEB-11
EXPIRES 10-MAR-11	EXPIRES 10-MAR-11	EXPIRES 10-MAR-11
DISABLES 06-SEP-11	DISABLES 06-SEP-11	DISABLES 06-SEP-11
Copyright 2011. Garmin Ltd. or its subsidiaries	Copyright 2011. Garmin Ltd. or its subsidiaries	Copyright 2011. Garmin Ltd. or its subsidiaries

*Current Date is Before Effective Date*

*FliteCharts Expired, but is not Disabled*

*FliteCharts Database is Disabled*

MFD1 DATABASE
VERSION 1.01
CYCLE 11D1
EFFECTIVE 13-JAN-11
EXPIRES 10-MAR-11
Copyright 2010 Aircraft Owners and Pilots Assn
CHART - UNKNOWN
CHART FliteCharts
REGION NOT AVAILABLE
CYCLE NOT AVAILABLE
EFFECTIVE -- -- -- --
EXPIRES -- -- -- --
DISABLES -- -- -- --

*FliteCharts Database is Not Available*

**Figure 8-69 AUX – System Status Page, FliteCharts Database Status**

## 8.5 AOPA AIRPORT DIRECTORY

The Aircraft Owners and Pilots Association (AOPA) Airport Directory database offers detailed information regarding services, hours of operation, lodging options, and more. This information is viewed on the Airport Directory Page as shown in Figure 8-70.

### Selecting the Airport Directory Page:

- 1) Turn the large **FMS** Knob to select the 'WPT' page group.
- 2) Turn the small **FMS** Knob to select the AIRPORT INFORMATION Page. Initially, information for the airport closest to the aircraft's present position is displayed.
- 3) If necessary, press the INFO softkey until **INFO-2** is displayed.



Figure 8-70 AOPA Information on the Airport Information Page

## AOPA DATABASE CYCLE NUMBER AND REVISION

The AOPA Airport Directory database is revised four times per year. Check fly.garmin.com for the current database. The Airport Directory is always available for use after the expiration date. When turning on the system, the Power-up Page indicates whether the databases are current, out of date, or not available.

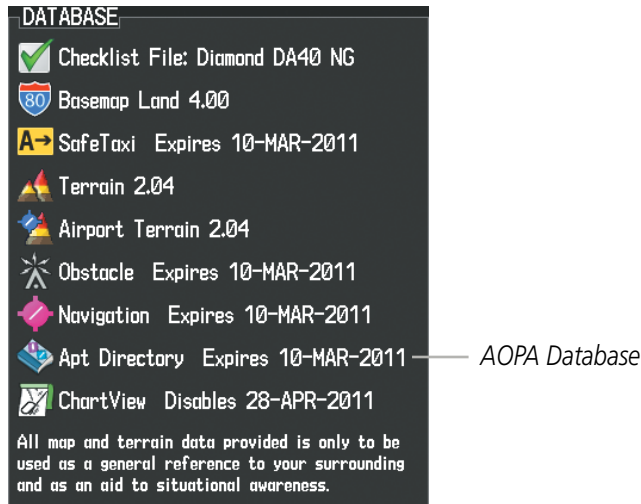

Figure 8-71 Power-up Page, Airport Directory Database

Power-up Page Display	Definition
Apt Directory Expires 10-MAR-2011	Normal operation. AOPA Airport Directory database is valid and within current cycle.
Apt Directory Expires 10-MAR-2011	AOPA Airport Directory database has expired.
Apt Directory N/A	Database card contains no AOPA Airport Directory data.

Table 8-4 Airport Directory Annunciation Definitions

The Airport Directory Region, Version, Cycle, Effective date and Expires date of the database cycle can also be found on the AUX - System Status page, as seen in Figure 8-72.



Press the **MFD1 DB** Softkey to place the cursor in the DATABASE window. Scroll through the listed information by turning the **FMS** Knob or pressing the **ENT** Key until the Airport Directory database information is shown.

The Airport Directory database cycle number shown in the figure, 11D1, is deciphered as follows:

11 – Indicates the year 2011

D – Indicates the data is for Airport Directory

1 – Indicates the first issue of the Airport Directory database for the year

The Airport Directory EFFECTIVE date 13-JAN-11 is the beginning date for the current database cycle. The Airport Directory EXPIRES date 10-MAR-11 is the revision date for the next database cycle.



**Figure 8-72 AUX – System Status Page, AOPA Airport Directory Database Status**

Airport Directory information appears in blue and yellow text. The EFFECTIVE date appears in blue when data is current and in yellow when the current date is before the effective date. The EXPIRES date appears in blue when data is current and in yellow when expired (Table 8-4). NOT AVAILABLE appears in blue in the REGION field if Airport Directory data is not available on the database card. An expired Airport Directory database is not disabled and will continue to function indefinitely.



## 8.6 SIRIUSXM SATELLITE RADIO (OPTIONAL)



**NOTE:** Refer to the Hazard Avoidance Section for information about XM WX Satellite Weather products.

The optional SiriusXM Satellite Radio entertainment feature of the GDL 69A Data Link Receiver is available for the pilot's and passengers' enjoyment. The GDL 69A can receive SiriusXM Satellite Radio entertainment services at any altitude throughout the Continental U.S. Entertainment audio is not available on the GDL 69 Data Link Receiver.

SiriusXM Satellite Radio offers a variety of radio programming over long distances without having to constantly search for new stations. Based on signals from satellites, coverage far exceeds land-based transmissions. SiriusXM Satellite Radio services are subscription-based. For more information on specific service packages, visit [www.siriusxm.com](http://www.siriusxm.com).

### ACTIVATING SIRIUSXM SATELLITE RADIO SERVICES

The service is activated by providing SiriusXM Satellite Radio with either one or two coded IDs, depending on the equipment. Either the Audio Radio ID or the Data Radio ID, or both, must be provided to SiriusXM Satellite Radio to activate the entertainment subscription.

It is not required to activate both the entertainment and weather service subscriptions with the GDL 69A. Either or both services can be activated. SiriusXM Satellite Radio uses one or both of the coded IDs to send an activation signal that, when received by the GDL 69A, allows it to play entertainment programming.

These IDs are located:

- On the label on the back of the Data Link Receiver
- On the XM Information Page on the MFD (Figure 8-73)
- On the XM Satellite Radio Activation Instructions included with the unit (available at [www.garmin.com](http://www.garmin.com), P/N 190-00355-04)

Contact the installer if the Data Radio ID and the Audio Radio ID cannot be located.



**NOTE:** The **LOCK** Softkey on the XM Information Page (Auxiliary Page Group) is used to save GDL 69A activation data when the SiriusXM services are initially set up. It is not used during normal SiriusXM Satellite Radio operation, but there should be no adverse effects if inadvertently pressed during flight. Refer to the GDL 69/69A XM Satellite Radio Activation Instructions (190-00355-04, Rev H or later) for further information.

**Activating the SiriusXM Satellite Radio services:**

- 1) Contact SiriusXM Satellite Radio. Follow the instructions provided by SiriusXM Satellite Radio services.
- 2) Select the Auxiliary Page Group.
- 3) Select the next to last page in the AUX Page Group.
- 4) Press the **INFO** Softkey to display the XM Information Page.
- 5) Verify that the desired services are activated.
- 6) Press the **LOCK** Softkey.
- 7) Turn the large **FMS** Knob to highlight YES.
- 8) To complete activation, press the **ENT** Key.

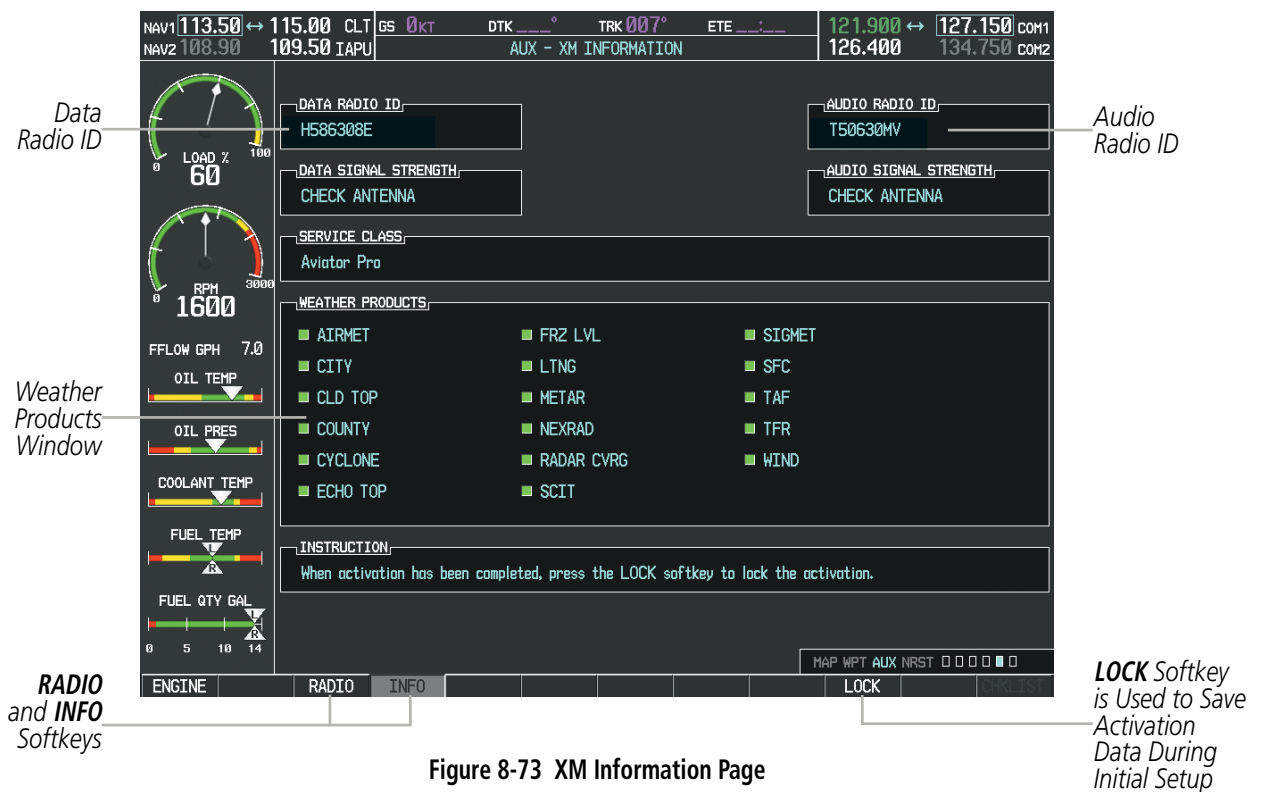

Figure 8-73 XM Information Page

If XM WX Satellite Weather services have not been activated, all the weather product boxes are blank on the XM Information Page and a yellow Activation Required message is displayed in the center of the Weather Data Link Page (Map Page Group). The Service Class refers to the groupings of weather products available for subscription.

## USING SIRIUSXM SATELLITE RADIO

The optional GRC 10 Remote Control Unit provides control of the SiriusXM Satellite Radio functions independent of the MFD controls. See the GRC 10 User’s Guide for details.

The XM Radio Page provides information and control of the audio entertainment features of the SiriusXM Satellite Radio.

### Selecting the XM Radio Page:

- 1) Turn the large **FMS** Knob to select the Auxiliary Page Group.
- 2) Turn the small **FMS** Knob to select the displayed AUX - XM Information Page.
- 3) Press the **RADIO** Softkey to show the XM Radio Page where audio entertainment is controlled.



Figure 8-74 XM Radio Page

### ACTIVE CHANNEL AND CHANNEL LIST

The Active Channel Box on the XM Radio Page displays the currently selected channel that the SiriusXM Radio is using.

The Channels List Box of the XM Radio Page shows a list of the available channels for the selected category. Channels can be stepped through one at a time or may be selected directly by channel number.

### Selecting a channel from the channel list:

- 1) While on the XM Radio Page, press the **CHNL** Softkey.
- 2) Press the **CH +** Softkey to go up through the list in the Channel Box, or move down the list with the **CH –** Softkey.

Or:

- 1) Press the **FMS** Knob to highlight the channel list and turn the large **FMS** Knob to scroll through the channels.
- 2) Press the **ENT** Key to activate the selected channel.

#### Selecting a channel directly:

- 1) While on the XM Radio Page, press the **CHNL** Softkey.
- 2) Press the **DIR CH** Softkey. The channel number in the Active Channel Box is highlighted.
- 3) Press the numbered softkeys located on the bottom of the display to directly select the desired channel number.
- 4) Press the **ENT** Key to activate the selected channel.

## CATEGORY

The Category Box of the XM Radio Page displays the currently selected category of audio. Categories of channels such as jazz, rock, or news can be selected to list the available channels for a type of music or other contents. One of the optional categories is PRESETS to view channels that have been programmed.

#### Selecting a category:

- 1) Press the **CATGRY** Softkey on the XM Radio Page.
- 2) Press the **CAT +** and **CAT -** Softkeys to cycle through the categories.

Or:

Turn the small **FMS** Knob to display the Categories list. Highlight the desired category with the small **FMS** Knob and press the **ENT** Key. Selecting All Categories places all channels in the list.



Figure 8-75 Categories List

## PRESETS

Up to 15 channels from any category can be assigned a preset number. The preset channels are selected by pressing the **PRESETS** and **MORE** Softkeys. Then the preset channel can be selected directly and added to the channel list for the Presets category.

### Setting a preset channel number:

- 1) On the XM Radio Page, while listening to an Active Channel that is wanted for a preset, press the **PRESETS** Softkey to access the first five preset channels (**PS1 - PS5**).
- 2) Press the **MORE** Softkey to access the next five channels (**PS6 – PS10**), and again to access the last five channels (**PS11 – PS15**). Pressing the **MORE** Softkey repeatedly cycles through the preset channels.
- 3) Press the **SET** Softkey.
- 4) Press any one of the (**PS1 - PS15**) softkeys to assign a number to the active channel.

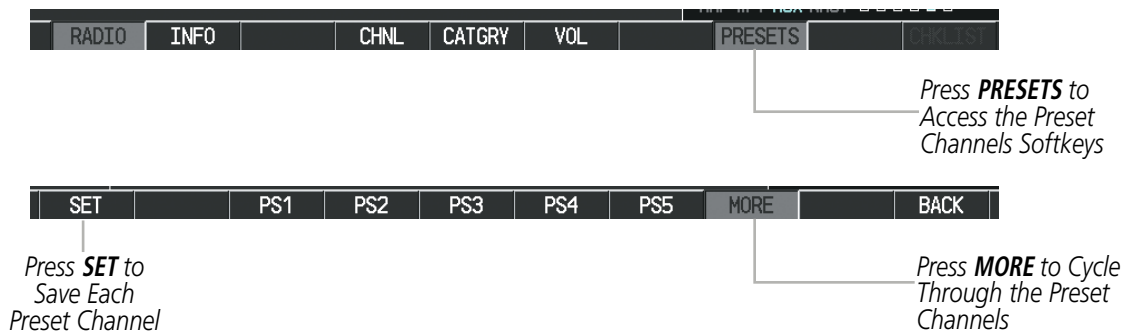

Figure 8-76 Accessing and Selecting Preset Channels

Pressing the **BACK** Softkey, or waiting during 45 seconds of softkey inactivity, returns the system to the top level softkeys.

## VOLUME

Radio volume is shown as a percentage of full volume. Volume level is controlled by pressing the **VOL** Softkey, which brings up the **MUTE** Softkey and the volume increase and decrease softkeys.

### Adjusting the volume:

- 1) With the XM Radio Page displayed, press the **VOL** Softkey.
- 2) Press the **VOL –** Softkey to reduce volume or press the **VOL +** Softkey to increase volume. (Once the **VOL** Softkey is pressed, the volume can also be adjusted using the small **FMS** Knob.)
- 3) Press the **MUTE** Softkey to mute the audio. Press the **MUTE** Softkey again to unmute the audio.

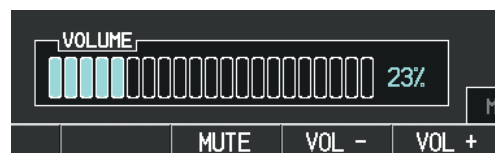

Figure 8-77 Volume Control

## 8.7 SCHEDULER

The Scheduler feature can be used to enter and display reminder messages (e.g., Change oil, Switch fuel tanks, or Altimeter-Transponder Check) in the Messages Window on the PFD. Messages can be set to display based on a specific date and time (event), once the message timer reaches zero (one-time; default setting), or recurrently whenever the message timer reaches zero (periodic). Message timers set to periodic alerting automatically reset to the original timer value once the message is displayed. When power is cycled, all messages are retained until deleted, and message timer countdown is resumed.

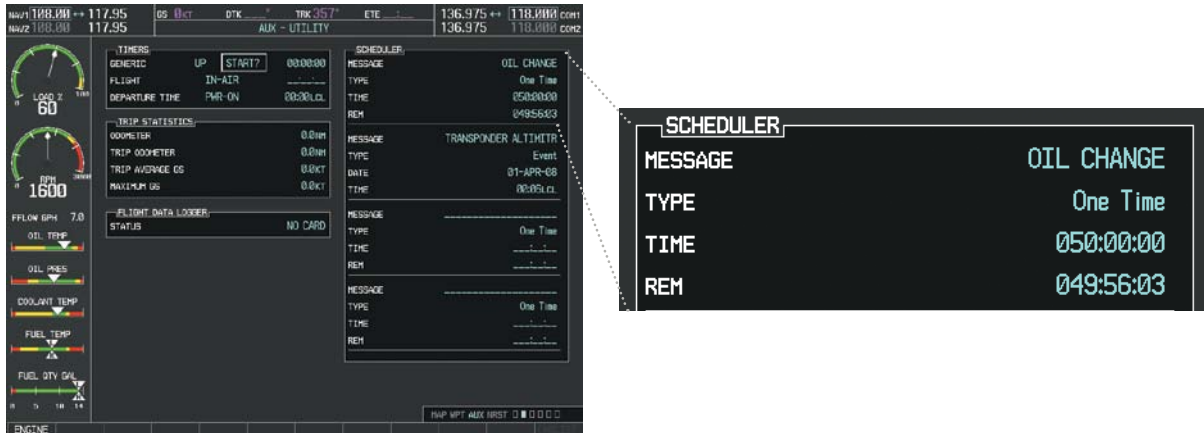

Figure 8-78 Scheduler (Utility Page)

### Entering a scheduler message:

- 1) Select the AUX - Utility Page.
- 2) Press the **FMS** Knob momentarily to activate the flashing cursor.
- 3) Turn the large **FMS** Knob to highlight the first empty scheduler message naming field.
- 4) Use the **FMS** Knob to enter the message text to be displayed in the Messages Window and press the **ENT** Key.
- 5) Press the **ENT** Key again or use the large **FMS** Knob to move the cursor to the field next to Type.
- 6) Turn the small **FMS** Knob to select the message type:
  - Event—Message issued at the specified date/time
  - One-time—Message issued when the message timer reaches zero (default setting)
  - Periodic—Message issued each time the message timer reaches zero
- 7) Press the **ENT** Key again or use the large **FMS** Knob to move the cursor to the next field.
- 8) For periodic and one-time message, use the **FMS** Knob to enter the timer value (HH:MM:SS) from which to countdown and press the **ENT** Key.

- 9) For event-based messages:
  - a) Use the **FMS** Knob to enter the desired date (DD-MM-YY) and press the **ENT** Key.
  - b) Press the **ENT** Key again or use the large **FMS** Knob to move the cursor to the next field.
  - c) Use the **FMS** Knob to enter the desired time (HH:MM) and press the **ENT** Key.
- 10) Press the **ENT** Key again or use the large **FMS** Knob to move the cursor to enter the next message.

**Deleting a scheduler message:**

- 1) Select the AUX - Utility Page.
- 2) Press the **FMS** Knob momentarily to activate the flashing cursor.
- 3) Turn the large **FMS** Knob to highlight the name field of the scheduler message to be deleted.
- 4) Press the **CLR** Key to clear the message text. If the **CLR** Key is pressed again, the message is restored.
- 5) Press the **ENT** Key while the message line is cleared to clear the message text.

Scheduler messages appear in the Messages Window on the PFD. When a scheduler message is waiting, the **ALERTS** Softkey label changes to **ADVISORY**. Pressing the **ADVISORY** Softkey opens the Messages Window and acknowledges the scheduler message. The softkey label reverts to **ALERTS** when pressed. Pressing the **ALERTS** Softkey again removes the Messages Window from the display, and the scheduler message is deleted from the message queue.



Figure 8-79 PFD Messages Window



## 8.8 ELECTRONIC CHECKLISTS (OPTIONAL)

**NOTE:** The checklists presented here are for example only and may not reflect checklists actually available for the Diamond DA40NG. This material is not intended to replace the checklist information presented in the AFM or the Pilot Safety and Warning Supplements document.

**NOTE:** Garmin is not responsible for the content of checklists. Diamond DA40NG checklists are created, modified, and updated by the aircraft manufacturer.

The optional checklist functions are displayed on two levels of softkeys that are available on any MFD page.

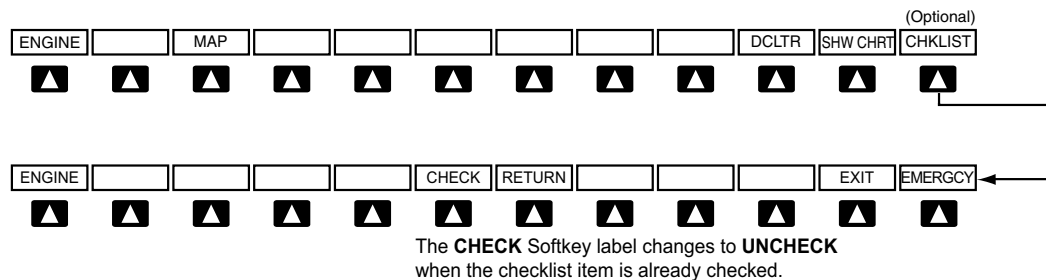

Figure 8-80 Checklist Softkeys

The MFD is able to display optional electronic checklists which allow the pilot to quickly find the proper procedure on the ground and during each phase of flight. The system accesses the checklists from an SD card inserted into the top card slot of the MFD. If the SD card contains an invalid checklist file or no checklist, the Power-up Page messages display 'Checklist File: Invalid' or 'Checklist File: N/A' (not available) and the **CHKLST** Softkey is not available.

The following colors are used for checklist items:

- Light Blue - Items not selected or checked
- White - Item is selected
- Green - Item has been checked
- Gray - General notes
- Yellow - Caution notes
- Red - Warning notes

### Accessing and navigating checklists:

- 1) From any page on the MFD, press the **CHKLST** Softkey or turn the large **FMS** Knob to select the Checklist Page.
- 2) Turn the large **FMS** Knob to select the 'GROUP' field.
- 3) Turn the small **FMS** Knob to select the desired procedure and press the **ENT** Key.
- 4) Turn the large **FMS** Knob to select the 'CHECKLIST' field.
- 5) Turn the small **FMS** Knob to select the desired checklist and press the **ENT** Key. The selected checklist item is indicated with white text surrounded by a white box.
- 6) Press the **ENT** Key or press the **CHECK** Softkey to check the selected checklist item. The line item turns green and a checkmark is placed in the associated box. The next line item is automatically selected for checking.

Either **FMS** Knob can be used to scroll through the checklist and select the desired checklist item.

Press the **CLR** Key or press the **UNCHECK** Softkey to remove a check mark from an item.

- 7) When all checklist items have been checked, ‘\*Checklist Finished\*’ is displayed in green text at the bottom left of the checklist window and ‘GO TO NEXT CHECKLIST?’ is highlighted. If ‘GO TO NEXT CHECKLIST?’ is selected prior to checking all the checklist items, ‘\*CHECKLIST NOT FINISHED\*’ will be displayed in yellow text.
- 8) Press the **ENT** Key. If ‘GO TO NEXT CHECKLIST?’ is displayed when pressing the **ENT** Key, the next checklist in the group will be displayed. If ‘EXIT CHECKLISTS?’ is displayed when pressing the **ENT** Key, the system will exit the Checklist Page.
- 9) Press the **EXIT** Softkey to exit the Checklist Page and return to the page last viewed. When returning to the Checklist Page after pressing the **EXIT** Softkey, the system will return to the last selected checklist item.

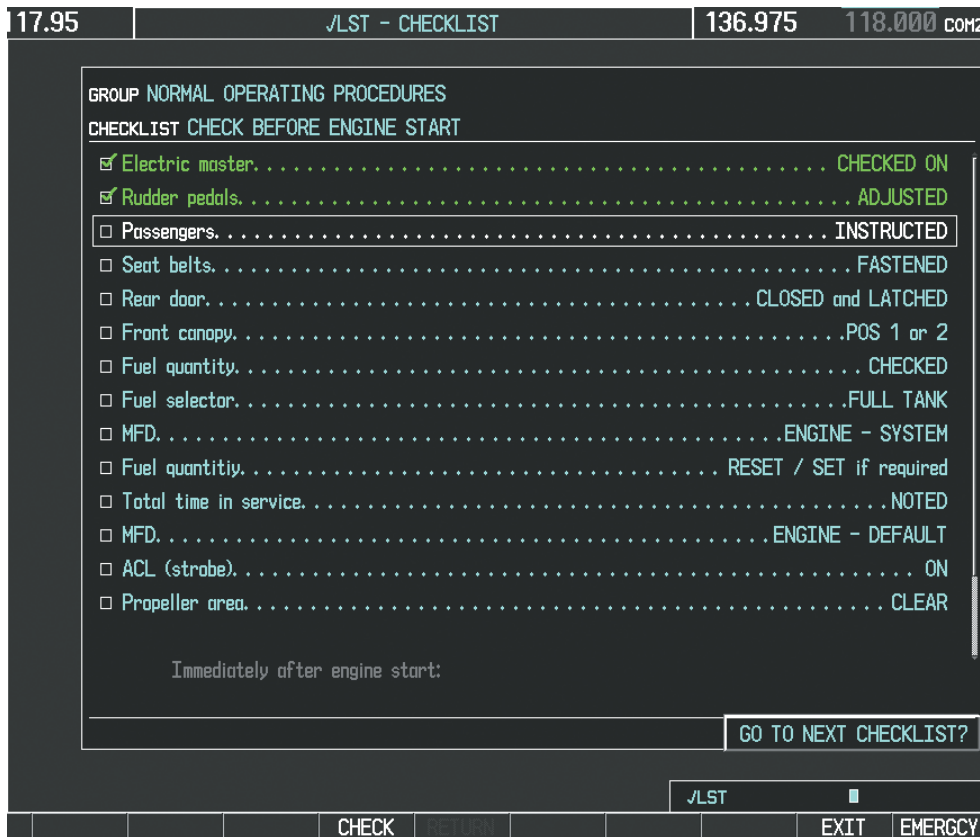

Figure 8-81 Sample Checklist

**Accessing emergency procedures:**

- 1) From any page on the MFD, press the **CHKLIST** Softkey or turn the large **FMS** Knob to select the Checklist Page.
- 2) Press the **EMERGENCY** Softkey.
- 3) Turn the **FMS** Knob to select the desired emergency checklist and press the **ENT** Key.
- 4) Press the **ENT** Key or press the **CHECK** Softkey to check the selected emergency checklist item. The line item turns green and a checkmark is placed in the box next to it. The next line item is automatically highlighted for checking.

Either **FMS** Knob can be used to scroll through the checklist and select the desired checklist item.

Press the **CLR** Key or press the **UNCHECK** Softkey to remove a check mark from an item.

- 5) When all checklist items have been checked, '\*Checklist Finished\*' is displayed in green text at the bottom left of the checklist window and 'GO TO NEXT CHECKLIST?' is highlighted. If 'GO TO NEXT CHECKLIST?' is selected prior to checking all the checklist items, '\*CHECKLIST NOT FINISHED\*' will be displayed in yellow text.
- 6) Press the **ENT** Key to advance to the next checklist.
- 7) Press the **RETURN** Softkey to return to the previous checklist.
- 8) Press the **EXIT** Softkey to exit the Checklist Page and return to the page last viewed.

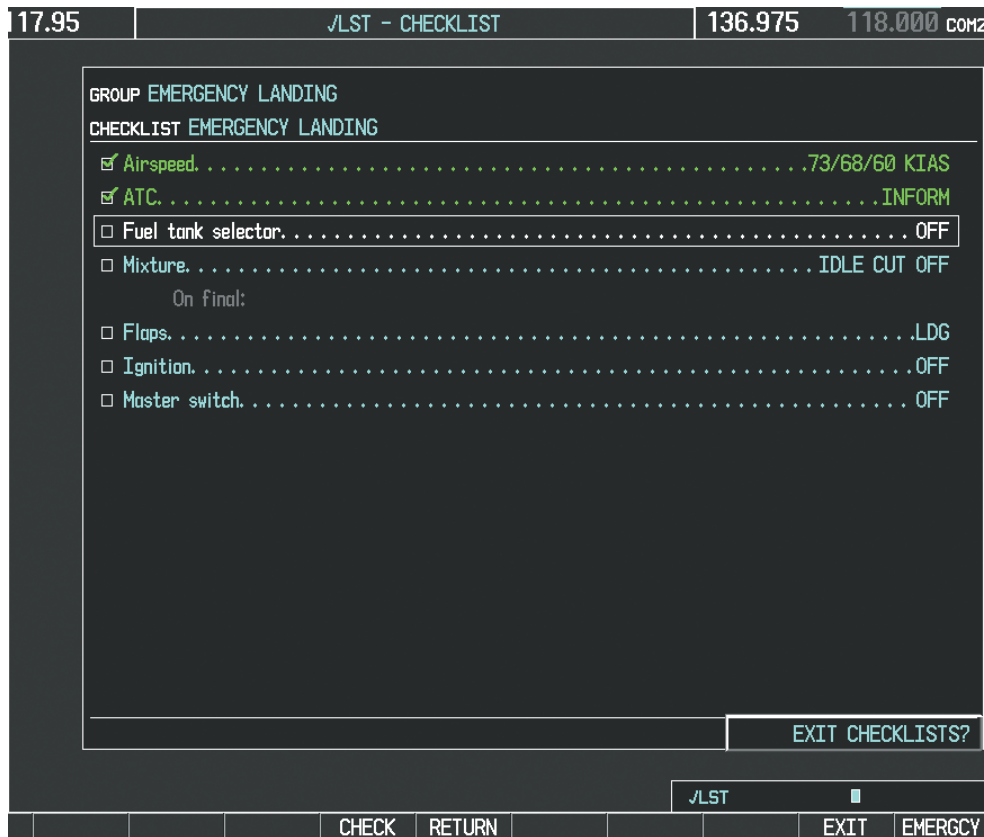

Figure 8-82 Emergency Checklist Page Example

SYSTEM OVERVIEW

FLIGHT INSTRUMENTS

EIS

AUDIO PANEL & CNS

FLIGHT MANAGEMENT

HAZARD AVOIDANCE

AFCS

ADDITIONAL FEATURES

APPENDICES

INDEX

## 8.9 FLIGHT DATA LOGGING



**NOTE:** Some aircraft installations may not provide all aircraft/engine data capable of being logged by the system.

The Flight Data Logging feature will automatically store critical flight and engine data on an SD data card (up to 16GB) inserted into the top card slot of the MFD. Approximately 1,000 flight hours can be recorded for each 1GB of available space on the card.

Data is written to the SD card once each second while the MFD is powered on. All flight data logged on a specific date is stored in a file named in a format which includes the date, time, and nearest airport identifier. The file is created automatically each time the G1000 system is powered on, provided an SD card has been inserted.

The status of the Flight Data Logging feature can be viewed on the AUX-UTILITY Page. If no SD card has been inserted, “NO CARD” is displayed. When data is being written to the SD card, “LOGGING DATA” is displayed.

The .csv file may be viewed with Microsoft Excel® or other spreadsheet applications.

The following is a list of data parameters the G1000 system is capable of logging for the DA40NG aircraft.

- Date
- Time
- GPS altitude (MSL)
- GPS altitude (WGS84 datum)
- Baro-Corrected altitude (feet)
- Baro Correction (in/Hg)
- Indicated airspeed (kts)
- Vertical speed (fpm)
- GPS vertical speed (fpm)
- OAT (degrees C)
- True airspeed (knots)
- Pitch Attitude Angle (degrees)
- Roll Attitude Angle (degrees)
- Lateral and Vertical G Force (g)
- Ground Speed (kts)
- Ground Track (degrees magnetic)
- Latitude (degrees; geodetic; +North)
- Longitude (degrees; geodetic; +East)
- Magnetic Heading (degrees)
- HSI source
- Selected course
- Com1/Com2 frequency
- Nav1/Nav2 frequency
- CDI deflection
- VDI/GP/GS deflection
- Wind Direction (degrees)
- Wind Speed (knots)
- Active Waypoint Identifier
- Distance to next waypoint (nm)
- Bearing to next waypoint (degrees)
- Magnetic variation (degrees)
- Autopilot On/Off
- AFCS roll/pitch modes
- AFCS roll/pitch commands
- GPS fix
- GPS horizontal alert limit
- GPS vertical alert limit
- SBAS GPS horizontal protection level
- SBAS GPS vertical protection level
- Fuel Qty (right & left)(gals)
- Fuel Flow (gph)
- Fuel Pressure (psi)
- Voltage 1 and/or 2
- Amps 1 and/or 2
- Engine RPM
- Oil Pressure (psi)
- Oil Temperature (deg. F)
- Manifold Pressure (in. Hg)
- CHT
- EGT

The file containing the recorded data will appear in the format shown in Figure 8-83. This file can be imported into most computer spreadsheet applications.

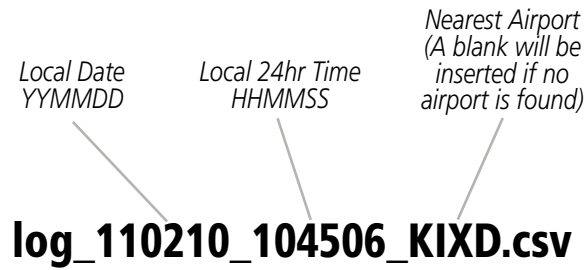

Figure 8-83 Log File Format

Data logging status can be monitored on the AUX-UTILITY Page.

## 8.10 AUXILIARY VIDEO (OPTIONAL)

The G1000 system provides a control and display interface to an optional auxiliary video system.

**NOTE:** Images provided on the Aux-Video page are for supplemental use only.

There are four modes of operation of the auxiliary video display: Full-Screen, Full-Screen with Digital Zoom, Split-Screen with Map, and Split-Screen with Map and Digital Zoom.

### Displaying auxiliary video:

- 1) Turn the large **FMS** Knob to select the AUX page group.
- 2) Turn the small **FMS** Knob to select VIDEO and display the AUX-VIDEO Page.

The video display softkeys shown below appear on the AUX - VIDEO Page.

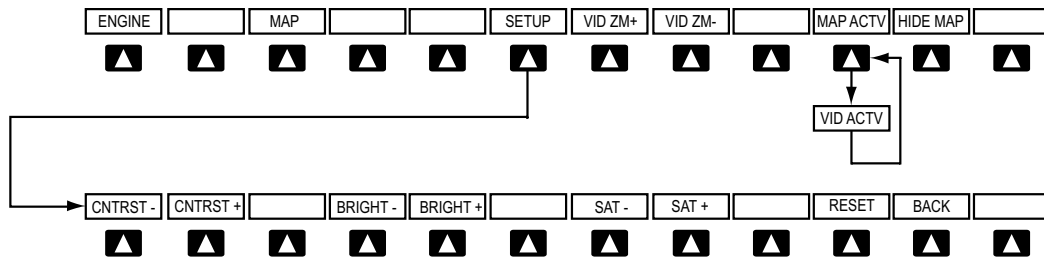

Pressing the **BACK** Softkey returns to the Previous Level Softkeys.

Figure 8-84 Video Display Softkeys

Control of the AUX - VIDEO Page can also be accessed through the Page Menu.



Figure 8-85 AUX - VIDEO Page Menu

### Selecting video menu options:

- 1) While viewing the AUX - VIDEO Page press the **MENU** Key to display the Page Menu **OPTIONS**.
- 2) Turn the large **FMS** Knob to highlight the desired video adjustment option and press the **ENT** Key.

Once the **ENT** key is pressed on any option, the page menu closes and returns to the AUX - VIDEO Page.

## VIDEO SETUP

Video brightness, contrast, and saturation may be adjusted by selecting the setup function. While viewing the setup function softkeys, after 45 seconds of softkey inactivity, the system reverts to the AUX - VIDEO Page softkeys.

### Adjusting the video settings:

- 1) With the AUX-VIDEO Page displayed, press the **SETUP** Softkey.
- 2) Press the **BRIGHT -** or **BRIGHT +**, to adjust display brightness in five percent increments from 0 to 100%.
- 3) Press the **CNTRST-** or **CNTRST +**, to adjust display contrast in five percent increments from 0 to 100%.
- 4) Press the **SAT -** or **SAT +**, to adjust display saturation in five percent increments from 0 to 100%.
- 5) If desired, return the display to the default settings by pressing the **RESET** Softkey.
- 6) Press the **BACK** Softkey to return to the previous softkey level.

## DISPLAY SELECTION

Pressing the **HIDE MAP** Softkey removes the map and displays video on the full screen. The softkey label changes to grey with black characters. Pressing the **HIDE MAP** Softkey again restores the map view and the small video image. The softkey label returns to white characters on a black background.

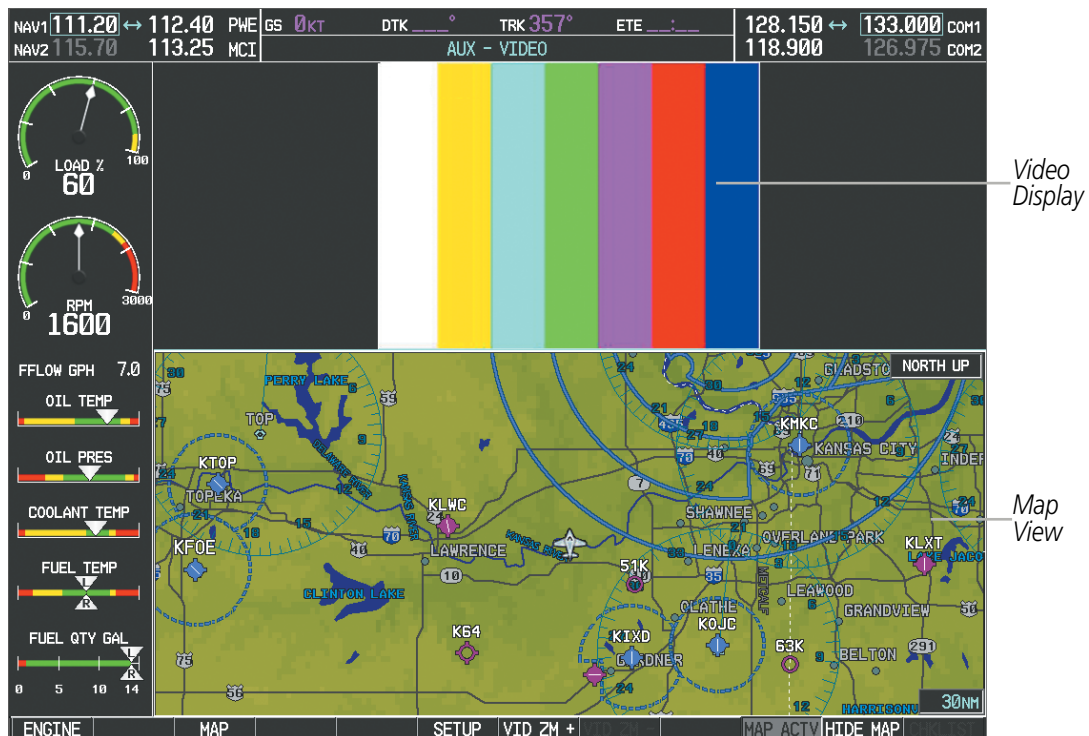

Figure 8-86 AUX - Video Split-Screen



- SYSTEM OVERVIEW
- FLIGHT INSTRUMENTS
- EIS
- AUDIO PANEL & CNS
- FLIGHT MANAGEMENT
- HAZARD AVOIDANCE
- AFCS
- ADDITIONAL FEATURES
- APPENDICES
- INDEX

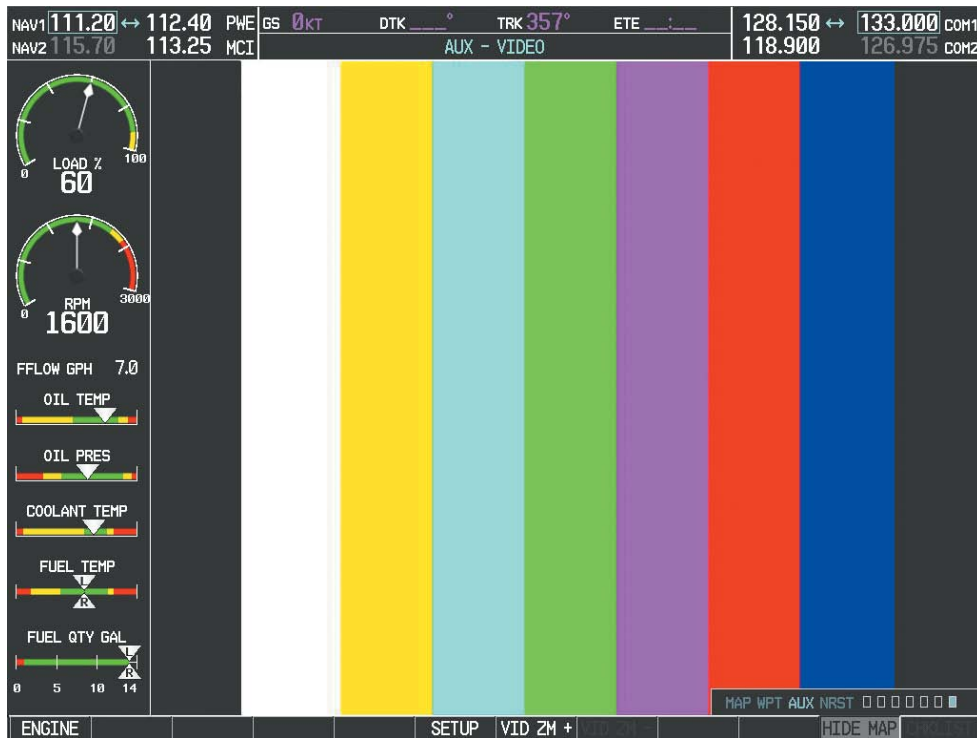

Figure 8-87 Full Screen Video Display

## ZOOM/RANGE

Pressing the **VID ZM +** or **VID ZM -** Softkeys increases or decreases video display magnification between 1x and 10x.

The **RANGE** Knob can be used to increase or decrease the range setting on the map display or zoom in and out on the video display. While in the Split-Screen mode, pressing the **MAP ACTV** or **VID ACTV** Softkey determines which display the **RANGE** Knob adjusts. Pressing the softkey to display **MAP ACTV** allows the **RANGE** Knob to control the range setting of the map display. Pressing the softkey to display **VID ACTV** allows the **RANGE** Knob to control the zoom setting of the video display.

## 8.11 ABNORMAL OPERATION

### SVS TROUBLESHOOTING

SVS is intended to be used with traditional attitude, heading, obstacle, terrain, and traffic inputs. SVS is disabled when valid attitude or heading data is not available for the display. In case of invalid SVS data, the PFD display reverts to the standard blue-over-brown attitude display.

SVS becomes disabled without the following data resources:

- Attitude data
- Heading data
- GPS position data
- 9 Arc-second Terrain data
- Obstacle data
- TAWS function is not available, in test mode, or failed
- The position of the aircraft exceeds the range of the terrain database.

### REVERSIONARY MODE

SVS can be displayed on the Multifunction Display (MFD) in Reversionary Mode. If it is enabled when switching to Reversionary Mode, SVS will take up to 30 seconds to be displayed. The standard, non-SVS PFD display will be shown in the interim.

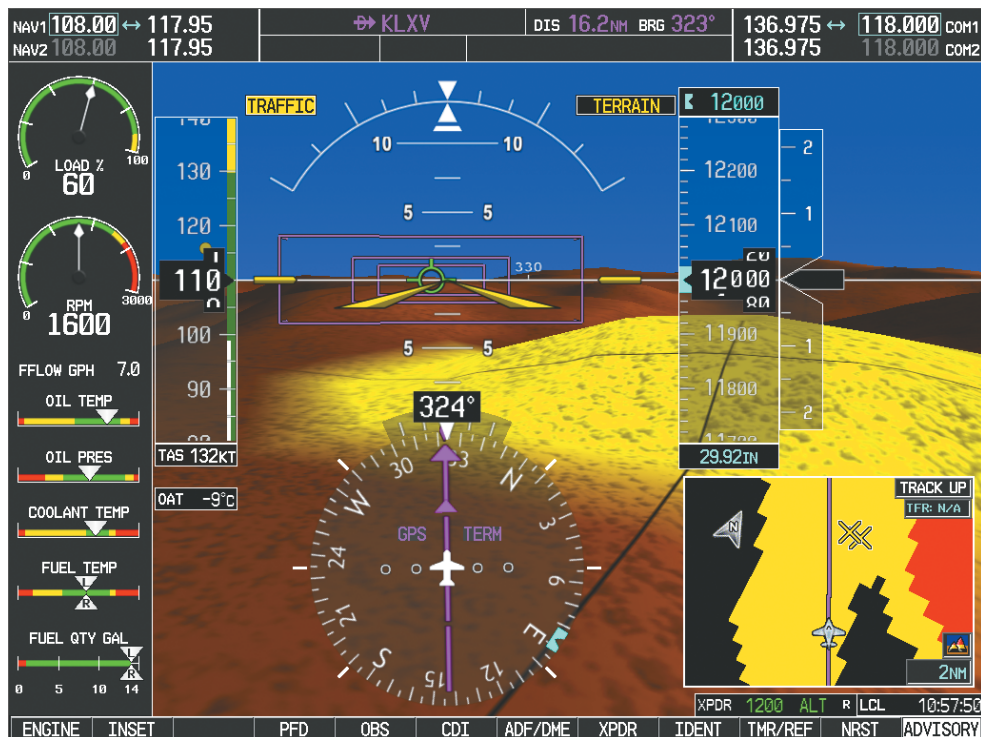

Figure 8-88 SVS Reversionary Mode

SYSTEM OVERVIEW

FLIGHT INSTRUMENTS

EIS

AUDIO PANEL & CNS

FLIGHT MANAGEMENT

HAZARD AVOIDANCE

AFCS

ADDITIONAL FEATURES

APPENDICES

INDEX

## UNUSUAL ATTITUDES

Unusual attitudes are displayed with red chevrons overlaid on the display indicating the direction to fly to correct the unusual attitude condition. The display shows either a brown or blue colored bar at the top or bottom of the screen to represent earth or sky. This is intended to prevent losing sight of the horizon during extreme pitch attitudes.

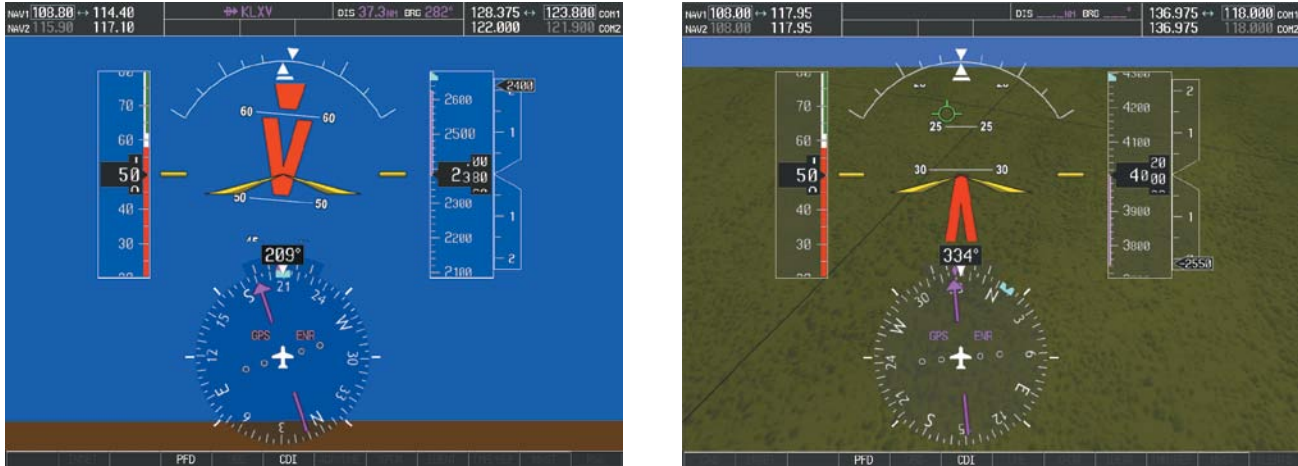

Figure 8-89 Unusual Attitude Display

The blue colored bar is also displayed when terrain gradient is great enough to completely fill the display.



Figure 8-90 Blue Sky Bar with Full Display Terrain

## GDL 69/69A DATA LINK RECEIVER TROUBLESHOOTING

Some quick troubleshooting steps listed below can be performed to find the possible cause of a failure.

- Ensure the owner/operator of the aircraft in which the Data Link Receiver is installed has subscribed to SiriusXM
- Ensure the SiriusXM subscription has been activated
- Perform a quick check of the circuit breakers to ensure that power is applied to the Data Link Receiver
- Ensure that nothing is plugged into the Aux Audio In jack because this would prevent SiriusXM Satellite Radio from being heard

For troubleshooting purposes, check the LRU Information Box on the AUX - System Status Page for Data Link Receiver (GDL 69/69A) status, serial number, and software version number. If a failure has been detected in the GDL 69/69A the status is marked with a red X.

### Selecting the System Status Page:

- 1) Turn the large **FMS** Knob to select the AUX Page Group.
- 2) Turn the small **FMS** Knob to select the System Status Page (the last page in the AUX Page Group).

LRU INFO	STATUS	SERIAL NUMBER	VERSION
COM1	✓		7.00
COM2	✓		7.00
GDC1	✓	47801548	1.05
GDL69	✓	47750372	3.02.00
GEA1	✓	46701911	2.07
GIA1	✓	0000001	0.50
GIA2	✓	48400000	3.01
GMA1	✓	48400001	3.01
GMU1	✓	47500607	2.01
GPS1	✓	0000001	0.50
GPS2	✓	0000002	0.50
GRS1	✗	-----	----
GS1	✗	-----	----
GS2	✗	-----	----
GTX1	✗	-----	----
MFD1	✓	0000002	8.20

Figure 8-91 LRU Information Window on System Status Page

If a failure still exists, the following messages may provide insight as to the possible problem:

Message	Message Location	Description
<b>CHECK ANTENNA</b>	XM Radio Page - active channel field	Data Link Receiver antenna error; service required
<b>UPDATING</b>	XM Radio Page - active channel field	Data Link Receiver updating encryption code
<b>NO SIGNAL</b>	XM Radio Page - active channel field Weather Data Link Page - center of page	Loss of signal; signal strength too low for receiver
<b>LOADING</b>	XM Radio Page - active channel field	Acquiring channel audio or information
<b>OFF AIR</b>	XM Radio Page - active channel field	Channel not in service
<b>---</b>	XM Radio Page - active channel field	Missing channel information
<b>WEATHER DATA LINK FAILURE</b>	Weather Data Link Page - center of page	No communication from Data Link Receiver within last 5 minutes
<b>ACTIVATION REQUIRED</b>	Weather Data Link Page - center of page	SiriusXM subscription is not activated

Table 8-5 GDL 69/69A Data Link Receiver Error Messages

# ANNUNCIATIONS AND ALERTS



**NOTE:** *The Aircraft Flight Manual (AFM) supersedes information found in this document.*

The G1000 Alerting System conveys alerts using the following:

- Annunciation Window:** The Annunciation Window displays abbreviated annunciation text. Text color is based on alert levels described in the following section. The Annunciation Window is located to the right of the Altimeter and Vertical Speed Indicator. All aircraft annunciations can be displayed simultaneously in the Annunciation Window. A white horizontal line separates annunciations that are acknowledged from annunciations that are not yet acknowledged. Higher priority annunciations are displayed towards the top of the window.
- Alerts Window:** The Alerts Window displays text messages for up to 64 prioritized alert messages. Pressing the **ALERTS** Softkey displays the Alerts Window. Pressing the **ALERTS** Softkey a second time removes the Alerts Window from the display. When the Alerts Window is displayed, the **FMS** Knob can be used to scroll through the alert message list.
- Softkey Annunciation:** During certain alerts, the **ALERTS** Softkey may appear as a flashing annunciation to accompany an alert. The **ALERTS** Softkey assumes a new label consistent with the alert level (WARNING, CAUTION, or ADVISORY). By selecting the softkey when flashing an annunciation, the alert is acknowledged. The softkey label then returns to **ALERTS**. If alerts are still present, the **ALERTS** label is displayed in white with black text. Selecting the **ALERTS** Softkey a second time views the alert text messages.
- System Annunciations:** Typically, a large red 'X' appears over instruments whose information is supplied by a failed Line Replaceable Unit (LRU). See the G1000 System Annunciations Section for more information.

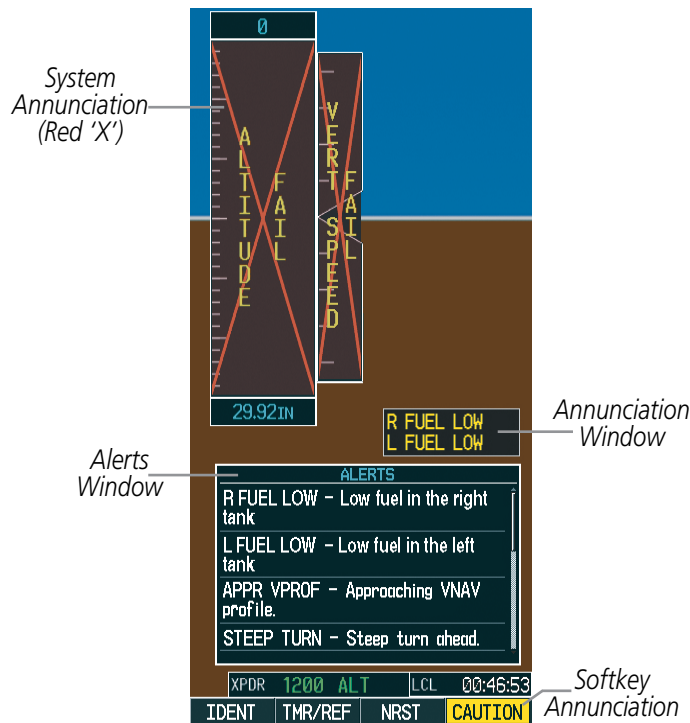

Figure A-1 G1000 Alerting System



- **Audio Alerting System:** The G1000 System issues audio alert tones when specific system conditions are met. See the Alert Level Definitions Section for more information. The annunciation tone may be tested from the AUX - System Status Page.

### Testing the system annunciation tone:

- 1) Use the **FMS** Knob to select the AUX - System Status Page.
- 2) Select the **ANN TEST** Softkey.

Or:

- a) Press the **MENU** Key.
- b) Highlight 'Enable Annunciator Test Mode' and press the **ENT** Key.

LRU INFO	STATUS	SERIAL NUMBER	VERSION	AIRFRAME	PARAMETER	VALUE
COM1	✓		7.00	AIRFRAME		Diamond DA40NG
COM2	✓		7.00	SYS SOFTWARE VERSION		0915.04
GDC1	✓	27000006	2.02d	CONFIGURATION ID		E65908BB
GEA1	✓	47801548	1.05	CRG PART NUMBER		190-00953-XX
GIA1	✓	47801373	1.05	SYSTEM ID		00000000
GIA2	✓	47750372	3.02.00	CHECKLIST		NOT AVAILABLE
GMA1	✓	46701911	2.07	<b>MFD1 DATABASE</b>		
GMU1	✓	46701913	2.07	NAVIGATION - INTERNAL		
GPS1	✓	FFFFFFF-F	1.02	REGION		WORLDWIDE
GPS2	✓	68500319	1.02	CYCLE		1111
GRS1	✓	48400000	3.01	EFFECTIVE		20-OCT-11
GS1	✓	48400001	3.01	EXPIRES		17-NOV-11
GS2	✓		2.02d	Copyright 2011. Jeppesen Sanderson, Inc.		
GTX1	✓	47500593	2.01	<b>BASEMAP - BOTTOM CARD</b>		
MFD1	✓	47500607	2.01	REGION		WORLDWIDE
NAV1	✓	AB0062149	2.3	VERSION		4.00
				GARMIN LTD. AND ITS SUBSIDIARIES 2010		
				<b>SAFETAXI - BOTTOM CARD</b>		
				REGION		US
				VERSION		2.34

Press to Test Annunciation Tone

Figure A-2 Annunciation Tone Testing  
(AUX-System Status Page)

## ALERT LEVEL DEFINITIONS

The G1000 Alerting System, as installed in Diamond DA40NG aircraft, uses three alert levels.

- **WARNING:** This level of alert requires immediate attention.

Warning alert text is shown in red in the Annunciation Window and is accompanied by a continuous chime and a flashing 'WARNING' Softkey annunciation. Pressing the **WARNING** Softkey acknowledges the presence of the warning alert and stops the aural chime.



- **CAUTION:** This level of alert indicates the existence of abnormal conditions on the aircraft that may require intervention.

Caution alert text is shown in yellow in the Annunciation Window and is accompanied by a single chime and a flashing ‘CAUTION’ Softkey annunciation. Pressing the **CAUTION** Softkey acknowledges the presence of the caution alert.

- **ANNUNCIATION OR MESSAGE ADVISORY:** This level of alert provides general information.

Annunciation alert text is shown in white in the Annunciation Window; no aural tone is generated. An annunciation alert is accompanied by a flashing **ADVISORY** Softkey annunciation. Pressing the **ADVISORY** Softkey acknowledges the presence of the annunciation alert.

Message advisory alerts do not issue annunciations in the Annunciation Window. Instead, message advisory alerts only issue a flashing ‘ADVISORY’ Softkey annunciation. Selecting the **ADVISORY** Softkey acknowledges the presence of the message advisory alert and displays the alert text message in the Alerts Window.



Figure A-3 Softkey Annunciation (ALERTS Softkey Labels)

## AIRCRAFT ALERTS

The following alerts are configured specifically for the Diamond DA40NG. Red annunciation window text signifies warnings and yellow, cautions. See the Aircraft Flight Manual (AFM) for recommended pilot actions.

Annunciation Window Text	Alerts Window Message	Audio Alert
<b>OIL PRES</b>	Engine oil pressure is less than 0.9 bar.	Continuous Aural Tone
<b>ENG TEMP</b>	Engine coolant temp is >105 deg. C.	
<b>OIL TEMP</b>	Engine oil temp is greater than 140 deg. C.	
<b>L FUEL TEMP</b>	Left fuel temp is greater than 60 deg. C.	
<b>R FUEL TEMP</b>	Right fuel temp is greater than 60 deg. C.	
<b>GBOX TEMP</b>	Engine gearbox temp is > 120 deg. C.	
<b>ALTN FAIL</b>	Engine alternator has failed.	
<b>ALTN AMPS</b>	Engine alternator output is > 70 amps.	
<b>STARTER</b>	Engine starter is engaged.	
<b>DOOR OPEN</b>	Front or rear door is not closed.	
<b>AP TRIM FAIL*</b>	Autopilot automatic trim is inoperative.	
<b>FUEL PRES</b>	Engine fuel pressure is low.	Single Aural Tone
<b>ECU A FAIL</b>	Engine ECU A has failed.	
<b>ECU B FAIL</b>	Engine ECU B has failed.	
<b>FUEL LOW</b>	Left fuel quantity is low	
<b>VOLTS LOW</b>	Bus voltage is less than 25 volts.	
<b>COOL LVL</b>	Engine coolant level is low.	
<b>PITOT FAIL</b>	Pitot heat has failed.	
<b>PITOT HT OFF</b>	Pitot heat is off.	

\* KAP 140 installations only.

Annunciation Window Text	Alerts Window Message	Audio Alert
<b>GLOW ON FUEL XFER</b>	Engine glow plug active.	None
	Fuel transfer in progress	
None	<b>PFD FAN FAIL</b> – The cooling fan for the PFD is inoperative.	None
	<b>MFD FAN FAIL</b> – The cooling fan for the MFD is inoperative.	
	<b>GIA FAN FAIL</b> – The cooling fan for the GIAs is inoperative.	

## VOICE ALERTS

The following audio alerts are announced by the system using a voice of male or female gender.

Voice Alert	Alert Trigger
"Minimums, Minimums"	Issued when the aircraft transitions through the minimum descent altitude/decision height (MDA/DH)
"Vertical Track"	Aircraft is one minute from Top of Descent - issued only when vertical navigation is enabled
"Traffic"	TIS voice alert - issued when a Traffic Advisory (TA) is issued
"Traffic Not Available"	TIS voice alert - issued when the TIS traffic system fails or cannot communicate
"Traffic, Traffic"	TAS voice alert - issued when a Traffic Advisory (TA) is issued
"Traffic Advisory System Test Passed"	TAS voice alert - issued when the TAS passes a pilot-initiated self test
"Traffic Advisory System Test Failed"	TAS voice alert - issued when the TAS fails a pilot-initiated self test

### Selecting the audio alert voice:

- 1) Use the **FMS** Knob to select the AUX - System Setup Page.
- 2) Press the **FMS** Knob to activate the cursor.
- 3) Turn the large **FMS** Knob to highlight the voice in the Audio Alert Box.
- 4) Turn the small **FMS** Knob to select the desired voice, press the ENT Key.

**G1000 SYSTEM ANNUNCIATIONS**

**NOTE:** Upon power-up, certain windows remain invalid as G1000 equipment begins to initialize. All windows should be operational within one minute of power-up. If any window continues to remain flagged, the G1000 System should be serviced by a Garmin-authorized repair facility.

When an LRU or an LRU function fails, a large red 'X' is typically displayed on windows associated with the failed data (refer to Figure B-1 for all possible flags and the responsible LRUs). Refer to the Aircraft Flight Manual (AFM) for additional information regarding pilot responses to these annunciations.

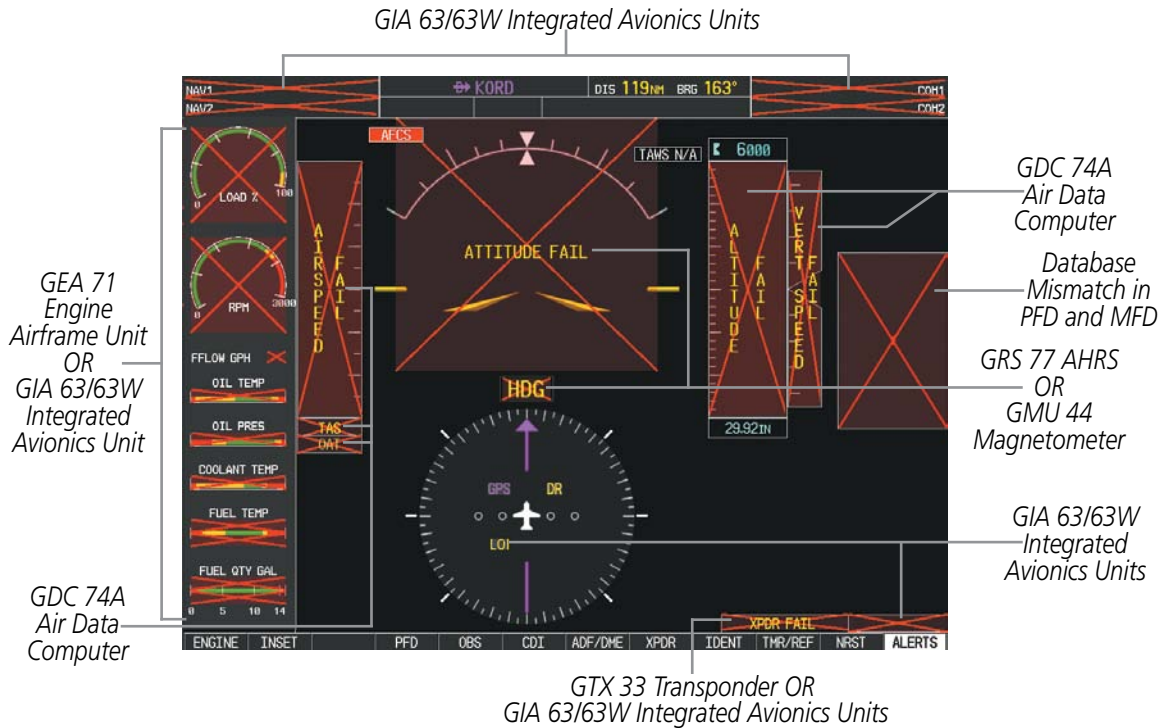





**Figure A-4 G1000 System Failure Annunciations**





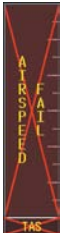

The status of detected LRUs can be checked on the AUX - System Status Page (Figure A-2). Active LRUs are indicated by green check marks; failed, by red 'X's. Failed LRUs should be noted and a service center or Garmin-authorized dealer informed.

**Viewing LRU information:**

- 1) Use the **FMS** Knob to select the AUX - System Status Page.
- 2) To place the cursor in the 'LRU Info' Box,
  - a) Select the **LRU** Softkey.
  - Or:
    - a) Press the **MENU** Key.
    - b) With 'Select LRU Window' highlighted, press the **ENT** Key.
- 3) Use the **FMS** Knob to scroll through the box to view LRU status information.

SYSTEM OVERVIEW  
 FLIGHT INSTRUMENTS  
 EIS  
 AUDIO PANEL & CNS  
 FLIGHT MANAGEMENT  
 HAZARD AVOIDANCE  
 AFCS  
 ADDITIONAL FEATURES  
 APPENDICES  
 INDEX

System Annunciation	Comment
	Attitude and Heading Reference System is aligning.
	Display system is not receiving attitude information from the AHRS.
	AHRS calibration incomplete or configuration module failure.
	This annunciation is seen only when the autopilot is engaged. The annunciation indicates an AHRS monitor has detected an abnormal flight parameter, possibly caused by strong turbulence. In this case, the situation should correct itself within a few seconds. If there is an actual failure, a red "X" soon appears over the Attitude Indicator.
	GPS information is either not present or is invalid for navigation use. Note that AHRS utilizes GPS inputs during normal operation. AHRS operation may be degraded if GPS signals are not present (see AFM).
	Display system is not receiving airspeed input from air data computer.

System Annunciation	Comment
	Display system is not receiving vertical speed input from the air data computer.
	Display system is not receiving valid heading input from AHRS.
	Display system is not receiving altitude input from the air data computer.
	Display system is not receiving valid true airspeed information from air data computer.
	Display system is not receiving valid OAT information from air data computer.
	Display system is not receiving valid transponder information.
	Different versions of GDU software are installed in the PFD and MFD. This can also indicate different versions of the navigation database installed in the PFD and MFD. In some circumstances, a cross-talk error between the PFD and MFD can cause this annunciation.
Other Various Red X Indications	A red 'X' through any other display field (such as engine instrumentation fields) indicates that the field is not receiving valid data.

## G1000 SYSTEM MESSAGE ADVISORIES



**NOTE:** This section provides information regarding G1000 message advisories that may be displayed by the system. Knowledge of the aircraft, systems, flight conditions, and other existing operational priorities must be considered when responding to a message.

This section describes various G1000 System message advisories. Certain messages are issued due to an LRU or LRU function failure. Such messages are normally accompanied by a corresponding red 'X' annunciation as shown previously in the G1000 System Annunciations section.

### PRIMARY FLIGHT DISPLAY & MULTI FUNCTION DISPLAY

Message Advisory	Comments
<b>DATA LOST</b> – Pilot stored data was lost. Recheck settings.	The pilot profile data was lost. System reverts to default pilot profile and settings. The pilot may reconfigure the MFD & PFD with preferred settings, if desired.
<b>XTALK ERROR</b> – A flight display crosstalk error has occurred.	The MFD and PFD are not communicating with each other. The G1000 system should be serviced.
<b>PFD1 SERVICE</b> – PFD1 needs service. Return unit for repair.	The PFD and/or MFD self-test has detected a problem. The G1000 system should be serviced.
<b>MFD1 SERVICE</b> – MFD1 needs service. Return unit for repair.	
<b>MANIFEST</b> – PFD1 software mismatch, communication halted.	The PFD and/or MFD has incorrect software installed. The G1000 system should be serviced.
<b>MANIFEST</b> – MFD1 software mismatch, communication halted.	
<b>PFD1 CONFIG</b> – PFD1 config error. Config service req'd.	The PFD configuration settings do not match backup configuration memory. The G1000 system should be serviced.
<b>MFD1 CONFIG</b> – MFD1 config error. Config service req'd.	The MFD configuration settings do not match backup configuration memory. The G1000 system should be serviced.
<b>SW MISMATCH</b> – GDU software version mismatch. Xtalk is off.	The MFD and PFD have different software versions installed. The G1000 system should be serviced.
<b>PFD1 COOLING</b> – PFD1 has poor cooling. Reducing power usage.	The PFD and/or MFD is overheating and is reducing power consumption by dimming the display. If problem persists, the G1000 system should be serviced.
<b>MFD1 COOLING</b> – MFD1 has poor cooling. Reducing power usage.	
<b>PFD1 KEYSTK</b> – PFD1 [key name] is stuck.	A key is stuck on the PFD and/or MFD bezel. Attempt to free the stuck key by pressing it several times. The G1000 system should be serviced if the problem persists.
<b>MFD1 KEYSTK</b> – MFD1 [key name] is stuck.	
<b>CNFG MODULE</b> – PFD1 configuration module is inoperative.	The PFD1 configuration module backup memory has failed. The G1000 system should be serviced.
<b>PFD1 VOLTAGE</b> – PFD1 has low voltage. Reducing power usage	The PFD1 voltage is low. The G1000 system should be serviced.
<b>MFD1 VOLTAGE</b> – MFD1 has low voltage. Reducing power usage	The MFD voltage is low. The G1000 system should be serviced.

DATABASES

Message Advisory	Comments
<b>MFD1 DB ERR</b> – MFD1 navigation database error exists.	The MFD and/or PFD detected a failure in the aviation database. Attempt to reload the aviation database. If problem persists, the G1000 system should be serviced.
<b>PFD1 DB ERR</b> – PFD1 navigation database error exists.	
<b>MFD1 DB ERR</b> – MFD1 basemap database error exists.	The MFD and/or PFD detected a failure in the basemap database.
<b>PFD1 DB ERR</b> – PFD1 basemap database error exists.	
<b>MFD1 DB ERR</b> – MFD1 terrain database error exists.	The MFD and/or PFD detected a failure in the terrain database. Ensure that the terrain card is properly inserted in display. Replace terrain card. If problem persists, The G1000 system should be serviced.
<b>PFD1 DB ERR</b> – PFD1 terrain database error exists.	
<b>MFD1 DB ERR</b> – MFD1 terrain database missing.	The terrain database is present on another LRU, but is missing on the specified LRU.
<b>PFD1 DB ERR</b> – PFD1 terrain database missing.	
<b>MFD1 DB ERR</b> – MFD1 obstacle database error exists.	The MFD and/or PFD detected a failure in the obstacle database. Ensure that the data card is properly inserted. Replace data card. If problem persists, The G1000 system should be serviced.
<b>PFD1 DB ERR</b> – PFD1 obstacle database error exists.	
<b>MFD1 DB ERR</b> – MFD1 obstacle database missing.	The obstacle database is present on another LRU, but is missing on the specified LRU.
<b>PFD1 DB ERR</b> – PFD1 obstacle database missing.	
<b>MFD1 DB ERR</b> – MFD1 airport terrain database error exists.	The MFD and/or PFD detected a failure in the airport terrain database. Ensure that the data card is properly inserted. Replace data card. If problem persists, The G1000 system should be serviced.
<b>PFD1 DB ERR</b> – PFD1 airport terrain database error exists.	
<b>MFD1 DB ERR</b> – MFD1 airport terrain database missing.	The airport terrain database is present on another LRU, but is missing on the specified LRU.
<b>PFD1 DB ERR</b> – PFD1 airport terrain database missing.	
<b>MFD1 DB ERR</b> – MFD1 Safe Taxi database error exists.	The MFD and/or PFD detected a failure in the Safe Taxi database. Ensure that the data card is properly inserted. Replace data card. If problem persists, The G1000 system should be serviced.
<b>PFD1 DB ERR</b> – PFD1 Safe Taxi database error exists.	
<b>MFD1 DB ERR</b> – MFD1 Chartview database error exists.	The MFD and/or PFD detected a failure in the ChartView database (optional feature). Ensure that the data card is properly inserted. Replace data card. If problem persists, The G1000 system should be serviced.
<b>MFD1 DB ERR</b> – MFD1 FliteCharts database error exists.	The MFD and/or PFD detected a failure in the FliteCharts database (optional feature). Ensure that the data card is properly inserted. Replace data card. If problem persists, The G1000 system should be serviced.

SYSTEM OVERVIEW

FLIGHT INSTRUMENTS

EIS

AUDIO PANEL & CNS

FLIGHT MANAGEMENT

HAZARD AVOIDANCE

AFCS

ADDITIONAL FEATURES

APPENDICES

INDEX



**DATABASES (CONT.)**

<b>Message Advisory</b>	<b>Comments</b>
<b>MFD1 DB ERR</b> – MFD1 Airport Directory database error exists.	The MFD detected a failure in the Airport Directory database. Ensure that the data card is properly inserted. Replace data card. If problem persists, the system should be serviced.
<b>MFD1 DB ERR</b> – MFD1 multiple database errors exists.	The MFD and/or PFD detected a failure in more than one database. If problem persists, the system should be serviced.
<b>PFD1 DB ERR</b> multiple database errors exists.	
<b>DB MISMATCH</b> – Navigation database mismatch. Xtalk is off.	The PFD and MFD have different navigation database versions or types installed. Crossfill is off. Check the AUX-SYSTEM STATUS Page to determine versions or regions. Also, check the AUX-SYSTEM STATUS Page for a database synchronization function not completed. After synchronization is complete, power must be turned off, then on.
<b>DB MISMATCH</b> – Standby Navigation database mismatch.	The PFD and MFD have different standby navigation database versions or types installed. Check the AUX-SYSTEM STATUS Page to determine versions or regions. Also, check the AUX-SYSTEM STATUS Page for a database synchronization function not completed. After synchronization is complete, power must be turned off, then on.
<b>DB MISMATCH</b> – Terrain database mismatch.	The PFD and MFD have different terrain database versions or types installed. Check the AUX-SYSTEM STATUS Page to determine versions or regions. Also, check the AUX-SYSTEM STATUS Page for a database synchronization function not completed. After synchronization is complete, power must be turned off, then on.
<b>DB MISMATCH</b> – Obstacle database mismatch.	The PFD and MFD have different obstacle database versions or types installed. Check the AUX-SYSTEM STATUS Page to determine versions or regions. Also, check the AUX-SYSTEM STATUS Page for a database synchronization function not completed. After synchronization is complete, power must be turned off, then on.
<b>DB MISMATCH</b> – Airport Terrain database mismatch.	The PFD and MFD have different airport terrain database versions or types installed. Check the AUX-SYSTEM STATUS Page to determine versions or regions. Also, check the AUX-SYSTEM STATUS Page for a database synchronization function not completed. After synchronization is complete, power must be turned off, then on.
<b>TERRAIN DSP</b> – [PFD1 or MFD1] Terrain awareness display unavailable.	One of the terrain, airport terrain, or obstacle databases required for Terrain-SVS in the specified PFD or MFD is missing or invalid.



## GMA 1347 AUDIO PANEL

Message Advisory	Comments
<b>GMA1 FAIL</b> – GMA1 is inoperative.	The audio panel self-test has detected a failure. The audio panel is unavailable. The G1000 system should be serviced.
<b>GMA1 CONFIG</b> – GMA1 config error. Config service req'd.	The audio panel configuration settings do not match backup configuration memory. The G1000 system should be serviced.
<b>MANIFEST</b> – GMA1 software mismatch, communication halted.	The audio panel has incorrect software installed. The G1000 system should be serviced.
<b>GMA1 SERVICE</b> – GMA1 needs service. Return unit for repair.	The audio panel self-test has detected a problem in the unit. Certain audio functions may still be available, and the audio panel may still be usable. The G1000 system should be serviced when possible.

## GEA 71 ENGINE/AIRFRAME UNIT

Message Advisory	Comments
<b>GEA1 CONFIG</b> – GEA1 config error. Config service req'd.	The GEA1 configuration settings do not match those of backup configuration memory. The G1000 system should be serviced.
<b>MANIFEST</b> – GEA1 software mismatch, communication halted.	The #1 GEA 71 has incorrect software installed. The G1000 system should be serviced.

## GMU 44 MAGNETOMETER

Message Advisory	Comments
<b>HDG FAULT</b> – AHRS1 magnetometer fault has occurred.	A fault has occurred in the #1 GMU 44. Heading is flagged as invalid. The AHRS uses GPS for backup mode operation. The G1000 system should be serviced.
<b>MANIFEST</b> – GMU1 software mismatch, communication halted.	The GMU 44 has incorrect software installed. The G1000 system should be serviced.

**GIA 63 INTEGRATED AVIONICS UNIT**

Message	Comments
<b>GIA1 CONFIG</b> – GIA1 config error. Config service req'd.	The GIA1 and/or GIA2 configuration settings do not match backup configuration memory. The G1000 system should be serviced.
<b>GIA2 CONFIG</b> – GIA2 config error. Config service req'd.	
<b>GIA1 CONFIG</b> – GIA1 audio config error. Config service req'd.	The GIA1 and/or GIA2 have an error in the audio configuration. The G1000 system should be serviced.
<b>GIA2 CONFIG</b> – GIA2 audio config error. Config service req'd.	
<b>GIA1 COOLING</b> – GIA1 temperature too low.	The GIA1 and/or GIA2 temperature is too low to operate correctly. Allow units to warm up to operating temperature.
<b>GIA2 COOLING</b> – GIA2 temperature too low.	
<b>GIA1 COOLING</b> – GIA1 over temperature.	The GIA1 and/or GIA2 temperature is too high. If problem persists, the G1000 system should be serviced.
<b>GIA2 COOLING</b> – GIA2 over temperature.	
<b>GIA1 SERVICE</b> – GIA1 needs service. Return the unit for repair.	The GIA1 and/or GIA2 self-test has detected a problem in the unit. The G1000 system should be serviced.
<b>GIA2 SERVICE</b> – GIA2 needs service. Return the unit for repair.	
<b>MANIFEST</b> – GIA1 software mismatch, communication halted.	The GIA1 and/or GIA 2 has incorrect software installed. The G1000 system should be serviced.
<b>MANIFEST</b> – GIA2 software mismatch, communication halted.	
<b>COM1 TEMP</b> – COM1 over temp. Reducing transmitter power.	The system has detected an over temperature condition in COM1 and/or COM2. The transmitter will operate at reduced power. If the problem persists, the G1000 system should be serviced.
<b>COM2 TEMP</b> – COM2 over temp. Reducing transmitter power.	
<b>COM1 SERVICE</b> – COM1 needs service. Return unit for repair.	The system has detected a failure in COM1 and/or COM2. COM1 and/or COM2 may still be usable. The G1000 system should be serviced when possible.
<b>COM2 SERVICE</b> – COM2 needs service. Return unit for repair.	
<b>COM1 PTT</b> – COM1 push-to-talk key is stuck.	The COM1 and/or COM2 external push-to-talk switch is stuck in the enable (or “pressed”) position. Press the PTT switch again to cycle its operation. If the problem persists, the G1000 system should be serviced.
<b>COM2 PTT</b> – COM2 push-to-talk key is stuck.	
<b>COM1 RMT XFR</b> – COM1 remote transfer key is stuck.	The COM1 and/or COM2 transfer switch is stuck in the enabled (or “pressed”) position. Press the transfer switch again to cycle its operation. If the problem persists, the G1000 system should be serviced.
<b>COM2 RMT XFR</b> – COM2 remote transfer key is stuck.	

## GIA 63 (CONT.)

Message	Comments
<b>RAIM UNAVAIL</b> – RAIM is not available from FAF to MAP waypoints.	GPS satellite coverage is insufficient to perform Receiver Autonomous Integrity Monitoring (RAIM) from the FAF to the MAP waypoints.
<b>LOI</b> – GPS integrity lost. Crosscheck with other NAVS.	Loss of GPS integrity monitoring.
<b>GPS NAV LOST</b> – Loss of GPS navigation. Insufficient satellites.	Loss of GPS navigation due to insufficient satellites.
<b>GPS NAV LOST</b> – Loss of GPS navigation. Position error.	Loss of GPS navigation due to position error.
<b>GPS NAV LOST</b> – Loss of GPS navigation. GPS fail.	Loss of GPS navigation due to GPS failure.
<b>ABORT APR</b> – Loss of GPS navigation. Abort approach.	Abort approach due to loss of GPS navigation.
<b>TRUE APR</b> – True north approach. Change HDG reference to TRUE.	Displayed after passing the first waypoint of a true north approach when the nav angle is set to 'AUTO'.
<b>GPS1 FAIL</b> – GPS1 is inoperative.	A failure has been detected in the GPS1 and/or GPS2 receiver. The receiver is unavailable. The G1000 system should be serviced.
<b>GPS2 FAIL</b> – GPS2 is inoperative.	
<b>GPS1 SERVICE</b> – GPS1 needs service. Return unit for repair.	A failure has been detected in the GPS1 and/or GPS2 receiver. The receiver may still be available. The G1000 system should be serviced.
<b>GPS2 SERVICE</b> – GPS2 needs service. Return unit for repair.	
<b>NAV1 SERVICE</b> – NAV1 needs service. Return unit for repair.	A failure has been detected in the NAV1 and/or NAV2 receiver. The receiver may still be available. The G1000 system should be serviced.
<b>NAV2 SERVICE</b> – NAV2 needs service. Return unit for repair.	
<b>NAV1 RMT XFR</b> – NAV1 remote transfer key is stuck.	The remote NAV1 and/or NAV2 transfer switch is stuck in the enabled (or “pressed”) state. Press the transfer switch again to cycle its operation. If the problem persists, the G1000 system should be serviced.
<b>NAV2 RMT XFR</b> – NAV2 remote transfer key is stuck.	
<b>G/S1 FAIL</b> – G/S1 is inoperative.	A failure has been detected in glideslope receiver 1 and/or receiver 2. The G1000 system should be serviced.
<b>G/S2 FAIL</b> – G/S2 is inoperative.	
<b>G/S1 SERVICE</b> – G/S1 needs service. Return unit for repair.	A failure has been detected in glideslope receiver 1 and/or receiver 2. The receiver may still be available. The G1000 system should be serviced when possible.
<b>G/S2 SERVICE</b> – G/S2 needs service. Return unit for repair.	

**GIA 63W INTEGRATED AVIONICS UNIT**

Message Advisory	Comments
<b>GIA1 CONFIG</b> – GIA1 config error. Config service req'd.	The GIA1 and/or GIA2 configuration settings do not match backup configuration memory. The G1000 system should be serviced.
<b>GIA2 CONFIG</b> – GIA2 config error. Config service req'd.	
<b>GIA1 CONFIG</b> – GIA1 audio config error. Config service req'd.	The GIA1 and/or GIA2 have an error in the audio configuration. The G1000 system should be serviced.
<b>GIA2 CONFIG</b> – GIA2 audio config error. Config service req'd.	
<b>GIA1 COOLING</b> – GIA1 temperature too low.	The GIA1 and/or GIA2 temperature is too low to operate correctly. Allow units to warm up to operating temperature.
<b>GIA2 COOLING</b> – GIA2 temperature too low.	
<b>GIA1 COOLING</b> – GIA1 over temperature.	The GIA1 and/or GIA2 temperature is too high. If problem persists, the G1000 system should be serviced.
<b>GIA2 COOLING</b> – GIA2 over temperature.	
<b>GIA1 SERVICE</b> – GIA1 needs service. Return the unit for repair.	The GIA1 and/or GIA2 self-test has detected a problem in the unit. The G1000 system should be serviced.
<b>GIA2 SERVICE</b> – GIA2 needs service. Return the unit for repair.	
<b>HW MISMATCH</b> – GIA hardware mismatch. GIA1 communication halted.	A GIA mismatch has been detected, where only one is WAAS capable.
<b>HW MISMATCH</b> – GIA hardware mismatch. GIA2 communication halted.	
<b>MANIFEST</b> – GIA1 software mismatch, communication halted.	The GIA1 and/or GIA 2 has incorrect software installed. The G1000 system should be serviced.
<b>MANIFEST</b> – GIA2 software mismatch, communication halted.	
<b>COM1 TEMP</b> – COM1 over temp. Reducing transmitter power.	The system has detected an over temperature condition in COM1 and/or COM2. The transmitter operates at reduced power. If the problem persists, the G1000 system should be serviced.
<b>COM2 TEMP</b> – COM2 over temp. Reducing transmitter power.	
<b>COM1 SERVICE</b> – COM1 needs service. Return unit for repair.	The system has detected a failure in COM1 and/or COM2. COM1 and/or COM2 may still be usable. The G1000 system should be serviced when possible.
<b>COM2 SERVICE</b> – COM2 needs service. Return unit for repair.	
<b>COM1 PTT</b> – COM1 push-to-talk key is stuck.	The COM1 and/or COM2 external push-to-talk switch is stuck in the enable (or "pressed") position. Press the PTT switch again to cycle its operation. If the problem persists, the G1000 system should be serviced.
<b>COM2 PTT</b> – COM2 push-to-talk key is stuck.	

**GIA 63W (CONT.)**

Message Advisory	Comments
<b>COM1 RMT XFR</b> – COM1 remote transfer key is stuck.	The COM1 and/or COM2 transfer switch is stuck in the enabled (or “pressed”) position. Press the transfer switch again to cycle its operation. If the problem persists, the G1000 system should be serviced.
<b>COM2 RMT XFR</b> – COM2 remote transfer key is stuck.	
<b>LOI</b> – GPS integrity lost. Crosscheck with other NAVS.	GPS integrity is insufficient for the current phase of flight.
<b>GPS NAV LOST</b> – Loss of GPS navigation. Insufficient satellites.	Loss of GPS navigation due to insufficient satellites.
<b>GPS NAV LOST</b> – Loss of GPS navigation. Position error.	Loss of GPS navigation due to position error.
<b>GPS NAV LOST</b> – Loss of GPS navigation. GPS fail.	Loss of GPS navigation due to GPS failure.
<b>ABORT APR</b> – Loss of GPS navigation. Abort approach.	Abort approach due to loss of GPS navigation.
<b>APR DWNGRADE</b> – Approach downgraded.	Use LNAV minima when approach is downgraded.
<b>TRUE APR</b> – True north approach. Change HDG reference to TRUE.	Displayed after passing the first waypoint of a true north approach when the nav angle is set to ‘MAGNETIC’.
<b>GPS1 SERVICE</b> – GPS1 needs service. Return unit for repair.	A failure has been detected in the GPS1 and/or GPS2 receiver. The receiver may still be available. The G1000 system should be serviced.
<b>GPS2 SERVICE</b> – GPS2 needs service. Return unit for repair.	
<b>NAV1 SERVICE</b> – NAV1 needs service. Return unit for repair.	A failure has been detected in the NAV1 and/or NAV2 receiver. The receiver may still be available. The G1000 system should be serviced.
<b>NAV2 SERVICE</b> – NAV2 needs service. Return unit for repair.	
<b>NAV1 RMT XFR</b> – NAV1 remote transfer key is stuck.	The remote NAV1 and/or NAV2 transfer switch is stuck in the enabled (or “pressed”) state. Press the transfer switch again to cycle its operation. If the problem persists, the G1000 system should be serviced.
<b>NAV2 RMT XFR</b> – NAV2 remote transfer key is stuck.	
<b>G/S1 FAIL</b> – G/S1 is inoperative.	A failure has been detected in glideslope receiver 1 and/or receiver 2. The G1000 system should be serviced.
<b>G/S2 FAIL</b> – G/S2 is inoperative.	
<b>G/S1 SERVICE</b> – G/S1 needs service. Return unit for repair.	A failure has been detected in glideslope receiver 1 and/or receiver 2. The receiver may still be available. The G1000 system should be serviced when possible.
<b>G/S2 SERVICE</b> – G/S2 needs service. Return unit for repair.	

SYSTEM OVERVIEW

FLIGHT INSTRUMENTS

EIS

AUDIO PANEL & CNS

FLIGHT MANAGEMENT

HAZARD AVOIDANCE

AFCS

ADDITIONAL FEATURES

APPENDICES

INDEX

**GTX 33 TRANSPONDER**

Message Advisory	Comments
<b>XPDR1 CONFIG</b> – XPDR1 config error. Config service req'd.	The transponder configuration settings do not match those of backup configuration memory. The G1000 system should be serviced.
<b>MANIFEST</b> – GTX1 software mismatch, communication halted.	The transponder has incorrect software installed. The G1000 system should be serviced.
<b>XPDR1 SRVC</b> – XPDR1 needs service. Return unit for repair.	The #1 transponder should be serviced when possible.
<b>XPDR1 FAIL</b> – XPDR1 is inoperative.	There is no communication with the #1 transponder.

**GRS 77 ATTITUDE AND HEADING REFERENCE SYSTEM**

Message Advisory	Comments
<b>AHRS1 TAS</b> – AHRS1 not receiving valid airspeed.	The #1 AHRS is not receiving true airspeed from the air data computer. The AHRS relies on GPS information to augment the lack of airspeed. The G1000 system should be serviced.
<b>AHRS1 GPS</b> – AHRS1 using backup GPS source.	The #1 AHRS is using the backup GPS path. Primary GPS path has failed. The G1000 system should be serviced when possible.
<b>AHRS1 GPS</b> – AHRS1 not receiving any GPS information.	The #1 AHRS is not receiving any or any useful GPS information. Check AFM limitations. The G1000 system should be serviced.
<b>AHRS1 GPS</b> – AHRS1 not receiving backup GPS information.	The #1 AHRS is not receiving backup GPS information. The G1000 system should be serviced.
<b>AHRS1 GPS</b> – AHRS1 operating exclusively in no-GPS mode.	The #1 AHRS is operating exclusively in no-GPS mode. The G1000 system should be serviced.
<b>AHRS1 SRVC</b> – AHRS1 Magnetic-field model needs update.	The #1 AHRS earth magnetic field model is out of date. Update magnetic field model when practical.
<b>GEO LIMITS</b> – AHRS1 too far North/South, no magnetic compass.	The aircraft is outside geographical limits for approved AHRS operation. Heading is flagged as invalid.
<b>MANIFEST</b> – GRS1 software mismatch, communication halted.	The #1 AHRS has incorrect software installed. The G1000 system should be serviced.

**GDL 69/69A SATELLITE DATALINK RECEIVER**

Message Advisory	Comments
<b>GDL69 CONFIG</b> – GDL 69 config error. Config service req'd.	GDL 69 configuration settings do not match those of backup configuration memory. The G1000 system should be serviced.
<b>GDL69 FAIL</b> – GDL 69 has failed.	A failure has been detected in the GDL 69. The receiver is unavailable. The G1000 system should be serviced.
<b>MANIFEST</b> – GDL software mismatch, communication halted.	The GDL 69 has incorrect software installed. The G1000 system should be serviced.

**GDC 74A AIR DATA COMPUTER**

Message Advisory	Comments
<b>MANIFEST</b> – GDC1 software mismatch, communication halted.	The GDC 74A has incorrect software installed. The G1000 system should be serviced.

## MISCELLANEOUS

Message Advisory	Comments
<b>FPL WPT LOCK</b> – Flight plan waypoint is locked.	Upon power-up, the G1000 system detects that a stored flight plan waypoint is locked. This occurs when an aviation database update eliminates an obsolete waypoint. The flight plan cannot find the specified waypoint and flags this message. This can also occur with user waypoints in a flight plan that is deleted. Remove the waypoint from the flight plan if it no longer exists in any database, OR update the waypoint name/identifier to reflect the new information.
<b>FPL WPT MOVE</b> – Flight plan waypoint moved.	The system has detected that a waypoint coordinate has changed due to a new aviation database update. Verify that stored flight plans contain correct waypoint locations.
<b>TIMER EXPIRD</b> – Timer has expired.	The system notifies the pilot that the timer has expired.
<b>DB CHANGE</b> – Database changed. Verify user modified procedures.	This occurs when a stored flight plan contains procedures that have been manually edited. This alert is issued only after an aviation database update. Verify that the user-modified procedures in stored flight plans are correct and up to date.
<b>DB CHANGE</b> – Database changed. Verify stored airways.	This occurs when a stored flight plan contains an airway that is no longer consistent with the aviation database. This alert is issued only after an aviation database update. Verify use of airways in stored flight plans and reload airways as needed.
<b>FPL TRUNC</b> – Flight plan has been truncated.	This occurs when a newly installed navigation database eliminates an obsolete approach or arrival used by a stored flight plan. The obsolete procedure is removed from the flight plan. Update flight plan with current arrival or approach.
<b>LOCKED FPL</b> – Cannot navigate locked flight plan.	This occurs when the pilot attempts to activate a stored flight plan that contains locked waypoint. Remove locked waypoint from flight plan. Update flight plan with current waypoint.
<b>WPT ARRIVAL</b> – Arriving at waypoint -[xxxx]	Arriving at waypoint [xxxx], where [xxxx] is the waypoint name.
<b>STEEP TURN</b> – Steep turn ahead.	A steep turn is 15 seconds ahead. Prepare to turn.
<b>INSIDE ARSPC</b> – Inside airspace.	The aircraft is inside the airspace.
<b>ARSPC AHEAD</b> – Airspace ahead less than 10 minutes.	Special use airspace is ahead of aircraft. The aircraft will penetrate the airspace within 10 minutes.
<b>ARSPC NEAR</b> – Airspace near and ahead.	Special use airspace is near and ahead of the aircraft position.
<b>ARSPC NEAR</b> – Airspace near – less than 2 nm.	Special use airspace is within 2 nm of the aircraft position.
<b>APR INACTV</b> – Approach is not active.	The system notifies the pilot that the loaded approach is not active. Activate approach when required.
<b>[PFD1 or MFD1] CARD 1 REM</b> – Card 1 was removed. Reinsert card.	The SD card was removed from the top card slot of the specified PFD or MFD. The SD card needs to be reinserted.
<b>[PFD1 or MFD1] CARD 2 REM</b> – Card 2 was removed. Reinsert card.	The SD card was removed from the bottom card slot of the specified PFD or MFD. The SD card needs to be reinserted.
<b>[PFD1 or MFD1] CARD 1 ERR</b> – Card 1 is invalid.	The SD card in the top card slot of the specified PFD or MFD contains invalid data.
<b>[PFD1 or MFD1] CARD 2 ERR</b> – Card 2 is invalid.	The SD card in the bottom card slot of the specified PFD or MFD contains invalid data.



**MISCELLANEOUS (CONT.)**

Message Advisory	Comments
<b>SLCT FREQ</b> – Select appropriate frequency for approach.	The system notifies the pilot to load the approach frequency for the appropriate NAV receiver. Select the correct frequency for the approach.
<b>SLCT NAV</b> – Select NAV on CDI for approach.	The system notifies the pilot to set the CDI to the correct NAV receiver. Set the CDI to the correct NAV receiver.
<b>PTK FAIL</b> – Parallel track unavailable: bad geometry.	Bad parallel track geometry.
<b>PTK FAIL</b> – Parallel track unavailable: invalid leg type.	Invalid leg type for parallel offset.
<b>PTK FAIL</b> – Parallel track unavailable: past IAF.	IAF waypoint for parallel offset has been passed.
<b>UNABLE V WPT</b> – Can't reach current vertical waypoint.	The current vertical waypoint can not be reached within the maximum flight path angle and vertical speed constraints. The system automatically transitions to the next vertical waypoint.
<b>VNV</b> – Unavailable. Unsupported leg type in flight plan.	The lateral flight plan contains a procedure turn, vector, or other unsupported leg type prior to the active vertical waypoint. This prevents vertical guidance to the active vertical waypoint.
<b>VNV</b> – Unavailable. Excessive crosstrack error.	The current crosstrack exceeds the limit, causing vertical deviation to go invalid.
<b>VNV</b> – Unavailable. Excessive track angle error.	The current track angle error exceeds the limit, causing the vertical deviation to go invalid.
<b>VNV</b> – Unavailable. Parallel course selected.	A parallel course has been selected, causing the vertical deviation to go invalid.
<b>NON WGS84 WPT</b> – Do not use GPS navigation to [xxxx]	The position of the selected waypoint [xxxx] is not calculated based on the WGS84 map reference datum and may be positioned in error as displayed. Do not use GPS to navigate to the selected non-WGS84 waypoint.
<b>TRAFFIC FAIL</b> – Traffic device has failed.	The G1000 is no longer receiving data from the traffic system. The traffic device should be serviced.
<b>STRMSCP FAIL</b> – Stormscope has failed.	Stormscope has failed. The G1000 System should be serviced.
<b>FAILED PATH</b> – A data path has failed.	A data path connected to the GDU or the GIA 63/63W has failed.
<b>MAG VAR WARN</b> – Large magnetic variance. Verify all course angles.	The GDU's internal model cannot determine the exact magnetic variance for geographic locations near the magnetic poles. Displayed magnetic course angles may differ from the actual magnetic heading by more than 2°.
<b>SCHEDULER [#]</b> – <message>.	Message criteria entered by the user.
<b>SVS</b> – SVS DISABLED: Out of available terrain region.	Synthetic Vision is disabled because the aircraft is not within the boundaries of the installed terrain database.
<b>SVS</b> – SVS DISABLED: Terrain DB resolution too low.	Synthetic Vision is disabled because a terrain database of sufficient resolution (9 arc-second or better) is not currently installed.
<b>CHECK CRS</b> – Database course for LOC1 / [LOC ID] is [CRS]°.	Selected course for LOC1 differs from published localizer course by more than 10 degrees.
<b>CHECK CRS</b> – Database course for LOC2 / [LOC ID] is [CRS]°.	Selected course for LOC2 differs from published localizer course by more than 10 degrees.

## AFCS STATUS ANNUNCIATIONS

The following annunciations (listed in order of increasing priority) can appear on the PFD above the Airspeed and Attitude indicators. Only one annunciation may occur at a time, and messages are prioritized by criticality.

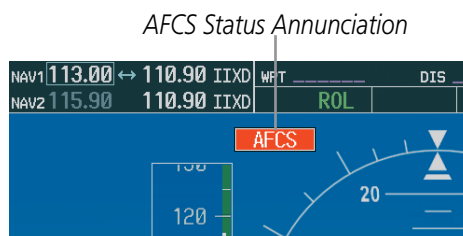

Figure A-5 AFCS Status Annunciation

Alert Condition	Annunciation	Description
Aileron Mistrim Right	<b>AIL→</b>	Roll servo providing sustained force in indicated direction
Aileron Mistrim Left	<b>←AIL</b>	
Elevator Mistrim Down	<b>↓ELE</b>	Pitch servo providing sustained force in the indicated direction
Elevator Mistrim Up	<b>↑ELE</b>	
Pitch Trim Failure (or Stuck <b>AP TRIM</b> Switch)	<b>PTRM</b>	If AP engaged, take control of the aircraft and disengage AP If AP disengaged, move <b>AP TRIM</b> switches separately to unstick
Roll Failure	<b>ROLL</b>	Roll axis control failure; AP inoperative
Pitch Failure	<b>PTCH</b>	Pitch axis control failure; AP inoperative
System Failure	<b>AFCS</b>	AP and MET are unavailable; FD may still be available
Preflight Test	<b>PFT</b>	Performing preflight system test; aural alert sounds at completion Do not press the <b>AP DISC</b> Switch during servo power-up and preflight system tests. Doing so may cause the preflight system test to fail or never to start. Cycle power to the servos if this occurs.
	<b>PFT</b>	Preflight system test failed; aural alert sounds at failure

**TERRAIN-SVS ALERTS**

Annunciations appear on the PFD and MFD. Pop-up alerts appear only on the MFD. For more information on TERRAIN-SVS, refer to the Hazard Avoidance Section.

Alert Type	PFD/MFD TERRAIN-SVS Page Annunciation	Pop-Up Alert (MFD Navigation Map Page)	Aural Message
Reduced Required Terrain Clearance Warning (RTC)	<b>TERRAIN</b>	WARNING TERRAIN	"Warning; Terrain, Terrain"
Imminent Terrain Impact Warning (ITI)	<b>TERRAIN</b>	WARNING TERRAIN	"Warning; Terrain, Terrain"
Reduced Required Obstacle Clearance Warning (ROC)	<b>TERRAIN</b>	WARNING OBSTACLE	"Warning; Obstacle, Obstacle"
Imminent Obstacle Impact Warning (IOI)	<b>TERRAIN</b>	WARNING OBSTACLE	"Warning; Obstacle, Obstacle"
Reduced Required Terrain Clearance Caution (RTC)	<b>TERRAIN</b>	CAUTION TERRAIN	"Caution; Terrain, Terrain"
Imminent Terrain Impact Caution (ITI)	<b>TERRAIN</b>	CAUTION TERRAIN	"Caution; Terrain, Terrain"
Reduced Required Obstacle Clearance Caution (ROC)	<b>TERRAIN</b>	CAUTION OBSTACLE	"Caution; Obstacle, Obstacle"
Imminent Obstacle Impact Caution (IOI)	<b>TERRAIN</b>	CAUTION OBSTACLE	"Caution; Obstacle, Obstacle"

**TERRAIN-SVS STATUS ANNUNCIATIONS**

Alert Type	PFD/MFD TERRAIN-SVS Page Annunciation	Aural Message
System Test Fail	<b>TER FAIL</b>	"Terrain System Failure"
Terrain Alerting is disabled	<b>TER INHB</b>	None
No GPS position or excessively degraded GPS signal	<b>TER N/A</b>	"Terrain System Not Available"
System Test in progress	<b>TER TEST</b>	None
System Test pass	None	"Terrain System Test OK"
GPS signal is re-established	None	"Terrain System Available"

SYSTEM OVERVIEW

FLIGHT INSTRUMENTS

EIS

AUDIO PANEL & CNS

FLIGHT MANAGEMENT

HAZARD AVOIDANCE

AFCS

ADDITIONAL FEATURES

APPENDICES

INDEX

## DATABASE MANAGEMENT



**CAUTION:** Never disconnect power to the system when loading a database. Power interruption during the database loading process could result in maintenance being required to reboot the system.

The system uses Secure Digital (SD) cards to load and store various types of data. For basic flight operations, SD cards are required for database storage as well as Jeppesen navigation and ChartView database updates. Not all SD cards are compatible with the G1000. Use only SD cards supplied by Garmin or the aircraft manufacturer.



**NOTE:** Loading a database in the system prior to its effective date will result in the expiration date on the power-up screen and the effective date on the AUX-System Status Page being displayed in yellow.



**NOTE:** Garmin requests the flight crew report any observed discrepancies related to database information. These discrepancies could come in the form of an incorrect procedure; incorrectly identified terrain, obstacles and fixes; or any other displayed item used for navigation or communication in the air or on the ground. Go to [FlyGarmin.com](http://FlyGarmin.com) and select "Aviation Data Error Report."



**NOTE:** When loading database updates, the 'DB Mismatch' message will be displayed until database synchronization is complete, followed by turning system power off, then on. Synchronization can be monitored on the AUX-SYSTEM STATUS Page.



**CAUTION:** When downloading updates to the Jeppesen Navigation Database, copy the data to an SD card other than a Garmin Supplemental Data Card. Otherwise, data corruption can occur.

### JEPPESEN DATABASES

The Jeppesen navigation database is updated on a 28-day cycle. The ChartView database is updated on a 14-day cycle. If the ChartView database is not updated within 70 days of the expiration date, ChartView will no longer function. Both of these databases are provided directly from Jeppesen.



**NOTE:** The Jeppesen aviation navigation database is now referred to as the 'navigation database'. Previously this database had been referred to as the 'aviation database'.

The ChartView database should be copied to the Garmin supplied Supplemental Data Card which will reside in the bottom card slot on the MFD. The navigation database must be installed from the Jeppesen or user supplied SD data card. Contact Jeppesen ([www.jeppesen.com](http://www.jeppesen.com)) for subscription and update information.



**NOTE:** After the navigation database is installed, the card may be removed.

### Updating the Jeppesen navigation database:

- 1) Copy the new navigation database to an SD card obtained from Garmin, or the aircraft manufacturer.
- 2) With the G1000 system OFF, insert the SD card containing the new navigation database version into the top card slot of the MFD (label of SD card facing left).
- 3) Turn the G1000 system ON. A prompt similar to the following illustration is displayed:

```
DO YOU WANT TO UPDATE THE ACTIVE NAVIGATION DATABASE?
SELECTING YES WILL OVERWRITE THE ACTIVE NAVIGATION DATABASE.
FROM          TO
REGION:       WORLDWIDE    WORLDWIDE
CYCLE:        1112         1113
EFFECTIVE:    19-NOV-2010    17-DEC-2010
EXPIRES:      17-DEC-2010    14-JAN-2011

NO WILL BE ASSUMED IN 28 SECONDS.
UPDATING NAVIGATION DATABASE, PLEASE WAIT.
```

Figure B-1 Navigation Database Load Prompt

- 4) Press the **YES** Softkey to update the navigation database in the MFD.
- 5) After the update completes, press any key. The display starts in normal mode.

```
DO YOU WANT TO UPDATE THE ACTIVE NAVIGATION DATABASE?
SELECTING YES WILL OVERWRITE THE ACTIVE NAVIGATION DATABASE.
FROM          TO
REGION:       WORLDWIDE    WORLDWIDE
CYCLE:        1104         1105
EFFECTIVE:    09-APR-2011    07-MAY-2011
EXPIRES:      07-MAY-2011    04-JUN-2011

NO WILL BE ASSUMED IN 8 SECONDS.
UPDATING THE ACTIVE NAVIGATION DATABASE, PLEASE WAIT.
.
UPDATED 1 FILES SUCCESSFULLY!
PRESS ANY KEY TO CONTINUE.
CONTINUING IN 8 SECONDS.
```

Figure B-2 Database Update Confirmation

- 6) Turn the G1000 system OFF and remove the SD card from the top card slot.
- 7) Repeat steps 2 through 6 for PFD1.
- 8) Apply power to the system and press the **ENT** Key to acknowledge the startup screen.
- 9) Turn the large **FMS** Knob to select the AUX Page group on the MFD.
- 10) Turn the small **FMS** Knob to select the System Status Page.
- 11) Press the Display Database Selection Softkey to show navigation database information for each display (**MFD1 DB, PFD1 DB**).

MFD1 DATABASE	
NAVIGATION - INTERNAL	
REGION	WORLDWIDE
CYCLE	1102
EFFECTIVE	10-FEB-11
EXPIRES	10-MAR-11
Copyright 2011. Jeppesen Sanderson, Inc.	
BASEMAP - BOTTOM CARD	
REGION	WORLDWIDE
VERSION	4.00
SAFETAXI - BOTTOM CARD	
REGION	US
VERSION	2.34

Figure B-3 Check Database Cycle Number (MFD shown)

## GARMIN DATABASES

The following databases are stored on Supplemental Data Cards provided by Garmin:

- Expanded basemap
- Airport terrain
- SafeTaxi
- Airport Directory (AOPA)
- Terrain
- Obstacle
- FlightCharts or Chartview

After subscribing to the desired database product, these database products will be downloaded and ultimately stored on three Supplemental Data Cards (with the exception of FliteCharts, which is loaded on only one card). Each Supplemental Data Card resides in the bottom card of each display as shown in Figure B-4. These cards must not be removed except to update the databases stored on each card.

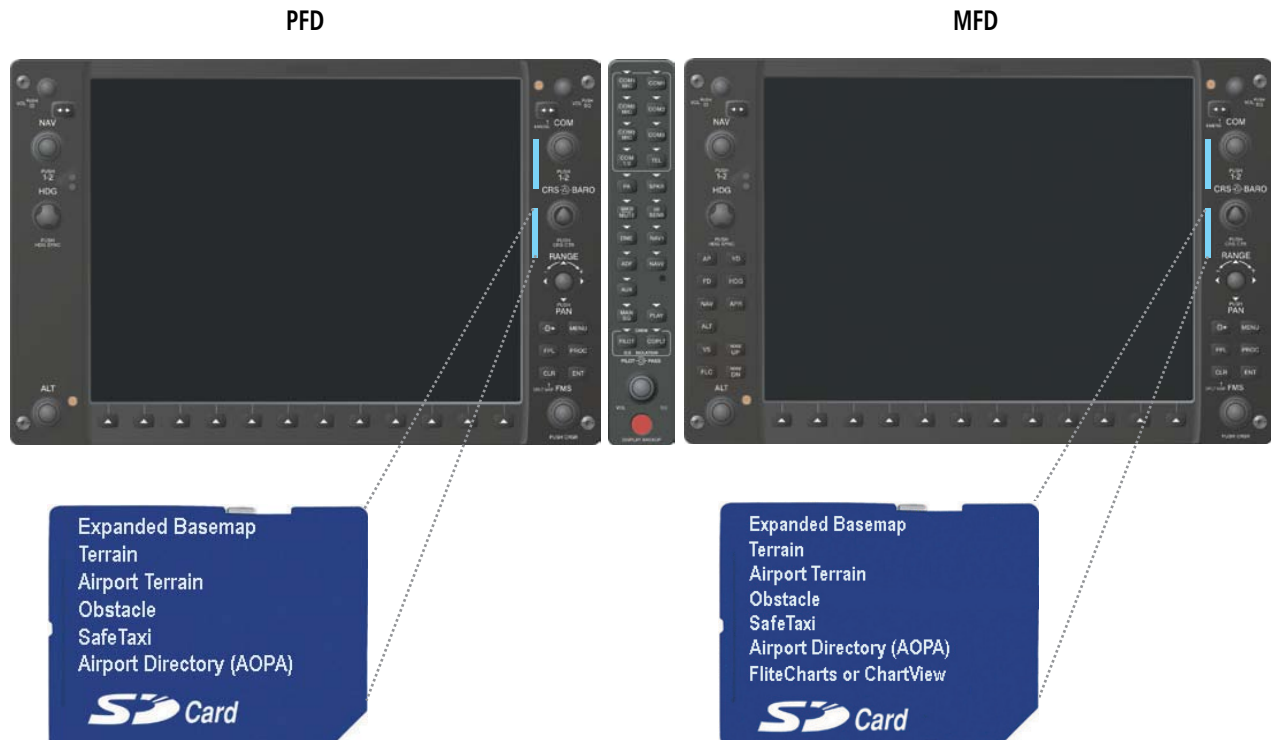

Figure B-4 Correct Database Locations

Since these databases are not stored internally in the displays, a Supplemental Data Card containing identical database versions must be kept in each display unit.

The basemap database contains data for the topography and land features, such as rivers, lakes, and towns. It is updated only periodically, with no set schedule. There is no expiration date.

The terrain database contains the terrain mapping data. The airport terrain database contains increased resolution terrain data around airports. These databases are updated periodically and have no expiration date.

The obstacle database contains data for obstacles, such as towers, that pose a potential hazard to aircraft. Obstacles 200 feet and higher are included in the obstacle database. It is very important to note that not all obstacles are necessarily charted and therefore may not be contained in the obstacle database. This database is updated on a 56-day cycle.



**NOTE:** The data contained in the terrain and obstacle databases comes from government agencies. Garmin accurately processes and cross-validates the data, but cannot guarantee the accuracy and completeness of the data.

The AOPA Airport Directory provides data on airports and heliports throughout the U.S., and offers detailed information for over 5,300 U. S. airports, along with the names and phone numbers of thousands of FBOs. This database is updated four times per year.

The SafeTaxi database contains detailed airport diagrams for selected airports. These diagrams aid in following ground control instructions by accurately displaying the aircraft position on the map in relation to taxiways, ramps, runways, terminals, and services. This database is updated on a 56-day cycle.

The FliteCharts database contains procedure charts for the United States only. This database is updated on a 28-day cycle. If not updated within 180 days of the expiration date, FliteCharts will no longer function.



## AUTOMATIC DATABASE SYNCHRONIZATION FEATURE

The automatic database synchronization feature automatically transfers the database from a single SD database card to the SD cards on the PFD and the MFD to ensure that all databases are synchronized throughout the system. After power-up, the system compares all copies of each applicable database. If similar databases do not match, the most recent valid database is automatically copied to each card in the system that does not already contain that database.

The following databases are checked and synchronized: Basemap, Safetaxi, Airport Terrain, Obstacle, Airport Directory (AOPA), and Terrain. This feature applies only to databases that are stored on the SD card that resides in the bottom slot of each display. This feature does not apply to the navigation database which is stored internally in each display, or to the charts databases (FliteCharts and ChartView) which are only required to be present on the MFD. The typical procedure would be to download new databases to the MFD card, then synchronize the data to the PFD.



**NOTE:** The 9-arc second terrain database may take as long as 100 minutes to synchronize using this method. Therefore the user may want to transfer the data using a PC, or connect the system to a ground power source while performing the database synchronization.

The synchronization progress may be monitored on the AUX-System Status Page in the Sync Status section of the Database Window (Figure B-5). This section shows the synchronization status of each applicable database, including the percent complete, time remaining, and to which displays the databases are being copied. When the synchronization is complete, the status is listed as 'Complete', followed by the displays to which the databases were copied. This sub-section is only present when a sync is occurring or has occurred on the current power-up.

An indication of 'Complete' still requires a power cycle before the synchronized databases will be used by the system.

MFD1 DATABASE	
SYNC STATUS	
NAV STANDBY	Complete PFD1
SAFETAXI	Complete PFD1
OBSTACLE	21% 0:21 PFD1
NAVIGATION - INTERNAL	
REGION	WORLDWIDE
CYCLE	1102
EFFECTIVE	10-FEB-11
EXPIRES	10-MAR-11
Copyright 2011. Jeppesen Sanderson, Inc.	
BASEMAP - BOTTOM CARD	
REGION	WORLDWIDE
VERSION	4.00

Figure B-5 AUX-System Status Page, Database Window

The Display Database Softkey (Figure B-7) is used to place the cursor in the Database Window. Upon first press of the Display Database Softkey, the softkey will change to a selected state (black text on gray background) and the cursor will appear in the Database Window. At this point the user can scroll through

all databases in the Database Window to view status information. If the Display Database Softkey is pressed repeatedly, the softkey will switch between PFD1 and MFD1. Database status information in the Database Window will reflect the database of the selected PFD or MFD. After a successful sync and restart, verify that the proper databases are now in use on the AUX–System Status Page (Figure B-5).

If an error occurs during the synchronization, an error message will be displayed, followed by the affected display in the Sync Status section of the Database Window (Figure B-6). If a synchronization completes on one display, but an error occurs on another, the error message will be displayed with the affected display listed after it. When an error message (Table B-1) is displayed, the problem must be corrected before the synchronization can be completed. A power cycle is required to restart synchronization when ‘Card Full’ or ‘Err’ is shown.

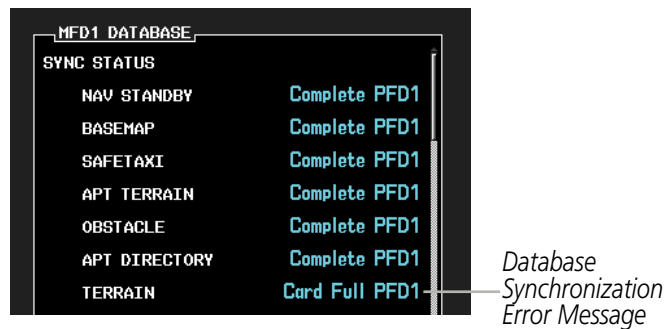

Figure B-6 Synchronization Error Message

Error Message	Description
Canceled	An active synchronization has been canceled using the <b>SYNC DBS</b> Softkey
Card Full	SD card does not contain sufficient memory
Err	Displayed for all other errors that may cause the synchronization process to be halted
Timeout	System timed-out prior to the database transfer completing

Table B-1 Database Synchronization Error Messages

The **SYNC DBS** Softkey (Figure B-7) on the AUX–System Status Page allows the flight crew control over the automatic database synchronization feature. When database synchronization is enabled, the **SYNC DBS** Softkey is displayed as black text on gray background and a confirmation window (Figure B-8) is displayed. When database synchronization is disabled, the softkey is displayed as white text on black background. If the **SYNC DBS** Softkey is pressed while a database synchronization is in progress, the current synchronization process will be canceled.



Figure B-7 SYNC DBS Softkey



Figure B-8 Enable Database Synchronization Prompt

## UPDATING GARMIN DATABASES

The Garmin database updates can be obtained by following the instructions detailed in the 'Navigation Databases' section of the Garmin website ([fly.garmin.com](http://fly.garmin.com)). Once the updated files have been downloaded from the website, a PC equipped with an appropriate SD card reader is used to unpack and program the new databases onto an existing Supplemental Data Card. Equipment required to perform the update is as follows:

- Windows-compatible PC computer (running Windows XP, Vista, or Windows 7)
- SD Card Reader: SanDisk SDDR-93, SanDisk SDDR-99, Verbatim #96504, or equivalent
- Updated database obtained from the Garmin website
- Existing Supplemental Database SD Cards (010-00330-42, or -43) from the PFD and MFD

In some cases it may be necessary to obtain an unlock code from Garmin in order to make the database product functional. It may also be necessary to have the system configured by a Garmin authorized service facility in order to use some database features.

After the data has been copied to the appropriate data card, perform the following steps:

- 1) With system power OFF, remove the MFD database card from the bottom card slot of the MFD.
- 2) Update the Garmin databases on the MFD card.
- 3) Insert the MFD database card into the bottom card slot of the MFD.
- 4) Apply power to the system, check that the databases are initialized and displayed on the power-up screen (Figure B-9). When updating the terrain and FliteCharts databases, a 'Verifying' message may be seen. If this message is present, wait for the system to finish loading before proceeding to step 5.

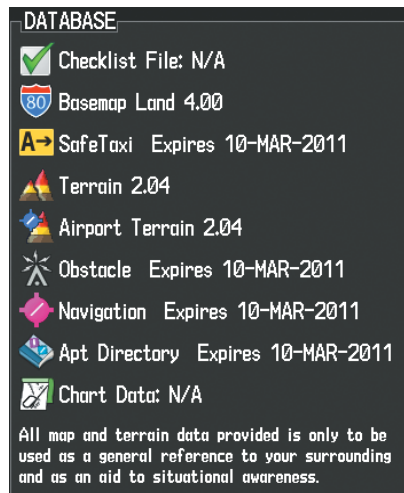

Figure B-9 Database Information on the Power-up Screen

- 5) Acknowledge the Power-up Page agreement by pressing the **ENT** Key or the right most softkey.
- 6) Turn the large **FMS** Knob to select the AUX Page group on the MFD.
- 7) Turn the small **FMS** Knob to select the System Status Page.
- 8) Make sure the **SYNC DBS** Softkey is in the enabled state (Figure B-7).
- 9) Monitor the Sync Status in the Database Window. Wait for all databases to complete syncing, indicated by 'Complete' being displayed as seen in Figure B-6.
- 10) Remove and reapply power to the system.
- 11) Turn the large **FMS** Knob to select the AUX Page group on the MFD.
- 12) Turn the small **FMS** Knob to select the System Status Page.
- 13) Press the Display Database Selection Softkey to show database information for each display (**MFD1 DB**, **PFD1 DB**). Verify the correct database cycle information is shown for each database for each display.



Figure B-10 Display Database Softkey

#### To cancel automatic database synchronization:

- 1) Turn the large **FMS** Knob to select the AUX Page group on the MFD.
- 2) Turn the small **FMS** Knob to select the System Status Page.
- 3) Press the **SYNC DBS** Softkey (if needed) to disable (Figure B-7) automatic database synchronization.
- 4) Acknowledge the cancellation by pressing the **ENT** Key.

## MAGNETIC FIELD VARIATION DATABASE UPDATE

A copy of the current magnetic field variation database (MV DB) is included with the navigation database. At startup, the system compares this version of the MV DB with that presently being used by the AHRS (GRS). If the system determines the MV DB needs to be updated, a prompt is displayed on the Navigation Map Page.

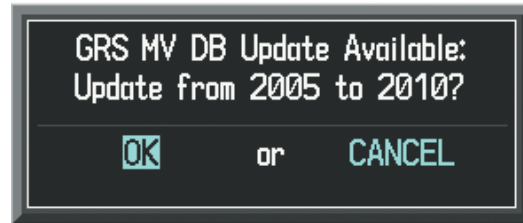

Figure B-11 GRS Magnetic Field Variation Database Update Prompt

### Loading the magnetic field variation database update:

- 1) With 'OK' highlighted, as shown in figure B-11, press the **ENT** Key on the MFD. A progress monitor is displayed as shown in Figure B-12.



Figure B-12 Uploading Database to GRS

- 2) When the upload is complete, the system is ready for use.

**GLOSSARY**

ACC	accuracy	Bearing	The compass direction from the present position to a destination waypoint
ACT, ACTV	active, activate		
ADC	air data computer		
ADF	Automatic Direction Finder	BFO	beat frequency oscillator
ADI	Attitude Direction Indicator	BKSP	backspace
AF	Arc to fix	BRG	bearing
AFCS	Automatic Flight Control System	C	center runway
AFM	Airplane Flight Manual	°C	degrees Celsius
AFRM	airframe	CA	Course to Altitude
AGL	Above Ground Level	CALC	calculator
AHRS	Attitude and Heading Reference System	Calibrated Airspeed	Indicated airspeed corrected for installation and instrument errors.
AIM	Airman's Information Manual	CD	Course to DME distance
AIRMET	Airman's Meteorological Information	CDI	Course Deviation Indicator
ALRT	alert	CDU	Control Display Unit
ALT	altitude	CF	Course to Fix
ALT, ALTN	alternator	CHT	Cylinder Head Temperature
AMPS	amperes	CHKLIST	checklist
ANNUNC	annunciation	CHNL	channel
ANT	antenna	CI	Course to Intercept
AP	autopilot	CLD	cloud
AP DISC	autopilot disconnect	CLR	clear
APR	approach	cm	centimeter
APT	airport, aerodrome	CNS	Communication, Navigation, & Surveillance
ARINC	Aeronautical Radio Incorporated	CO	carbon monoxide
ARSPC	airspace	COM	communication radio
ARTCC	Air Route Traffic Control Center	CONFIG	configuration
ARV	arrival	COOL	coolant
AS	airspeed	COPLT	co-pilot
ASB	Aviation Support Branch	Course	The line between two points to be followed by the aircraft
ASOS	Automated Surface Observing System	Course to Steer	The recommended direction to steer in order to reduce course error or stay on course. Provides the most efficient heading to get back to the desired course and proceed along the flight plan
ATC	Air Traffic Control		
ATCRBS	ATC Radar Beacon System		
ATIS	Automatic Terminal Information Service		
ATK	along-track		
AUTOSEQ	automatic sequence	CR	Course to Radial
AUX	auxiliary	CRG	Cockpit Reference Guide
AWOS	Automated Weather Observing System	CRNT	current
		Crosstrack Error	The distance the aircraft is off a desired course in either direction, left or right
B ALT	barometric altitude		
BARO	barometric setting		
BATT	battery	CRS	course
BC	backcourse	CRS	Course to Steer
		CRSR	cursor
		CTA	Control Area
		CTRL	control

SYSTEM OVERVIEW

FLIGHT INSTRUMENTS

EIS

AUDIO PANEL & CNS

FLIGHT MANAGEMENT

HAZARD AVOIDANCE

AFCS

ADDITIONAL FEATURES

APPENDICES

INDEX

Cumulative	The total of all legs in a flight plan.	Endurance	Flight endurance, or total possible flight time based on available fuel on board
CVR	Cockpit Voice Recorder		
CVRG	coverage		
CWS	control wheel steering	ENG	engine
CYL	cylinder	ENGD	engaged
		ENR	enroute
D ALT	density altitude	Enroute Safe Altitude	The recommended minimum altitude within ten miles left or right of the desired course on an active flight plan or direct-to
DB, DBASE	database		
dBZ	decibels 'Z' (radar return)		
DCLTR, DECLTR	declutter		
DEC FUEL	decrease fuel	ENT	enter
deg	degree	EPE	Estimated Position Error
DEIC, DEICE	de-icing	EPU	Estimated Position Uncertainty
DEP	departure	ERR	error
Desired Track	The desired course between the active "from" and "to" waypoints	ESA	Enroute Safe Altitude
		Estimated Position Error	A measure of horizontal GPS position error derived by satellite geometry conditions and other factors
DEST	destination		
DF	Direct to Fix		
DFLT	default		
DGRD	degrade	Estimated Time of Arrival	The estimated time at which the aircraft should reach the destination waypoint, based upon current speed and track
DH	decision height		
Dilution of Precision	A measure of GPS satellite geometry quality on a scale of one to ten (lower numbers equal better geometry, where higher numbers equal poorer geometry)	Estimated Time Enroute	The estimated time it takes to reach the destination waypoint from the present position, based upon current ground speed
DIR	direction	ETA	Estimated Time of Arrival
DIS	distance	ETE	Estimated Time Enroute
Distance	The 'great circle' distance from the present position to a destination waypoint	EXPIRD	expired
DME	Distance Measuring Equipment	°F	degrees Fahrenheit
DOP	Dilution of Precision	FA	Course From Fix to Altitude
DP	Departure Procedure	FAA	Federal Aviation Administration
DPRT	departure	FADEC	Full Authority Digital Engine Control
DR	dead reckoning	FAF	Final Approach Fix
DSBL	disabled	FAIL	failure
DTK	Desired Track	FC	Course From Fix to Distance
		FCC	Federal Communication Commission
		FCST	forecast
E	empty, east	FD	Course From Fix to DME Distance
ECU	Engine Control Unit	FD	flight director
Efficiency	A measure of fuel consumption, expressed in distance per unit of fuel	FDE	Fault Detection and Exclusion
		FFLOW	fuel flow
EGT	Exhaust Gas Temperature	FIS-B	Flight Information Services-Broadcast
EIS	Engine Indication System		
ELEV	elevation	FISDL	Flight Information Service Data Link
ELEV	elevator	FL	flight level
EMERGCY	emergency	FLC	Flight Level Change
EMI	Electromagnetic Interference	FM	Course From Fix to Manual Termination
ENDUR	endurance		



FMS	Flight Management System	Heading	The direction an aircraft is pointed, based upon indications from a magnetic compass or a properly set directional gyro
FOB	Fuel On Board		
FPL	flight plan		
FPM	Flight Path Marker		
fpm	feet per minute	HF	Hold Terminating at Fix
FREQ	frequency	HFOM	Horizontal Figure of Merit
FRZ	freezing	Hg	mercury
FSS	Flight Service Station	HI	high
ft	foot/feet	HI SENS	High Sensitivity
Fuel Flow	The fuel flow rate, expressed in units of fuel per hour	HM	Hold with Manual Termination
Fuel On Board	The total amount of usable fuel on board the aircraft	Horizontal Figure of Merit	A measure of the uncertainty in the aircraft's horizontal position
		hPa	hectopascal
		HPL	Horizontal Protection Level
G/S, GS	glideslope	hr	hour
GA	go-around	HSDB	High-Speed Data Bus
gal, gl	gallon(s)	HSI	Horizontal Situation Indicator
GBOX	gearbox	HT	heat
GDC	Garmin Air Data Computer	HUL	Horizontal Uncertainty Level
GDL	Garmin Satellite Data Link	Hz	Hertz
GDU	Garmin Display Unit	I	Inner Marker
GEA	Garmin Engine/Airframe Unit	IAF	Initial Approach Fix
GEO	geographic	IAT	Indicated Air Temperature
GFC	Garmin Flight Control	IAU	Integrated Avionics Unit
GIA	Garmin Integrated Avionics Unit	ICAO	International Civil Aviation Organization
GLS	Global Navigation Satellite Landing System	ICS	Intercom System
GMA	Garmin Audio Panel System	ID	Identification/Morse Code Identifier
GMT	Greenwich Mean Time	IDENT, IDNT	identification
GMU	Garmin Magnetometer Unit	IF	Initial Fix
GND	ground	IFR	Instrument Flight Rules
gph	gallons per hour	IG	Imperial gallon
GPS	Global Positioning System	ILS	Instrument Landing System
Grid MORA	Grid Minimum Off-Route Altitude; one degree latitude by one degree longitude in size and clears the highest elevation reference point in the grid by 1000 feet for all areas of the grid	IMC	Instrument Meteorological Conditions
Groundspeed	The velocity that the aircraft is travelling relative to a ground position	in	inch
Ground Track	<i>see Track</i>	INACTV	inactive
GRS	Garmin Reference System	INC FUEL	increase fuel
GS	Ground speed	IND	indicated
GTX	Garmin Transponder	Indicated	Information provided by properly calibrated and set instrumentation on the aircraft panel
		INFO	information
		in HG	inches of mercury
		INT	intersection(s)
		INTEG	integrity (RAIM unavailable)
		IrDA, IRDA	Infrared Data Association
HA	Hold Terminating at Altitude		
HDG	heading	KEYSTK	key stuck
		kg	kilogram

SYSTEM OVERVIEW

FLIGHT INSTRUMENTS

EIS

AUDIO PANEL & CNS

FLIGHT MANAGEMENT

HAZARD AVOIDANCE

AFCS

ADDITIONAL FEATURES

APPENDICES

INDEX

kHz	kilohertz	MEPT	manual electric pitch trim
km	kilometer	MFD	Multi Function Display
kt	knot	MGRS	Military Grid Reference System
		MHz	megahertz
L	left, left runway	MIC	microphone
LAT	latitude	MIN	minimum
LBL	label	Minimum Safe Altitude	Uses Grid MORAs to determine a safe altitude within ten miles of the aircraft present position
lb	pound		
LCD	Liquid Crystal Display	MKR	marker beacon
LCL	local	MOA	Military Operations Area
LED	Light Emitting Diode	MOV	movement
Left Over Fuel On Board	The amount of fuel remaining on board after the completion of one or more legs of a flight plan or direct-to	mpm	meters per minute
		MSA	Minimum Safe Altitude
Left Over Fuel Reserve	The amount of flight time remaining, based on the amount of fuel on board after the completion of one or more legs of a flight plan or direct-to, and a known consumption rate	MSG	message
		MSL	Mean Sea Level
		MT	meter
		mV	millivolt(s)
		MVFR	Marginal Visual Flight Rules
Leg	The portion of a flight plan between two waypoints	N	north
LIFR	Low Instrument Flight Rules	NAV	navigation
LNAV	Lateral Navigation	NAVAID	NAVigation AID
LO	low	NDB	Non-directional Beacon
LOC	localizer	NEXRAD	Next Generation Radar
LOI	loss of integrity (GPS)	nm	nautical mile(s)
LON	longitude	NPT	
LPV	Localizer Performance with Vertical guidance	NRST	nearest
		O	Outer Marker
LRU	Line Replacement Unit	OAT	Outside Air Temperature
LT	left	OBS	Omni Bearing Selector
LTNG	lightning	OFST	offset
LVL	level	OXY	oxygen
		P ALT	pressure altitude
M	Middle Marker	PA	Passenger Address
m	meter	PA	Proximity Advisory
MAG	Magnetic	PASS	passenger(s)
MAG VAR	Magnetic Variation	PC	personal computer
MAHP	Missed Approach Hold Point	PFD	Primary Flight Display
MAN IN	manifold pressure (inches Hg)	PI	Procedure Turn to Course Intercept
MAN SQ	Manual Squelch	PIT, PTCH	pitch
MAP	Missed Approach Point	POSN	position
MASQ	Master Avionics Squelch	PPM	parts per million
MAX	maximum	P. POS	Present Position
MAXSPD	maximum speed (overspeed)	PRES, PRESS	pressure
MDA	barometric minimum descent altitude	PROC	procedure(s), procedure turn
MET	manual electric trim	psi	pounds per square inch
METAR	Meteorological Aviation Routine	PT	Procedure Turn

PTK	parallel track	SMBL	symbol
PTT	Push-to-Talk	SPD	speed
PWR	power	SPI	Special Position Identification
		SPKR	speaker
QTY	quantity	SQ	squelch
		SRVC, SVC	service
R	right, right runway	STAL	stall
RAD	radial	STAR	Standard Terminal Arrival Route
RAIM	Receiver Autonomous Integrity Monitoring	STATS	statistics
		STBY	standby
RAM	random access memory	STD	standard
REF	reference	STRMSCP	Stormscope
REM	remaining (fuel remaining)	SUA	Special Use Airspace
REQ	required	SUSP	suspend
RES	reserve (fuel reserve entered by pilot)	SVS	Synthetic Vision System
		SW	software
REV	reverse, revision, revise	SYS	system
RF	Constant Radius Turn to Fix		
RMI	Radio Magnetic Indicator	T	true
RMT	remote	TA	Traffic Advisory
RNG	range	TACAN	Tactical Air Navigation System
RNWX	runway	TAF	Terminal Aerodrome Forecast
ROL	roll	TAS	True Airspeed
ROM	read only memory	TAS	Traffic Advisory System
rpm	revolutions per minute	TAT	Total Air Temperature
RST FUEL	reset fuel	TCA	Terminal Control Area
RSV	reserve (fuel reserve entered by pilot)	TCAS	Traffic Collision Avoidance System
		TEL	telephone
RT	right	TEMP	temperature
RVRSNRY	reversionary	TERM	terminal
RX	receive	TF	Track Between Two Fixes
		TFR	Temporary Flight Restriction
S	south	T HDG	True Heading
SA	Selective Availability	TIS	Traffic Information System
SAT	Static Air Temperature	TIT	Turbine Inlet Temperature
SBAS	Satellite-Based Augmentation System	TKE	Track Angle Error
		TMA	Terminal Maneuvering Area
SCIT	Storm Cell Identification and Tracking	TMR/REF	Timer/Reference
		Topo	topographic
SD	Secure Digital	Track	Direction of aircraft movement relative to a ground position; also 'Ground Track'
sec	second(s)		
SEL, SLCT	select	Track Angle Error	The angle difference between the desired track and the current track
SFC	surface		
SIAP	Standard Instrument Approach Procedures	TRG	target
		TRK	track
SID	Standard Instrument Departure	TRSA	Terminal Radar Service Area
SIGMET	Significant Meteorological Information	TRUNC	truncated
		TTL	total
Sim	simulator	TURN	procedure turn
SLP/SKD	slip/skid		

SYSTEM OVERVIEW

FLIGHT INSTRUMENTS

EIS

AUDIO PANEL & CNS

FLIGHT MANAGEMENT

HAZARD AVOIDANCE

AFCS

ADDITIONAL FEATURES

APPENDICES

INDEX

TX	transmit	VOL	volume
UNAVAIL	unavailable	VOR	VHF Omni-directional Range
USR	user	VORTAC	very high frequency omnidirectional range station and tactical air navigation
UTC	Coordinated Universal Time	VPL	Vertical Protection Level
UTM/UPS	Universal Transverse Mercator/ Universal Polar Stereographic Grid	VPROF	VNV profile, vertical profile
V, Vspeed	velocity (airspeed)	VPTH	VNV path, vertical path
VA	Heading Vector to Altitude	VR	Heading Vector to Radial
VAPP	VOR approach	VS	vertical speed
VAR	variation	VSI	Vertical Speed Indicator
VD	Heading Vector to DME Distance	VSR	Vertical Speed Required
Vdc	volts, direct current	VTF	vector to final
VERT	vertical	W	watt(s), west
Vertical Figure of Merit	A measure of the uncertainty in the aircraft's vertical position	WAAS	Wide Area Augmentation System
Vertical Speed Required	The vertical speed necessary to descend/climb from a current position and altitude to a defined target position and altitude, based upon current groundspeed	WARN	warning (GPS position error)
		WGS-84	World Geodetic System - 1984
		WPT	waypoint(s)
		WW	world wide
		WX	weather
VFOM	Vertical Figure of Merit	XFER, XFR	transfer
VFR	Visual Flight Rules	XPDR	transponder
VHF	Very High Frequency	XTALK	cross-talk
VI	Heading Vector to Intercept	XTK	cross-track
VLOC	VOR/Localizer Receiver		
VM	Heading Vector to Manual Termination		
VMC	Visual Meteorological Conditions		
VNAV, VNV	vertical navigation		

## FREQUENTLY ASKED QUESTIONS

If a particular aspect of G1000 operational capability is not addressed by these commonly asked questions or in the index, contact Garmin (see the copyright page or back cover for contact information) or a Garmin-authorized dealer. Garmin is dedicated to supporting its products and customers.

### WHAT IS SBAS?

The Satellite Based Augmentation System (SBAS) uses a system of ground stations to correct any GPS signal errors. These ground stations correct for errors caused by ionospheric disturbances, timing, and satellite orbit errors. It also provides vital integrity information regarding the health of each GPS satellite. The signal correction is then broadcast through geostationary satellites. This correction information can then be received by any SBAS-enabled GPS receiver.

SBAS is designed to provide the additional accuracy, availability, and integrity necessary to enable users to rely on GPS for all phases of flight.

There are several SBAS systems serving different parts of the world. The Wide Area Augmentation System (WAAS) is currently available in the United States, including Alaska and Hawaii. The European Geostationary Navigation Overlay Service (EGNOS) offers coverage of Europe, parts of the middle east and northern Africa. The Multi-functional Satellite Augmentation System (MSAS) covers mainly Japan and parts of northern Australia.

### HOW DOES SBAS AFFECT APPROACH OPERATIONS?

Both LNAV/VNAV and LPV approaches use the accuracy of SBAS to include vertical (glide path) guidance capability. The additional accuracy and vertical guidance capability allows improved instrument approaches to an expanded number of airports throughout the U.S.

The implementation of LPV approaches further improves precision approach capabilities. LPV approaches are designed to make full use of the improved GPS signal from the SBAS. This approach combines the LNAV/VNAV vertical accuracy with lateral guidance similar to the typical Instrument Landing System (ILS). LPV approaches allow lower approach minimums.

### WHAT IS RAIM AND HOW DOES IT AFFECT APPROACH OPERATIONS?

When SBAS is unavailable, the GPS receivers use Receiver Autonomous Integrity Monitoring (RAIM) to perform the following functions:

- Monitor and verify integrity and geometry of tracked GPS satellites
- Notify pilot when satellite conditions do not provide necessary coverage to support a certain phase of flight
- Predict satellite coverage of a destination area to determine whether the number of available satellites is sufficient to satisfy requirements (refer to the System Overview Section for instructions on RAIM prediction)
- Detect and exclude bad satellites from the navigation solution (Fault Detection and Exclusion, FDE)

RAIM ensures that satellite geometry allows for a navigation solution calculation within a specified protection limit (4.0 nm for oceanic, 2.0 nm for enroute, 1.0 nm for terminal, and 0.3 nm for non-precision approaches). Without SBAS or RAIM, GPS position accuracy integrity cannot be monitored.

## WHY MIGHT THERE BE NO APPROACHES AVAILABLE FOR A FLIGHT PLAN?

Approaches are available for the final destination airport in a flight plan or as a direct-to (keep in mind that some VOR/VORTAC identifiers are similar to airport identifiers). If a destination airport does not have a published approach, the G1000 indicates “NONE” for the available procedures.

## WHAT HAPPENS WHEN AN APPROACH IS SELECTED? CAN A FLIGHT PLAN WITH AN APPROACH, A DEPARTURE, OR AN ARRIVAL BE STORED?

When an approach, departure, or arrival is loaded into the active flight plan, a set of approach, departure, or arrival waypoints is inserted into the flight plan, along with a header line showing the title of the selected instrument procedure. The original enroute portion of the flight plan remains active, unless the instrument procedure is activated. This may be done either when the procedure is loaded or at a later time.

Flight plans can also be stored with an approach, a departure, or an arrival. Note that the active flight plan is erased when the system is turned off. Also, the active flight plan is overwritten when another flight plan is activated. When storing flight plans with an approach, a departure, or an arrival, the G1000 uses the waypoint information from the current database to define the waypoints. If the database is changed or updated, the G1000 System automatically updates the information, provided the procedure has not been modified. Should an approach, departure, or arrival procedure no longer be available, the flight plan becomes locked until the procedure is deleted from the flight plan.

## CAN “SLANT GOLF” (“/G”) BE FILED USING THE G1000?

“/G” may be filed for a flight plan. The G1000 System meets the requirements of TSO-C129a with GIA 63 and TSO-C146a with GIA 63W Class A1 or A2 installation. GPS approaches are not to be flown with an expired database. See the approved Airplane Flight Manual (AFM) as well as the Aeronautical Information Manual (AIM) for more information.

## WHAT DOES THE OBS SOFTKEY DO?

The **OBS** Softkey is used to select manual sequencing of waypoints. Activating OBS mode sets the current active-to waypoint as the primary navigation reference and prevents the system from sequencing to the next waypoint in a flight plan. When OBS mode is cancelled, automatic waypoint sequencing is continued, and the G1000 automatically activates the next waypoint in the flight plan once the aircraft has crossed the present active waypoint.

### Normal (OBS not activated)

- Automatic sequencing of waypoints
- Manual course change on HSI not possible
- Always navigates ‘TO’ the active waypoint
- Must be in this mode for final approach course

### OBS

- Manual sequencing - ‘holds’ on selected waypoint
- Manually select course to waypoint from HSI
- Indicates ‘TO’ or ‘FROM’ waypoint
- Cannot be set for final approach course or published holding patterns

When OBS mode is active, the G1000 allows the pilot to set a desired course to/from a waypoint using the **CRS/BARO** Knob and HSI (much like a VOR).

The most common application for using the **OBS** Softkey is the missed approach. The G1000 suspends automatic waypoint sequencing (indicated by a 'SUSP' annunciation placed on the HSI) when the missed approach point (MAP) is crossed. This prevents the G1000 from automatically sequencing to the missed approach holding point (MAHP). During this time, the **OBS** Softkey designation changes to **SUSP**. Selecting the **SUSP** Softkey reactivates automatic waypoint sequencing. The **OBS** Softkey then resumes its normal functionality.

### WHY MIGHT THE G1000 NOT AUTOMATICALLY SEQUENCE TO THE NEXT WAYPOINT?

The G1000 only sequences flight plan waypoints when automatic sequencing is enabled (i.e., no 'OBS' or 'SUSP' annunciation on the HSI). For automatic sequencing to occur, the aircraft must also cross the *bisector* of the turn being navigated. The bisector is a line passing through the waypoint common to two flight plan legs at an equal angle from each leg.

### HOW CAN A WAYPOINT BE SKIPPED IN AN APPROACH, A DEPARTURE, OR AN ARRIVAL?

The G1000 allows the pilot to manually select any approach, departure, or arrival leg as the active leg of the flight plan. This procedure is performed on the MFD from the Active Flight Plan Page by highlighting the desired waypoint and selecting the **ACT LEG** Softkey then the **ENT** Key to approve the selection. The GPS then provides navigation along the selected flight plan leg.

### WHEN DOES TURN ANTICIPATION BEGIN?

The G1000 smooths adjacent leg transitions based on a normal 15° bank angle (with the ability to roll up to 30°) and provides three pilot cues for turn anticipation:

- A waypoint alert ('Next DTK ###° in # seconds' or 'Next HDG ###° in # seconds') appears on the PFD 10 seconds before the turn point and flashes as it counts down to zero.
- A flashing turn advisory ('Turn [right/left] to ###° in # seconds') appears on the PFD 10 seconds before the turn and flashes as it counts down to zero. 'Turn [right/left] to ###° now' or 'Next [DTK/HDG] to ###° now' is displayed when the pilot is to begin the turn and the HSI (GPS mode) automatically sequences to the next DTK or HDG value.
- The To/From indicator on the HSI flips momentarily to indicate that the midpoint of the turn has been crossed.

### WHEN DOES THE CDI SCALE CHANGE?

Once a departure is activated, the G1000 Course Deviation Indicator (CDI) full scale deflection is set to 0.3 nm. The CDI scale changes to 1.0 nm (terminal mode) then ramps up to 2.0 nm (enroute mode) at 30 nm from the departure airport. When 31 nm from the destination, the CDI scale smoothly transition from 2.0 nm back to 1.0 nm (terminal mode). At 2.0 nm before the FAF during an active approach, the CDI scale transitions down further based on the type of approach activated (LNAV, LNAV/VNAV, LPV). When a missed approach is activated, the CDI is set to 0.3 nm. See the Flight Instruments Section for more details on CDI scaling.



## WHY DOES THE HSI NOT RESPOND LIKE A VOR WHEN OBS MODE IS ACTIVE?

Unlike a VOR, the CDI scale used on GPS equipment is based on the crosstrack distance to the desired course, not on the angular relationship to the destination. Therefore, the CDI deflection on the GPS is constant regardless of the distance to the destination and does not become less sensitive when further away from the destination.

## WHAT IS THE CORRECT MISSED APPROACH PROCEDURE? HOW IS THE MISSED APPROACH HOLDING POINT SELECTED?

To comply with TSO specifications, the G1000 does not automatically sequence past the MAP. The first waypoint in the missed approach procedure becomes the active waypoint when the **SUSP** Softkey is selected *after* crossing the MAP. All published missed approach procedures must be followed, as indicated on the approach plate.

To execute the missed approach procedure prior to the MAP (not recommended), select the Active Flight Plan Page and use the **ACT LEG** Softkey to activate the missed approach portion of the procedure.

## AFTER A MISSED APPROACH, HOW CAN THE SAME APPROACH BE RE-SELECTED? HOW CAN A NEW APPROACH BE ACTIVATED?



**NOTE:** Do not attempt to reactivate the current approach prior to crossing the missed approach point (MAP). If an attempt to do so is made, an alert message “Are you sure you want to discontinue the current approach?” appears. The G1000 directs the pilot back to the transition waypoint and does not take into consideration any missed approach procedures, if the current approach is reactivated.

After flying the missed approach procedure, the pilot may reactivate the same approach for another attempt by pressing the **PROC** Key. Once the clearance is given for another attempt, activate the approach by highlighting ‘ACTIVATE APPROACH’ using the large **FMS** Knob and pressing the **ENT** Key. The G1000 provides navigation along the desired course to the waypoint and rejoins the approach in sequence from that point.

To activate a new approach for the same airport, select the new procedure by pressing the **PROC** Key. Choose ‘SELECT APPROACH’, select the desired approach from the list shown, and press the **ENT** Key. Select the desired transition, then activate the approach using the **ENT** Key.

To activate a new approach to a different airport, press the **Direct-to** Key and select the desired airport using the **FMS** Knobs. Press the **ENT** Key to accept the selected airport, then follow the steps in the preceding paragraph to select an approach for the new airport.

## GENERAL TIS INFORMATION



**NOTE:** Aircraft without an operating transponder are invisible to TIS.



**NOTE:** TIS is not intended to be used as a collision avoidance system and does not relieve the pilot of the responsibility to “see and avoid” other aircraft. TIS should not be used for avoidance maneuvers during instrument meteorological conditions (IMC) or when there is no visual contact with the intruder aircraft.

The Traffic Information Service (TIS) provides traffic advisory information to non-TAS/TCAS-equipped aircraft. TIS is a ground-based service providing the relative locations of all ATCRBS Mode-A and Mode-C transponder equipped aircraft within a specified service volume. The TIS ground sensor uses real-time track reports to generate traffic notification. The G1000 System displays TIS traffic information on the Traffic Map Page of the MFD. TIS information may also be displayed for overlay on the MFD Navigation Map Page, as well as on the PFD Inset Map. Surveillance data includes all transponder-equipped aircraft within the coverage volume. The G1000 System displays up to eight traffic targets within a 7.5-nm radius, from 3,000 feet below, to 3,500 feet above the requesting aircraft.

The main difference between the Traffic Information System (TIS) and Traffic Advisory (TAS) or Traffic Collision Avoidance Systems (TCAS) is the source of surveillance data. TAS/TCAS uses an airborne interrogator with a half-second update rate, while TIS utilizes the terminal Mode-S ground interrogator and accompanying data link to provide a five-second update rate. TIS and TAS/TCAS have similar ranges.

TIS relies on surveillance of the Mode-S radar system, which is a “secondary surveillance” radar system similar to that used by ATCRBS. Many limitations are inherent in secondary radar surveillance. Information provided by TIS is neither better nor more accurate than the information used by ATC. TIS is intended only to assist in visual acquisition of other aircraft in visual meteorological conditions (VMC). While TIS is a useful aid for visual traffic avoidance, system limitations must be considered to ensure proper use. No recommended avoidance maneuvers are given, nor authorized, as a direct result of a TIS intruder display or TIS advisory.

- TIS operation may be intermittent during turns or other maneuvering.
- TIS is dependent on two-way, line-of-sight communications between the aircraft and the Mode-S radar antenna. Whenever the structure of the aircraft comes between the transponder antenna and the ground-based radar antenna, the signal may be temporarily interrupted.



**NOTE:** Refer to the TIS Limitations section of the Aeronautical Information Manual (AIM) for a more comprehensive explanation of limitations and anomalies associated with TIS.



**NOTE:** TIS is unavailable at low altitudes in many areas of the United States. This is often the case in mountainous regions.



**WARNING:** *Garmin is not responsible for Mode S geographical coverage. Operation of the ground stations is the responsibility of the FAA. Refer to the AIM for a Terminal Mode S radar site map.*

TIS information is collected during a single radar sweep. Collected information is then sent through the Mode S uplink on the next radar sweep. Because of this, the surveillance information is approximately five seconds old. TIS ground station tracking software uses prediction algorithms to compensate for this delay. These algorithms use track history data to calculate expected intruder positions consistent with the time of display. Occasionally, aircraft maneuvering may cause variations in this calculation and create slight errors on the Traffic Map Page which affect relative bearing information and the target track vector and may delay display of the intruder information. However, intruder distance and altitude typically remain relatively accurate and may be used to assist in spotting traffic. The following errors are common examples:

- When the client or intruder aircraft maneuvers excessively or abruptly, the tracking algorithm may report incorrect horizontal position until the maneuvering aircraft stabilizes.
- When a rapidly closing intruder is on a course that intercepts the client aircraft course at a shallow angle (either overtaking or head-on) and either aircraft abruptly changes course within 0.25 nm, TIS may display the intruder aircraft on the incorrect side of the client aircraft.

These are rare occurrences and are typically resolved within a few radar sweeps once the client/intruder aircraft course stabilizes.

Pilots using TIS can provide valuable assistance in the correction of malfunctions by reporting observations of undesirable performance. Reports should identify the time of observation, location, type and identity of the aircraft, and describe the condition observed. Reports should also include the type of transponder and transponder software version. Since TIS performance is monitored by maintenance personnel, not ATC, malfunctions should be reported in the following ways:

- By telephone to the nearest Flight Service Station (FSS) facility
- By FAA Form 8000-7, Safety Improvement Report (postage-paid card can be obtained at FAA FSSs, General Aviation District Offices, Flight Standards District Offices, and General Aviation Fixed Base Operators)

## MAP SYMBOLS

### AIRPORTS

Item	Symbol
Unknown Airport	
Non-towered, Non-serviced Airport	
Towered, Non-serviced Airport	
Non-towered, Serviced Airport	
Towered, Serviced Airport	
Restricted (Private) Airport	
Heliport	

### NAVAIDS

Item	Symbol
Intersection	
LOM (compass locator at outer marker)	
NDB (non-directional radio beacon)	
VOR	
VOR/DME	
VOR/ILS	
VORTAC	
TACAN	

### BASEMAP

Item	Symbol
Interstate Highway	
State Highway	
US Highway	
National Highway	
City	
State/Province Border	-- ST/PRV BORDER --
International Border	INTL BORDER
Road	
Railroad	
Latitude/Longitude	

### AIRSPACE BOUNDARIES

Item	Symbol
ICAO Control Area	
Class B Airspace	
Mode C Tower Area	
Warning Area	
Alert Area	
Caution Area	
Danger Area	
Prohibited Area	
Restricted Area	
Training Area	
Unknown Area	
Class C	
Terminal Radar Service Area	
Mode C Area	
Military Operations Area (MOA)	

SYSTEM OVERVIEW

FLIGHT INSTRUMENTS

EIS

AUDIO PANEL & CNS

FLIGHT MANAGEMENT

HAZARD AVOIDANCE

AFCS

ADDITIONAL FEATURES

APPENDICES

INDEX

### HAZARD AVOIDANCE FEATURES

Feature	Symbol
Terrain Proximity display enabled	
Traffic display enabled	
NEXRAD display enabled	
Cloud Top display enabled	
Echo Top display enabled	
XM Lightning display enabled	
Cell Movement display enabled	
SIGMETs/AIRMETs display enabled	
METARs display enabled	
City Forecast display enabled	
Surface Analysis display enabled	
Freezing Levels display enabled	
Winds Aloft display enabled	
County Warnings display enabled	
Cyclone Warnings display enabled	
Loss of hazard avoidance feature (loss of GPS position)	
Turbulence	
Icing Potential	
PIREPs	
AIREPs	

### TRAFFIC

Item	Symbol
Non-threat Traffic	
Proximity Advisory (not used with TIS)	
Traffic Advisory, Out of Range	
Traffic Advisory	

### MISCELLANEOUS

Item	Symbol
ARTCC Frequency or FSS Frequency	
Map Pointer (when panning)	
Elevation Pointer (on Topography Scale when panning)	
Measuring Pointer	
Wind Vector	
Overzoom Indicator	
User Waypoint	
Vertical Navigation Along Track Waypoint	
Parallel Track Waypoint	
Unanchored Flight Path Waypoint	
Top of Descent (TOD)	
Bottom of Descent (BOD)	
Navigating using Dead Reckoning	

OBSTACLE DATABASE













Unlighted Obstacle		Lighted Obstacle		Obstacle Location
< 1000' AGL	> 1000' AGL	< 1000' AGL	> 1000' AGL	
				Red obstacle is above or within 100 ft below the aircraft altitude
				Yellow obstacle is between 100 ft and 1000 ft below the aircraft altitude
				Gray obstacle is more than 1000 ft below aircraft altitude

Table F-1 Obstacle Colors

TERRAIN AVOIDANCE COLORS AND SYMBOLS

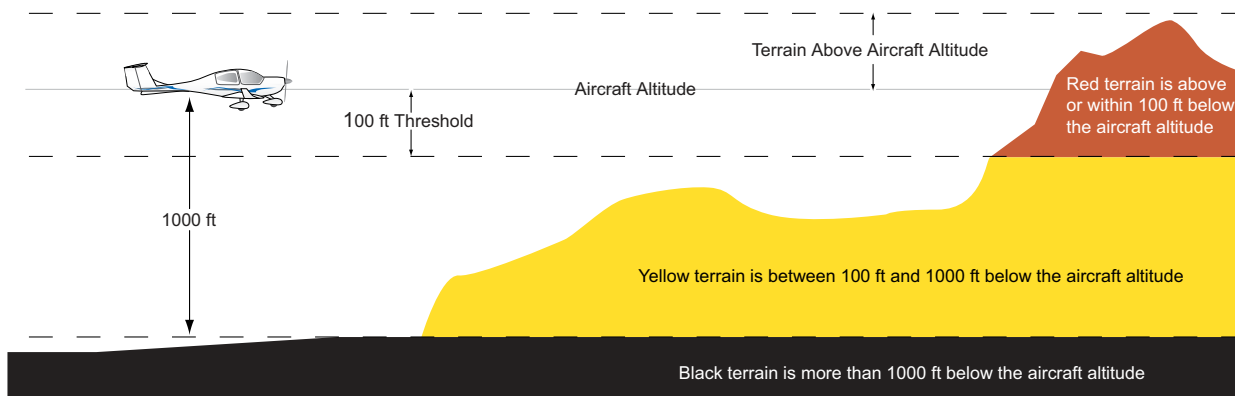

Figure F-1 Terrain Altitude/Color Correlation

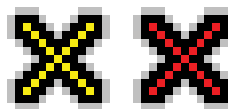

Figure F-2 Potential Impact Points

SYSTEM OVERVIEW

FLIGHT INSTRUMENTS

EIS

AUDIO PANEL & CNS

FLIGHT MANAGEMENT

HAZARD AVOIDANCE

AFCS

ADDITIONAL FEATURES

APPENDICES

INDEX

BLANK PAGE



**A**

Activate a Flight Plan-----205  
 Active channel-----454  
 Active frequency ----- 92, 101  
     ADF-----110  
 ADF  
     ADF mode ----- 110, 112  
     ANT mode-----112  
     Volume-----110  
 ADF/BFO -----112  
 ADF/DME tuning -----113  
 ADF volume-----112  
 AHRS-----13, 480, 485  
 Air Data Computer (ADC) -----3  
 AIREP -----304  
 Airport  
     Information -----164  
 Airspace Alerts ----- 179, 180, 271  
 Airspeed indicator -----44, 46  
 Airspeed Reference -----358  
 Airspeed Trend Vector ----- 46  
 Airways  
     Collapsed-----218  
     Expanded-----218  
 Alerting system-----471  
 Alert levels -----472  
 Alerts -----471  
     Aircraft-----473  
     Audio voice -----474  
 Alerts window ----- 69  
 Along Track Offset ----- 209, 210  
 ALT -----267  
 Altimeter -----44, 49  
 Altitude  
     Constraints-----221, 254  
 Altitude alerting-----72  
 Altitude capture-----355, 364  
 Altitude Hold Mode (ALT)-----356  
 Altitude Reference -----355, 356, 364  
 Annunciations  
     AFCS Status-----488  
     G1000 System-----10, 475-476  
     Test tone-----12, 472  
 Annunciation Window -----45  
 Annunciator lights -----119  
 ANT/BFO -----112  
 AOPA Airport Directory-----393, 449, 450, 451, 493  
 Approach-----506  
     Activating -----234  
     ILS -----387  
     Loading -----202, 231, 233  
     Missed -----389  
     Removing-----234  
     Approach box -----435

Approach Mode, AFCS -----374, 387, 388  
 APR softkey -----233, 239  
 Arrival procedure-----187, 200, 228, 230, 252, 254, 263  
 Attitude and Heading Reference System (AHRS) ----3, 8, 13-14  
 Attitude indicator -----44  
 Audio alerting system -----472  
 Audio Panel-----2, 10  
 Audio panel controls  
     SPKR -----119  
 Audio panel fail-safe operation-----126  
 Automatic Flight Control System (AFCS)-----1, 347-392  
     Controls -----348-349  
     Example procedures -----378-385  
     Status Annunciations -----391  
     Status Box -----351  
 Automatic squelch -----100  
 Autopilot -----347, 376-377  
     Disconnect -----349, 368, 377  
 Auto-tuning-----108  
 Auto-tuning, COM-----95  
 Auto-tuning, NAV-----104  
 Auto Zoom-----132  
 Auxiliary Pages (AUX)-----31  
 AUX - system status page 410, 430, 431, 446, 447, 448, 450  
 Aviation Symbols-----144, 187

**B**

Backlighting -----42  
 Barometric altimeter setting -----44, 50  
 Bearing/distance, measuring -----139  
 Bearing information -----57  
 Bearing Information Windows -----45  
 Bearing pointer-----56  
 Bearing source -----57

**C**

Calibrated Airspeed-----236  
 CDI -----230, 243, 254, 262, 269  
 CELL MOV Softkey -----290  
 Chart Not Available-----413, 433  
 Chart options-----421, 440  
 Chart setup box -----427, 444  
 ChartView-----393, 412, 430  
 ChartView database-----430  
 ChartView plan view -----422  
 ChartView profile view-----423  
 Checklists -----459-460  
 Checklist softkeys -----459  
 CLD TOP Softkey -----288  
 Closest Point-----218  
 COM channel spacing-----99  
 COM frequency box -----89, 92

SYSTEM OVERVIEW

FLIGHT INSTRUMENTS

EIS

AUDIO PANEL & CNS

FLIGHT MANAGEMENT

HAZARD AVOIDANCE

AFCS

ADDITIONAL FEATURES

APPENDICES

INDEX

Command Bars, flight director-----352

Communication (COM) frequency box ----- 44

COM tuning failure-----126

Controls

    AFCS ----- 348–349

    PFD/MFD -----18–19, 28

    Softkeys----- 20–23

Control Wheel Steering (CWS)----- 349, 377

Copy a Flight Plan -----205

Course Deviation Indicator (CDI)----- 58–59

    Changing scale -----507

Course To Fix -----235

**D**

Databases-----7, 8, 12, 490

Database synchronization ----- 494, 495, 497

Data entry----- 27–28

Data Link Receiver ----- 4

Datalink receiver troubleshooting -----469

Data logging-----463

Data Logging -----462

Date and time ----- 34

Day/Night views----- 427, 444

Day view -----427, 428, 444, 445

DB Mismatch -----490

Dead Reckoning----- 74

DEC FUEL softkey ----- 83

Decision Height (DH) -----45, 73

Declutter, display----- 75

Declutter maps -----21, 26

Delete Flight Plans-----206

Deleting

    An entire airway----- 207, 208

    An entire procedure ----- 207, 208

    An individual waypoint----- 207, 208

    Flight Plan Items -----207

Density Altitude -----238

Departure

    Procedure -----198, 212, 225, 227

    Select-----225, 228, 231, 234

    Time -----236

    Timer ----- 41

Departure procedure chart ----- 417, 437

Dilution of Precision (DOP)----- 17

Direct-to- 157, 181, 182, 183, 184, 185, 219, 220, 252, 254, 269

Display backup -----10, 91

Display controls ----- 18–25

DME

    HOLD mode -----113

    NAV1 mode -----113

    NAV2 mode-----113

    Tuning mode----- 110, 113

DME information-----56, 57

DR ----- 74

DR mode ----- 74

**E**

ECHO TOP Softkey -----287

Electronic checklists -----393, 459, 460, 461

Emergency checklist -----461

Emergency frequency-----126

Engine Airframe Unit ----- 3

Engine Indication System (EIS)----- 77–86

Engine Manifold Pressure (MAN IN HG) ----- 79, 81, 83

ENGINE softkey ----- 77

Entertainment inputs-----124

Estimated Position Error (EPE) ----- 17

**F**

Fail-safe operation-----126

Field of View (SVS)-----155

Flight director-----347, 350–351

    Pitch modes----- 353–359

    Roll modes -----369

Flight Level Change Mode (FLC) ----- 358, 383

Flight plan

    Closest point to reference -----218

    Storing -----506

Flight timer----- 40

FliteCharts ----- 393, 432

FliteCharts®-----393

FliteCharts cycle-----447

FliteCharts database -----432

FliteCharts expiration -----447

FliteCharts functions -----432

FliteCharts softkeys-----432

FPA----- 221, 259

Frequency

    Nearest -----177

Frequency spacing ----- 99

Frequency transfer arrow ----- 93

Frequently asked questions-----505

Fuel

    Efficiency -----238

    Endurance-----238

    Remaining-----238

    Required-----238

    Statistics-----238

Fuel calculations ----- 82

Fuel Flow (FFLOW GPH) -----79, 83

Fuel flow totalizer----- 83

Fuel on Board ----- 238  
 Fuel Quantity (FUEL QTY GAL)----- 79, 83  
 Fuel remaining, calculated (GAL REM) ----- 83  
 Fuel remaining (GAL REM) ----- 83  
 Fuel used (GAL USED)----- 83

**G**

GD1 69/69A ----- 274  
 GFC 700 AFCS----- 347–392  
 Glidepath----- 267  
 Glidepath indicator ----- 52  
 Glidepath Mode (GP)----- 365, 374, 388  
 Glideslope----- 267  
 Glideslope indicator ----- 52  
 Glideslope Mode (GS)----- 367, 387  
 Global Positioning System (GPS)  
     Navigation ----- 181–272  
 Go Around Mode (GA)----- 349, 368, 389–390  
 GPS Window----- 495  
 GTX 33 Transponder----- 114

**H**

Heading ----- 44  
 Heading bug----- 44  
 Heading Select Mode (HDG) ----- 371, 379  
 HI SENS----- 109  
 Horizontal situation indicator ----- 44, 53  
 HSI double green arrow----- 101  
 HSI magenta arrow----- 101  
 HSI single green arrow----- 101

**I**

Icing----- 302  
 ID indicator ----- 103  
 ILS approach----- 387  
 Indicated airspeed ----- 46  
 Indicated Altitude ----- 236  
 Info box----- 436  
 Inset Map, PFD ----- 45  
 Integrated Avionics Unit (IAU) ----- 2  
 Intercom system (ICS) ----- 124  
 Intersection  
     Information ----- 165–166  
 Inverting a flight plan ----- 205  
 IOI ----- 328

**J**

Jeppesen aviation database----- 490

**L**

Land Symbols----- 143

Line Replaceable Units (LRU) ----- 2–5, 11  
 LNAV----- 243  
 Logging Data ----- 462  
 LO SENS ----- 109  
 Low Altitude Annunciation ----- 72  
 LPV----- 243, 269  
 LPV approach----- 378

**M**

Manual Electric Trim (MET)----- 347, 376  
 Map  
     Panning----- 134  
     Map Pages (MAP)----- 30  
     Map symbols ----- 511  
     Marker beacon ----- 109  
     Marker beacon annunciations ----- 70  
     MASQ processing----- 87  
     Measurement units, changing displayed ----- 35  
     Menus ----- 27  
 Message advisories - 473, 477, 478, 480, 484, 485, 486, 487  
 Minimum Descent Altitude (MDA) ----- 45, 73  
 Missed Approach----- 187, 235, 240, 243, 269, 389  
 Mode S ----- 114, 115  
 Morse code identifier----- 103  
 Multi Function Display (MFD)----- 2  
     Controls ----- 18–19  
     Softkeys----- 25

**N**

National Weather Service----- 300  
 NAV frequency box ----- 89  
 Navigation  
     Database ----- 221, 222  
     Map ----- 183  
 Navigation Mode, AFCS----- 372–373, 381–382  
 Navigation mode selection ----- 101  
 Navigation (NAV) frequency box ----- 44  
 Navigation source ----- 58–59  
 Navigation status box----- 44  
 Nav radio selection ----- 101  
 NAV tuning knob ----- 103  
 Nearest  
     Airport ----- 161, 162, 163, 164, 177–180, 233  
     Airport Minimum Runway Length ----- 164  
     Airports Page ----- 162, 163, 164  
     Airport Surface Matching----- 164  
     VOR ----- 177–178  
 Nearest Pages (NRST)----- 31  
 NEXRAD Softkey ----- 283  
 Night view ----- 427, 428, 444, 445

SYSTEM OVERVIEW

FLIGHT INSTRUMENTS

EIS

AUDIO PANEL & CNS

FLIGHT MANAGEMENT

HAZARD AVOIDANCE

AFCS

ADDITIONAL FEATURES

APPENDICES

INDEX

Non-path descent-----363, 385–386  
 Normal display operation-----9  
 NOTAMs-----419

**O**

OBS Mode-----63, 63–64  
 Obstacles-----479, 483  
 Oil pressure-----80  
 Oil Pressure (OIL PSI)-----79  
 Oil temperature-----80  
 Oil Temperature (OIL °F)-----79  
 Omni Bearing Selector (OBS)-----506–507  
 Other Statistics-----236, 238  
 Outside Air Temperature (OAT)-----44, 65  
 Overspeed protection, autopilot-----392

**P**

Page groups-----29–32  
 Page menus-----27  
 Parallel Track-----211, 212  
 Pilot profiles-----37–38  
 PIREP-----304  
 Pitch Hold Mode (PIT)-----354  
 Pitch modes, flight director-----353–359  
 Pitch Reference-----354  
 Power-up page-----459  
 Power-up, system-----8  
 Primary Flight Display (PFD)-----2  
     Controls-----18–19  
     Softkeys-----20–22  
 Procedure examples, AFCS-----378–390  
 Procedure Loading Pages (PROC)-----32

**Q**

Quick tuning 121.500 MHz-----94

**R**

RAIM-----16, 230, 240, 241, 242, 505  
 Range-----153  
 Receiver Autonomous Integrity Monitoring-----16–17  
 Receiver Autonomous Integrity Monitoring (RAIM) --240  
 Required  
     Vertical Speed-----260  
     Vertical Speed Indicator-----260  
 Reversionary mode-----126  
 Reversionary Mode-----9–10  
 ROC-----328  
 Roll Hold Mode (ROL)-----370  
 Roll modes, flight director-----369–372  
 Roll Reference-----370  
 RVSI-----260, 261  
 RX indicator-----93

**S**

SafeTaxi-----393, 407, 410  
 SafeTaxi®-----393  
 SafeTaxi database-----411  
 SBAS-----240, 242, 505  
 Scheduler-----393–394, 457  
 Secure Digital (SD) card-----7, 459, 490  
 Selected Altitude-----44, 355, 357, 360, 364, 379  
 Selected Altitude Bug-----44  
 Selected Altitude Capture Mode-----355, 356, 357, 360  
 Selected Altitude Intercept Arc-----156  
 Selected Course-----45, 54, 373, 375  
 Selected Heading-----45, 54, 371  
 Selecting a COM radio-----92  
 Sequencing, automatic-----507  
 Service Class-----453  
 Servos-----4, 376  
 SIGMET-----291  
 SiriusXM  
     Radio-----274  
 Slip/Skid Indicator-----44, 48  
 Softkeys-----44  
     EIS-----83  
     LTNG-----289  
     MFD-----25  
     PFD-----20–22  
 Sort Flight Plans-----205  
 Speaker-----119  
 Splash screen, power-up-----8  
 Split COM Operation-----123  
 Standby frequency-----92, 95, 101  
     ADF-----110  
 Standby frequency field-----92  
 Stereo headsets-----119  
 Stuck microphone-----126  
 Sunrise-----237  
 Sunset-----237  
 SVS troubleshooting-----467  
 Symbols, map-----511  
 Synthetic vision (SVS)-----393, 394  
 System annunciations-----10, 471  
 System power-up-----8  
 System time-----44

**T**

Tachometer (RPM)-----79, 81, 83  
 TAF-----292  
 TAS-----485  
 Terminal procedures charts-----413, 433  
 Terrain-----479  
     Color indications-----513  
 Terrain-SVS-----322  
 TERRAIN-SVS-----72

Timer  
 Departure----- 41  
 Flight----- 40  
 Timer, PFD generic ----- 39  
 TOD ----- 259, 260, 266  
 TOPO DATA ----- 140, 141, 150  
 Top of Descent ----- 259, 260  
 TOPO SCALE ----- 142  
 Total flight hours----- 83  
 Track indicator----- 44  
 Traffic Annunciation ----- 45, 70  
 Traffic Information Service (TIS)----- 509–510  
 Voice alerts----- 70  
 Transponder----- 3  
 Transponder code entry ----- 117  
 Transponder data box ----- 87, 89  
 Transponder ground mode ----- 115  
 Transponder mode field ----- 115, 116  
 Transponder softkeys ----- 115  
 Transponder standby mode ----- 116  
 Transponder status box ----- 44  
 Trend Vector  
 Turn Rate----- 56  
 Trend Vector, Airspeed----- 46  
 Trim, Manual Electric ----- 347, 349, 376  
 Trip Planning----- 236, 237, 238  
 Trip statistics----- 237, 238  
 True Airspeed ----- 44, 46, 238  
 Tuning ADF frequencies ----- 111  
 Turbulence ----- 303  
 Turn anticipation ----- 507  
 Turn Rate Indicator ----- 44, 56  
 TX indicator----- 93

**U**

Unable to display chart ----- 413, 433  
 Unusual Attitudes----- 75  
 Updating Garmin databases ----- 411  
 Updating Jeppesen databases ----- 430

**V**

Vertical deviation ----- 362  
 Vertical deviation guidance ----- 222  
 Vertical Deviation Indicator (VDI)----- 52, 260, 261  
 Vertical navigation----- 221  
 Direct-to ----- 220  
 Vertical Navigation (VNV)  
 Flight control----- 360–364  
 Vertical Path Tracking Mode (VPTH) ----- 360–361, 384  
 Vertical speed guidance----- 222  
 Vertical speed indicator ----- 44, 51  
 Vertical Speed Mode (VS)----- 357  
 Vertical Speed Reference ----- 357  
 VFR code ----- 118

Video settings ----- 465  
 Video system ----- 393, 464  
 VNAV ----- 185  
 VNV ----- 259, 487, 504  
 VNV guidance  
 Disabling ----- 219  
 Enabling ----- 219  
 VNV indications ----- 68  
 VNV Target Altitude ----- 52, 360–363  
 VNV Target Altitude Capture Mode (ALTV) ----- 364  
 Voice alerts, TIS----- 70  
 Voice alerts, TIS Traffic----- 335, 474  
 VOL annunciation ----- 121  
 Volume level  
 ADF----- 110, 112  
 VOR  
 Nearest ----- 177–178  
 VOR selection----- 101  
 VSI----- 261  
 Vspeed references ----- 45, 47  
 VS TGT----- 221, 259

**W**

WAAS----- 243, 378, 483, 505  
 Waypoint  
 Automatic sequencing ----- 506, 507  
 Skipping ----- 507  
 Waypoint Pages (WPT)----- 30  
 Waypoint Selection Submenu-- 182, 189, 190, 194, 241  
 Wind ----- 130, 152  
 Wind data----- 45  
 WIND Softkey----- 297

**X**

XM  
 Radio----- 452  
 Receiver troubleshooting ----- 469  
 XM channel list----- 454  
 XM presets----- 456  
 XM radio ----- 454  
 XM radio entertainment ----- 124  
 XM radio volume----- 456  
 XM satellite radio ----- 452, 454  
 XM Satellite Radio----- 4  
 XM WX Satellite Weather  
 AIRMETs----- 291  
 SIGMETs----- 291

**Z**

Zoom  
 Auto----- 132

SYSTEM  
OVERVIEW

FLIGHT  
INSTRUMENTS

EIS

AUDIO PANEL  
& CNS

FLIGHT  
MANAGEMENT

HAZARD  
AVOIDANCE

AFCS

ADDITIONAL  
FEATURES

APPENDICES

INDEX

BLANK PAGE





# GARMIN<sup>®</sup>



Garmin International, Inc.  
1200 East 151st Street  
Olathe, KS 66062, U.S.A.  
p:913.397.8200  
f:913.397.8282

Garmin AT, Inc.  
2345 Turner Road SE  
Salem, OR 97302, U.S.A.  
p:503.391.3411  
f:503.364.2138

Garmin (Europe) Ltd.  
Liberty House, Bulls Copse Road  
Houndsdown Business Park  
Southampton, SO40 9RB, U.K.  
p:44/0870.8501241  
f:44/0870.8501251

Garmin Corporation  
No. 68, Jangshu 2nd Road  
Shijr, Taipei County, Taiwan  
p:886/02.2642.9199  
f:886/02.2642.9099

[www.garmin.com](http://www.garmin.com)